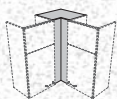
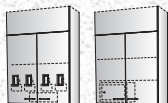

Table of Contents

**WALL – ATTACHED SOFFIT**



Shelf ..... 3-4

Bookshelf ..... 5

Display ..... 6-7

Corner ..... 8

Cubicle ..... 9-10

Forms ..... 10

Mail Cubicle ..... 11

Folder ..... 12

Media Integration ..... 13

Specialty ..... 13-15

Installation Accessories ..... 16











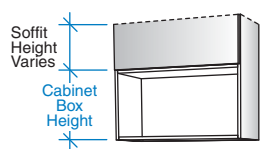



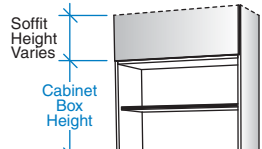

Design Details ..... 17

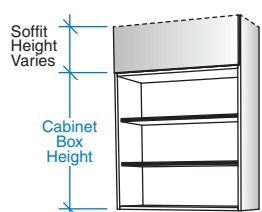
# WALL – ATTACHED SOFFIT

Commercial Cabinetry and Millwork

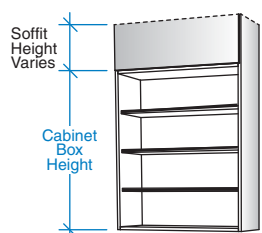

Height (H) denotes cabinet box height.  
Soffits available 6"-18" high in 1" increments.

| Shelf                                  |  | 12",16",18" HIGH:  | 12",16",18" HIGH:   | 12",16",18" HIGH:   |
|--|--|--|---|---|
|  | <p><b>W:</b> 12,15,18,21,24,27,30,33,36,39,42,45,48</p> <p><b>H:</b> 12,16,18,25,30,36,42,47</p> <p><b>D:</b> 14,18</p> <p>Adjustable Shelves (25H-47H only)</p> | <p><b>W:</b> 12,15,18</p> <p><b>H:</b> 12,16,18</p> <p><b>D:</b> 14,18</p> <p><b>25",30",36",42",47" HIGH:</b></p> <p><b>W:</b> 12,15,18,21,24</p> <p><b>H:</b> 25,30,36,42,47</p> <p><b>D:</b> 14,18</p> <p>Right Hinge Door</p> <p>Adjustable Shelves (25H-47H only)</p> | <p><b>W:</b> 12,15,18</p> <p><b>H:</b> 12,16,18</p> <p><b>D:</b> 14,18</p> <p><b>25",30",36",42",47" HIGH:</b></p> <p><b>W:</b> 12,15,18,21,24</p> <p><b>H:</b> 25,30,36,42,47</p> <p><b>D:</b> 14,18</p> <p>Left Hinge Door</p> <p>Adjustable Shelves (25H-47H only)</p> | <p><b>W:</b> 24,27,30,33,36</p> <p><b>H:</b> 12,16,18</p> <p><b>D:</b> 14,18</p> <p><b>25",30",36",42",47" HIGH:</b></p> <p><b>W:</b> 24,27,30,33,36,39,42,45,48</p> <p><b>H:</b> 25,30,36,42,47</p> <p><b>D:</b> 14,18</p> <p>Doors</p> <p>Adjustable Shelves (25H-47H only)</p> |
|  | <b>13101</b>   | <b>13120</b>   | <b>13121</b>  | <b>13129</b>  |
| <b>12H</b><br><b>16H</b><br><b>18H</b> |   |   |   |    |
| <b>25H</b>                             |   |   |   |    |
| <b>30H</b><br><b>36H</b>               |   |   |   |    |
| <b>42H</b><br><b>47H</b>               |   |   |   |    |

# WALL – ATTACHED SOFFIT

## Shelf

Height (H) denotes cabinet box height.  
Soffits available 6"-18" high in 1" increments.



### Shelf

**W:** 36,39,42,45,48  
**H:** 12,16,18,25,30,36,42,47  
**D:** 14,18

Center Divider  
Adjustable Shelves (25H-47H only)

**W:** 36,39,42,45,48  
**H:** 25,30,36,42,47  
**D:** 14,18

Doors  
Center Divider  
Adjustable Shelves

**W:** 36,39,42,45,48  
**H:** 16,18,25,30,36,42,47  
**D:** 14,18

Sliding Doors  
Center Divider  
Adjustable Shelves (25H-47H only)

### 13138

### 13181

### 13150

12H  
16H  
18H

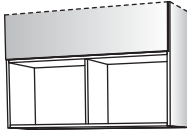

25H

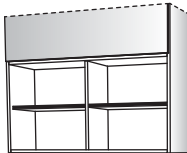

30H  
36H



42H  
47H



16H  
18H

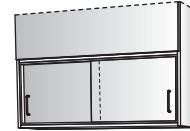

25H

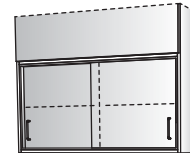



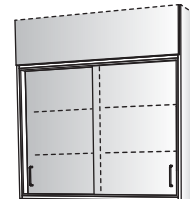





30H  
36H

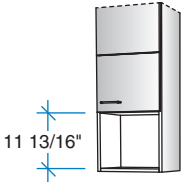
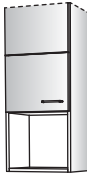

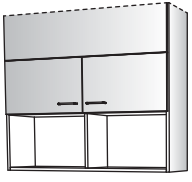
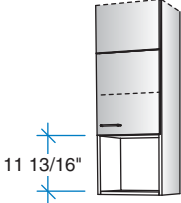
42H  
47H

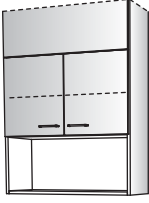

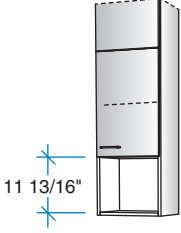
Height (H) denotes cabinet box height.  
Soffits available 6"-18" high in 1" increments.

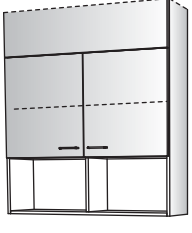
| Bookshelf                |   |  |  |  |
|--------------------------|---|--|--|--|
|                          | <p><b>W:</b> 12,15,18,21,24<br/><b>H:</b> 30,36,42,47<br/><b>D:</b> 14,18</p> <p>Right Hinge Door<br/>Open Compartment (11<sup>13</sup>/<sub>16</sub>"H)<br/>Adjustable Shelf in Upper<br/>Compartment (36H-47H only)</p> | <p><b>W:</b> 12,15,18,21,24<br/><b>H:</b> 30,36,42,47<br/><b>D:</b> 14,18</p> <p>Left Hinge Door<br/>Open Compartment (11<sup>13</sup>/<sub>16</sub>"H)<br/>Adjustable Shelf in Upper<br/>Compartment (36H-47H only)</p> | <p><b>W:</b> 30,33,36<br/><b>H:</b> 30,36,42,47<br/><b>D:</b> 14,18</p> <p>Doors<br/>Open Compartment (11<sup>13</sup>/<sub>16</sub>"H)<br/>Adjustable Shelf in Upper<br/>Compartment (36H-47H only)</p> | <p><b>W:</b> 39,42,45,48<br/><b>H:</b> 30,36,42,47<br/><b>D:</b> 14,18</p> <p>Doors<br/>Center Divider in Open<br/>Compartment<br/>Open Compartment (11<sup>13</sup>/<sub>16</sub>"H)<br/>Adjustable Shelf in Upper<br/>Compartment (36H-47H only)</p> |
|                          | <b>13184</b>  | <b>13185</b>   | <b>13186</b>   | <b>13187</b>   |
| <b>30H</b>               |  <p>11 13/16"</p>  |   |    |   |
| <b>36H</b>               |  <p>11 13/16"</p>  |   |    |   |
| <b>42H</b><br><b>47H</b> |  <p>11 13/16"</p>  |   |    |   |

# WALL – ATTACHED SOFFIT

## Display

Height (H) denotes cabinet box height.







Soffits available 6"-18" high in 1" increments.

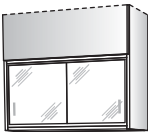
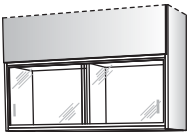
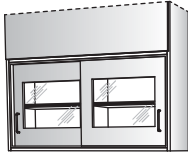
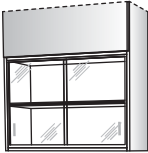
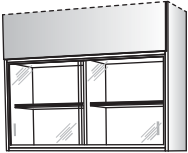
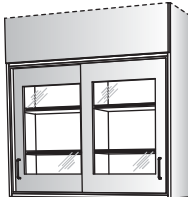

| Display                  |  |   |   |  |
|--------------------------|--|---|---|--|
|                          | <p><b>W:</b> 15,18,21,24<br/><b>H:</b> 25,30,36,42,47<br/><b>D:</b> 14,18</p> <p>Right Hinge Display Door<br/>Adjustable Shelves</p> | <p><b>W:</b> 15,18,21,24<br/><b>H:</b> 25,30,36,42,47<br/><b>D:</b> 14,18</p> <p>Left Hinge Display Door<br/>Adjustable Shelves</p> | <p><b>W:</b> 30,36<br/><b>H:</b> 25,30,36,42,47<br/><b>D:</b> 14,18</p> <p>Display Doors<br/>Adjustable Shelves</p> | <p><b>W:</b> 30,36,42,48<br/><b>H:</b> 25,30,36,42,47<br/><b>D:</b> 14,18</p> <p>Display Doors<br/>Center Divider<br/>Adjustable Shelves</p> |
|                          | <b>13130</b>   | <b>13131</b>  | <b>13136</b>  | <b>13182</b>   |
| <b>25H</b>               |  |   |   |  |
| <b>30H</b><br><b>36H</b> |  |   |   |  |
| <b>42H</b><br><b>47H</b> |  |   |   |  |

## Display

Height (H) denotes cabinet box height.  
Soffits available 6"-18" high in 1" increments.

|                          | Display  |   |   |
|--------------------------|--|---|---|
|                          | <p><b>W:</b> 30,36,42,48<br/><b>H:</b> 25,30,36,42,47<br/><b>D:</b> 14,18</p> <p>Sliding Display Doors<br/>Center Divider<br/>Adjustable Shelves</p> | <p><b>W:</b> 30,33,36<br/><b>H:</b> 16,18,25,30,36,42,47<br/><b>D:</b> 14,18</p> <p>Sliding Glass Doors<br/>Adjustable Shelves (25H-47H only)</p> | <p><b>W:</b> 39,42,45,48<br/><b>H:</b> 16,18,25,30,36,42,47<br/><b>D:</b> 14,18</p> <p>Sliding Glass Doors<br/>Center Divider<br/>Adjustable Shelves (25H-47H only)</p> |
|                          | 13154  | 13156   | 13158   |
| <b>16H</b><br><b>18H</b> |   |    |   |
| <b>25H</b>               |   |    |   |
| <b>30H</b><br><b>36H</b> |   |    |   |
| <b>42H</b><br><b>47H</b> |   |    |   |

# WALL – ATTACHED SOFFIT

## Corner

Height (H) denotes cabinet box height.  
Soffits available 6"-18" high in 1" increments.



### Corner – Blind

**14" DEEP:**  
**W:** 33,36  
**H:** 16,18,25,30,36, 42,47  
**D:** 14

**18" DEEP:**  
**W:** 36,39  
**H:** 16,18,25,30,36, 42,47  
**D:** 18

Left Hand Open Adjustable Shelves (25H-47H only)

**14" DEEP:**  
**W:** 33,36  
**H:** 16,18,25,30,36, 42,47  
**D:** 14

**18" DEEP:**  
**W:** 36,39  
**H:** 16,18,25,30,36, 42,47  
**D:** 18

Right Hand Open Adjustable Shelves (25H-47H only)

**14" DEEP:**  
**W:** 33,36  
**H:** 16,18,25,30,36, 42,47  
**D:** 14

**18" DEEP:**  
**W:** 36,39  
**H:** 16,18,25,30,36, 42,47  
**D:** 18

Right Hinge Door Adjustable Shelves (25H-47H only)

**14" DEEP:**  
**W:** 33,36  
**H:** 16,18,25,30,36, 42,47  
**D:** 14

**18" DEEP:**  
**W:** 36,39  
**H:** 16,18,25,30,36, 42,47  
**D:** 18

Left Hinge Door Adjustable Shelves (25H-47H only)

**14" DEEP:**  
**W:** 33,36  
**H:** 25,30,36,42,47  
**D:** 14

**18" DEEP:**  
**W:** 36,39  
**H:** 25,30,36,42,47  
**D:** 18

Right Hinge Display Door Adjustable Shelves

**14" DEEP:**  
**W:** 33,36  
**H:** 25,30,36,42,47  
**D:** 14

**18" DEEP:**  
**W:** 36,39  
**H:** 25,30,36,42,47  
**D:** 18

Left Hinge Display Door Adjustable Shelves

**13198**

**13199**

**13200**

**13201**

**13202**

**13203**

**16H**  
**18H**

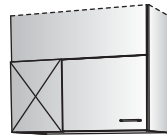
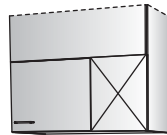
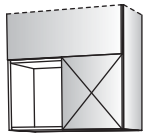

**25H**

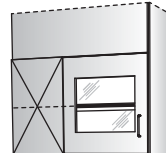
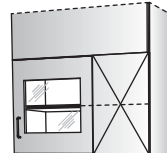
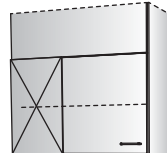
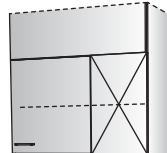
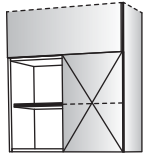

**30H**  
**36H**

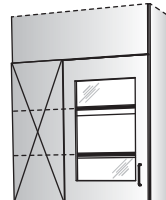
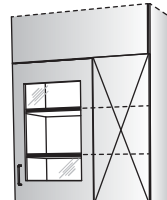
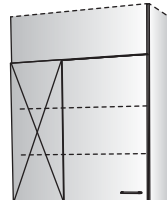
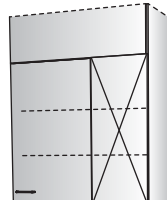
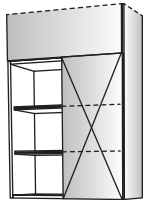



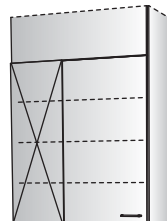
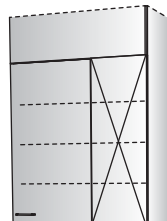
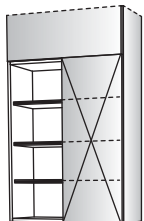







**42H**  
**47H**

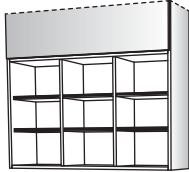

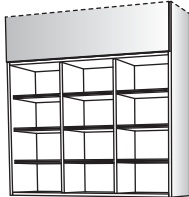
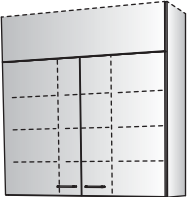

## Cubicle

Height (H) denotes cabinet box height.  
Soffits available 6"-18" high in 1" increments.

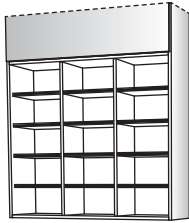
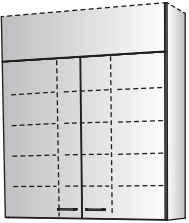

| Cubicle  |  | Cubicle  |   | Cubicle   |   | Cubicle  |   |
|--|--|--|---|---|---|--|---|
| <b>Compt. Widths</b><br>18W = 7 <sup>7</sup> / <sub>8</sub> "<br>21W = 9 <sup>3</sup> / <sub>8</sub> "<br>24W = 10 <sup>7</sup> / <sub>8</sub> " | <b>W:</b> 18,21,24<br><b>H:</b> 25,30,36,42,47<br><b>D:</b> 14,18<br><br>¾" Adjustable Cubicle Shelves<br>Compartment Spacing 3"H min. | <b>W:</b> 18,21,24<br><b>H:</b> 25,30,36,42,47<br><b>D:</b> 14,18<br><br>Right Hinge Door<br>¾" Adjustable Cubicle Shelves<br>Compartment Spacing 3"H min. | <b>W:</b> 18,21,24<br><b>H:</b> 25,30,36,42,47<br><b>D:</b> 14,18<br><br>Left Hinge Door<br>¾" Adjustable Cubicle Shelves<br>Compartment Spacing 3"H min. | <b>Compt. Widths</b><br>30W = 9"<br>36W = 11"<br>42W = 13"<br>48W = 15" | <b>W:</b> 30,36,42,48<br><b>H:</b> 25,30,36,42,47<br><b>D:</b> 14,18<br><br>¾" Adjustable Cubicle Shelves<br>Compartment Spacing 3"H min. | <b>W:</b> 30,36,42,48<br><b>H:</b> 25,30,36,42,47<br><b>D:</b> 14,18<br><br>Doors<br>¾" Adjustable Cubicle Shelves<br>Compartment Spacing 3"H min. |   |
|  | <b>13220</b>   | <b>13222</b>   | <b>13223</b>  |   | <b>13226</b>  | <b>13227</b>   |   |
|  | <b>25H</b><br><b>30H</b><br>6 Compts.  |   |    |   |    | <b>25H</b><br><b>30H</b><br>9 Compts.  |  |
| <b>36H</b><br>8 Compts.  |   |   |    | <b>36H</b><br>12 Compts.  |    |   |   |
| <b>42H</b><br><b>47H</b><br>10 Compts.   |   |   |    | <b>42H</b><br><b>47H</b><br>15 Compts.                                  |    |   |   |



# WALL – ATTACHED SOFFIT

## Cubicle / Forms

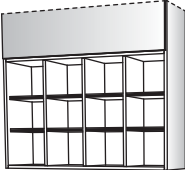
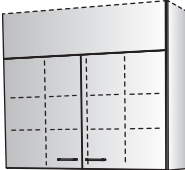
Height (H) denotes cabinet box height.  
Soffits available 6"-18" high in 1" increments.

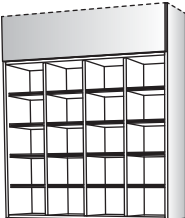
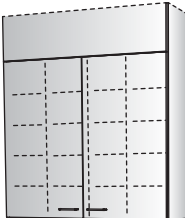

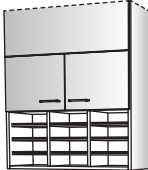
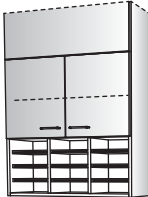

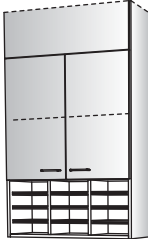





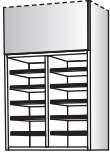

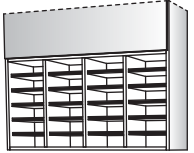
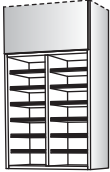
| Cubicle   |  |
|---|--|
| <b>Compt. Widths</b><br>36W = 8"<br>42W = 9½"<br>48W = 11"  | <p><b>W:</b> 36,42,48<br/><b>H:</b> 25,30,36,42,47<br/><b>D:</b> 14,18</p> <p>¾" Adjustable Cubicle Shelves<br/>Compartment Spacing 3"H min.</p>           |
|   | <p><b>W:</b> 36,42,48<br/><b>H:</b> 25,30,36,42,47<br/><b>D:</b> 14,18</p> <p>Doors<br/>¾" Adjustable Cubicle Shelves<br/>Compartment Spacing 3"H min.</p> |
|   | <p><b>13239</b>                      <b>13240</b></p>  |
| <p><b>25H</b><br/><b>30H</b><br/>12 Compts.</p>    |   |
| <p><b>36H</b><br/>16 Compts.</p>                 |   |
| <p><b>42H</b><br/><b>47H</b><br/>20 Compts.</p>  |   |

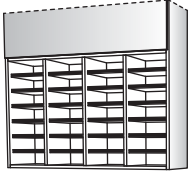
| Forms  |   |
|--|---|
| <b>Compt. Widths</b><br>30W = 9"<br>36W = 11"<br>42W = 13"<br>48W = 15"  | <p><b>W:</b> 30,36,42,48<br/><b>H:</b> 30,36,42,47<br/><b>D:</b> 14,18</p> <p>Upper Doors<br/>Adjustable Shelf in Upper Compartment (36H-47H only)<br/>¾" Adjustable, Equally Spaced Cubicle Shelves<br/>Compartment Spacing 3"H min.</p> |
|  | <p><b>13256</b></p>   |
| <p><b>30H</b><br/>12 Compts.</p>    |   |
| <p><b>36H</b><br/>12 Compts.</p>  |   |
| <p><b>42H</b><br/>12 Compts.</p>  |   |
| <p><b>47H</b><br/>12 Compts.</p>  |   |

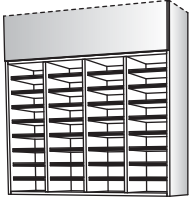
## Mail Cubicle

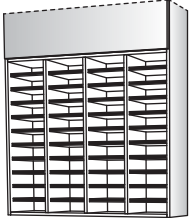
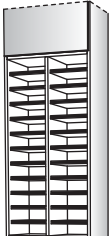
Height (H) denotes cabinet box height.  
Soffits available 6"-18" high in 1" increments.

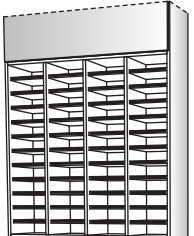
| Mail Cubicle   |  |  |
|--|--|--|
| Open, One Face   |  |  |
| <p><b>Compt. Widths</b><br/>21W = 9<sup>3</sup>/<sub>8</sub>"<br/>24W = 10<sup>7</sup>/<sub>8</sub>"<br/>30W = 13<sup>7</sup>/<sub>8</sub>"<br/>36W = 16<sup>7</sup>/<sub>8</sub>"</p> | <p><b>W:</b> 21,24,30,36<br/><b>H:</b> 25,30,36,42,47<br/><b>D:</b> 14,18</p> <p>Open, One Face<br/>¾" Adjustable, Equally Spaced Cubicle Shelves<br/>Compartment Spacing 3"H min.</p> |  |
| <p><b>Compt. Widths</b><br/>30W = 9"<br/>36W = 11"<br/>42W = 13"<br/>48W = 15"</p>   | <p><b>W:</b> 30,36,42,48<br/><b>H:</b> 25,30,36,42,47<br/><b>D:</b> 14,18</p> <p>Open, One Face<br/>¾" Adjustable, Equally Spaced Cubicle Shelves<br/>Compartment Spacing 3"H min.</p> |  |
| <p><b>Compt. Widths</b><br/>42W = 9<sup>1</sup>/<sub>2</sub>"<br/>48W = 11"</p>  | <p><b>W:</b> 42,48<br/><b>H:</b> 25,30,36,42,47<br/><b>D:</b> 14,18</p> <p>Open, One Face<br/>¾" Adjustable, Equally Spaced Cubicle Shelves<br/>Compartment Spacing 3"H min.</p>       |  |
| 13250  | 13251  | 13252  |
| <p><b>25H</b><br/>12 Compts.</p>    | <p><b>25H</b><br/>18 Compts.</p>    | <p><b>25H</b><br/>24 Compts.</p>    |
| <p><b>30H</b><br/>14 Compts.</p>   | <p><b>30H</b><br/>21 Compts.</p>   | <p><b>30H</b><br/>28 Compts.</p>   |
| <p><b>36H</b><br/>18 Compts.</p>    | <p><b>36H</b><br/>27 Compts.</p>    | <p><b>36H</b><br/>36 Compts.</p>  |
| <p><b>42H</b><br/>22 Compts.</p>    | <p><b>42H</b><br/>33 Compts.</p>    | <p><b>42H</b><br/>44 Compts.</p>  |
| <p><b>47H</b><br/>24 Compts.</p>    | <p><b>47H</b><br/>36 Compts.</p>    | <p><b>47H</b><br/>48 Compts.</p>  |

# WALL – ATTACHED SOFFIT

## Folder

Height (H) denotes cabinet box height. Soffits available 6"-18" high in 1" increments.

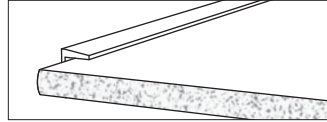

1/4"-thick folder shelves are held securely with translucent, low profile shelf supports. All edges unfinished. Front edge unfinished and shaped.



### Folder

**W:** 21,24,30,36  
**H:** 25,30,36,42,47  
**D:** 14,18

1/4" Folder Shelves,  
Adjustable and Removable  
on 1 1/4" Centers  
Compartments 2 1/4"H min.

**W:** 30,36,42,48  
**H:** 25,30,36,42,47  
**D:** 14,18

1/4" Folder Shelves,  
Adjustable and Removable  
on 1 1/4" Centers  
Compartments 2 1/4"H min.

**W:** 42,48  
**H:** 25,30,36,42,47  
**D:** 14,18

1/4" Folder Shelves,  
Adjustable and Removable  
on 1 1/4" Centers  
Compartments 2 1/4"H min.

### 13241

**25H**  
18 Compts.



**30H**  
22 Compts.



**36H**  
28 Compts.



**42H**  
32 Compts.



**47H**  
36 Compts.

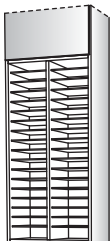

### 13242

**25H**  
27 Compts.



**30H**  
33 Compts.



**36H**  
42 Compts.



**42H**  
48 Compts.



**47H**  
54 Compts.



### 13243

**25H**  
36 Compts.

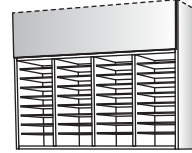

**30H**  
44 Compts.

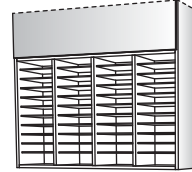

**36H**  
56 Compts.





**42H**  
64 Compts.



**47H**  
72 Compts.



| Media Integration   |  |
|---|--|
| <p><b>W:</b> 21,24<br/><b>H:</b> 30<br/><b>D:</b> 18</p> <p>Right Hinge Display Door<br/>Black Vent Grille<br/>Adjustable Shelves with Wire Management Slot</p> | <p><b>W:</b> 21,24<br/><b>H:</b> 30<br/><b>D:</b> 18</p> <p>Left Hinge Display Door<br/>Black Vent Grille<br/>Adjustable Shelves with Wire Management Slot</p> |
| <b>13500</b>  | <b>13501</b>   |
| <b>30H</b>  |  |
|    |   |

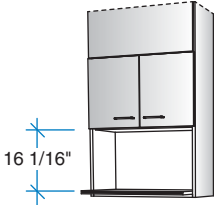









| Specialty  |  |
|--|--|
| Microwave  |  |
| <p><b>W:</b> 27,30,33,36<br/><b>H:</b> 30,36<br/><b>D:</b> 14,18</p> <p>20"-Deep Attachable Microwave Shelf<br/>Accommodates Typical 1 cu.ft. - 2 cu.ft.<br/>Microwave</p> |  |
| <b>13149</b>   |  |
| <b>30H</b><br><b>36H</b>   |  |
|   |  |

# WALL – ATTACHED SOFFIT

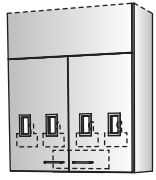

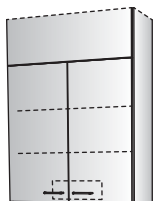
## Specialty



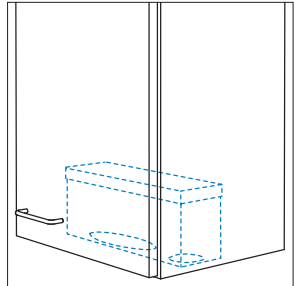
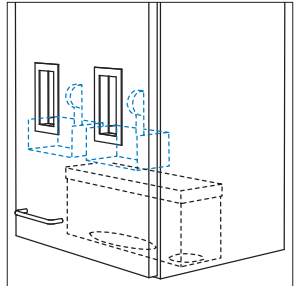

Height (H) denotes cabinet box height.  
Soffits available 6"-18" high in 1" increments.

| Specialty  |   |  | Specialty  |   |   |
|--|---|--|--|---|---|
| Dispensing – Towel/Cup   |   |  | Dispensing – Towel/Cup/Glove/Tissue  |   |   |
| <p><b>W:</b> 18,21,24<br/><b>H:</b> 25,30,36<br/><b>D:</b> 14,18</p> <p>Right Hinge Door<br/>Towel/Cup Dispenser<br/>Adjustable Shelves</p>  | <p><b>W:</b> 18,21,24<br/><b>H:</b> 25,30,36<br/><b>D:</b> 14,18</p> <p>Left Hinge Door<br/>Towel/Cup Dispenser<br/>Adjustable Shelves</p>  | <p><b>W:</b> 27,30,33,36,39,<br/>42,45,48<br/><b>H:</b> 25,30,36<br/><b>D:</b> 14,18</p> <p>Doors<br/>Towel/Cup Dispenser<br/>Adjustable Shelves</p> | <p><b>W:</b> 18,21,24<br/><b>H:</b> 25,30,36<br/><b>D:</b> 14,18</p> <p>Right Hinge Door<br/>Towel/Cup and<br/>Glove/Tissue<br/>Dispensers<br/>Adjustable Shelf<br/>(36H only)</p> | <p><b>W:</b> 18,21,24<br/><b>H:</b> 25,30,36<br/><b>D:</b> 14,18</p> <p>Left Hinge Door<br/>Towel/Cup and<br/>Glove/Tissue<br/>Dispensers<br/>Adjustable Shelf<br/>(36H only)</p> | <p><b>W:</b> 36,39,42,45,48<br/><b>H:</b> 25,30,36<br/><b>D:</b> 14,18</p> <p>Doors<br/>Towel/Cup and<br/>Glove/Tissue<br/>Dispensers<br/>Adjustable Shelf<br/>(36H only)</p> |
| <b>13122</b>   | <b>13123</b>  | <b>13126</b>   | <b>13124</b>   | <b>13125</b>  | <b>13127</b>  |
| <p><b>25H</b></p>                         | <p><b>25H</b><br/><b>30H</b></p>    |  |  |   |   |
| <p><b>30H</b><br/><b>36H</b></p>    | <p><b>36H</b></p>             |  |  |   |   |
|  <p><b>TOWEL/CUP DISPENSER</b><br/>Bottom-access dispensing of paper towels and 5 oz. cups.</p>   |   |  |  <p><b>GLOVE/TISSUE DISPENSER</b><br/>Face-of-door access for gloves or tissues.</p>          |   |   |

## Specialty

Height (H) denotes cabinet box height.  
Soffits available 6"-18" high in 1" increments.

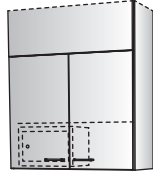
The narcotics locker and cabinet door locks are keyed differently and require separate keys.  
Both doors to be keyed differently from all other cabinets.

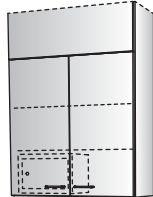
| Specialty        |   |  |   |
|------------------|---|--|---|
| Narcotics Locker |   |  |   |
|                  | <p><b>W:</b> 18,21,24<br/><b>H:</b> 25,30,36<br/><b>D:</b> 14,18</p> <p>Locked Right Hinge Door<br/>Locked Steel Narcotics Locker<br/>Fixed Shelf<br/>Adjustable Shelf (36H only)</p> | <p><b>W:</b> 18,21,24<br/><b>H:</b> 25,30,36<br/><b>D:</b> 14,18</p> <p>Locked Left Hinge Door<br/>Locked Steel Narcotics Locker<br/>Fixed Shelf<br/>Adjustable Shelf (36H only)</p> | <p><b>W:</b> 30,36,39,42,45,48<br/><b>H:</b> 25,30,36<br/><b>D:</b> 14,18</p> <p>Locked Doors<br/>Locked Steel Narcotics Locker<br/>Fixed Shelf<br/>Adjustable Shelf (36H only)</p> |
|                  | 13290   | 13291  | 13294   |
| 25H<br>30H       |    |   |    |
| 36H              |    |   |    |

# WALL – ATTACHED SOFFIT

## Installation Accessories

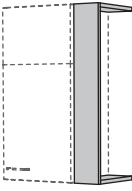
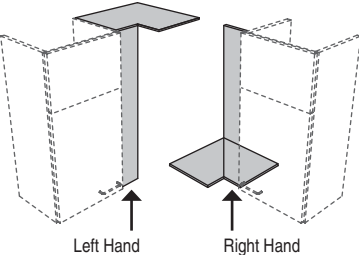

| Vertical Scribe  | Front Filler   | Corner Filler/Closure   |
|--|--|---|
| <p><b>W:</b> 00<br/> <b>H:</b> 12,16,18,25,30,36,42,47<br/> <b>D:</b> 14,18</p> <p>Field Trim to Fit<br/>                     Actual Thickness=3/4"<br/>                     Actual Depth=3"<br/>                     Edgebanding: One Long Edge in Casebody<br/>                     Trim Color and 0.5mm Thickness</p> | <p><b>W:</b> 02,03,06,09,12<br/> <b>H:</b> 12,16,18,25,30,36,42,47<br/> <b>D:</b> 14,18</p> <p>Field Trim to Fit<br/>                     Includes Top and Bottom Closure Panels<br/>                     Edgebanding: Two Short Edges in Casebody<br/>                     Trim Color and 0.5mm Thickness</p> | <p><b>W:</b> 02,03,06,09,12<br/> <b>H:</b> 12,16,18,25,30,36,42,47<br/> <b>D:</b> 14,18</p> <p>Field Trim to Fit<br/>                     Edgebanding (Corner Filler): Two Short Edges<br/>                     in Casebody Trim Color and 0.5mm Thickness<br/>                     Edgebanding (Closure): None</p> |
| 15802  | 15803  | 15805   |
|    |   |    |

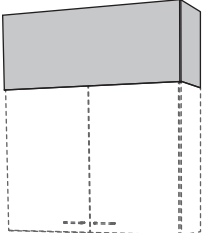
| Soffit Extension  |
|---|
| <p><b>W:</b> 12,15,18,21,24,27,30,<br/>                     33,36,39,42,45,48<br/> <b>H:</b> 6"-34" in 1" increments<br/> <b>D:</b> 14,18</p> <p>Edgebanding (Box): All Edges in Casebody<br/>                     Trim Color and Thickness<br/>                     Edgebanding (Soffit Panel): All Edges in<br/>                     Door/Drawer Trim Color and Thickness</p> |
| 15824   |
|   |



### ATTACHED SOFFIT

Stevens Advantage attached soffit units are designed with integral soffit ends, eliminating the need for on-the-job fabrication of soffit structures. The soffit panels align with door reveals and can be removed for easy installation. Cabinet support rails in the upper section are set down to allow for easy adjustment of the end panels for the perfect fit. Soffit heights are set to 12" as a default but can be specified from 6"-18" high in 1" increments.

