



UPDATE HISTORY

Valance – Streamlined Section



This UPDATE HISTORY outlines changes made to the Valance – Streamlined section of the Stevens Advantage Commercial Cabinetry and Millwork catalog since it was published in November 2017.

The most recent updates are shown first.

Go to stevensadvantage.com

→ RESOURCES

→ Commercial Casework

to view/download/print
the most current catalog sections.

Later updates supercede earlier updates.

(Revisions shown in **RED**)

UPDATE HISTORY

Valance – Streamlined Section



MARCH 2018			
MODEL #	TYPE OF UPDATE	DESCRIPTION OF UPDATE	CATALOG PAGE #
19290	Dimension	Deleted 15W	14
19291	Dimension	Deleted 15W	14

JANUARY 2018			
MODEL #	TYPE OF UPDATE	DESCRIPTION OF UPDATE	CATALOG PAGE #
19122	Dimension	Deleted 10D; added 21W, 24W, 18D	5
19123	Dimension	Deleted 10D; added 21W, 24W, 18D	5
19124	Dimension	Deleted 10D; added 21W, 24W, 18D	5
19125	Dimension	Deleted 10D; added 21W, 24W, 18D	5
19126	Dimension	Deleted 10D; added 27W, 30W, 33W, 39W, 42W, 45W, 48W, 18D	5
19127	Dimension	Deleted 10D; added 39W, 42W, 45W, 48W, 18D	5

Table of Contents

VALANCE – STREAMLINED

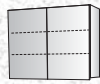

Shelf 3



Display 4



Dispensing 5



Corner – Blind/Diagonal/L-Shaped..... 6-8



Cubicle 9



Pass-Thru Mail Cubicle 10-11



Pass-Thru 12-13



Narcotics Locker 14



Media Integration 15



Above Refrigerator 15

Streamlined Valance Details..... 16

VALANCE – STREAMLINED

Commercial Cabinetry and Millwork



VALANCE – STREAMLINED



Display

Doors extend 1" below cabinet to allow opening without pull hardware.
Height (H) denotes cabinet box height.

W H D
15 25 14
18 30 18
21 36
24 42
47

Right Hinge
Display Door

W H D
15 25 14
18 30 18
21 36
24 42
47

Left Hinge
Display Door

W H D
30 25 14
36 30 18
36
42
47

Display Doors

W H D
30 25 14
36 30 18
42 36
48 42
47

Display Doors
Center Divider

19130

19131

19136

19182

25H
Adjustable
Shelf/
Shelves

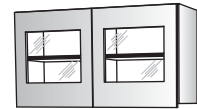
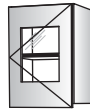
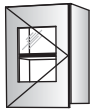

30H
36H
Adjustable
Shelves

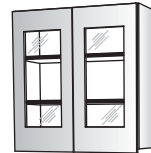
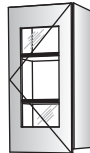
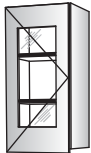

42H
47H
Adjustable
Shelves

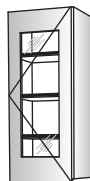
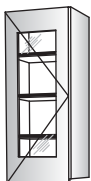

Dispensing

Doors extend 1" below cabinet to allow opening without pull hardware.
Height (H) denotes cabinet box height.

Towel/Cup			Towel/Cup/Glove/Tissue											
W	H	D	W	H	D	W	H	D	W	H	D			
18	25	14	18	25	14	27	25	14	18	25	14	36	25	14
21	30	14	21	30	14	30	30	14	21	30	14	39	30	14
24	36	18	24	36	18	33	36	18	24	36	18	42	36	18
						36						45		
						39						48		
						42								
						45								
						48								
Right Hinge Door Towel/Cup Dispenser	Left Hinge Door Towel/Cup Dispenser	Doors Towel/Cup Dispenser	Right Hinge Door Towel/Cup and Glove/Tissue Dispensers	Left Hinge Door Towel/Cup and Glove/Tissue Dispensers	Doors Towel/Cup and Glove/Tissue Dispensers									
19122	19123	19126	19124	19125	19127									

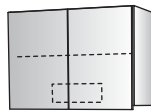
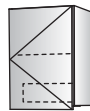
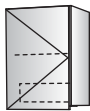

25H
Adjustable
Shelf

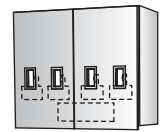
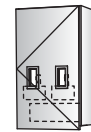
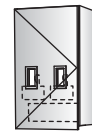

25H
30H

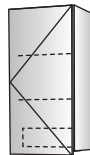
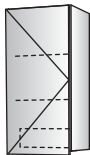

30H
36H
Adjustable
Shelves

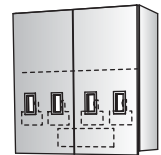
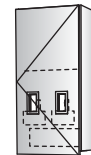
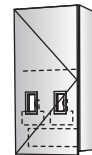

36H
Adjustable
Shelf

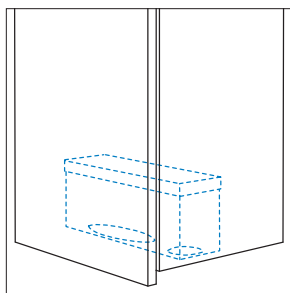

TOWEL/CUP DISPENSER

Bottom-access dispensing of paper towels and 5 oz. cups.

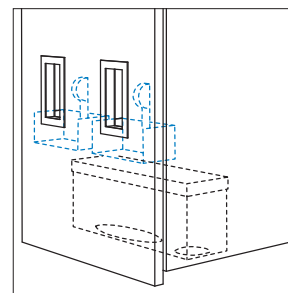

GLOVE/TISSUE DISPENSER

Face-of-door access for gloves or tissues.

VALANCE – STREAMLINED

Corner – Blind

Doors extend 1" below cabinet to allow opening without pull hardware.
Height (H) denotes cabinet box height.



W	H	D
33	16	14
36	18	
	25	
	30	
	36	
	42	
	47	

W	H	D
36	16	18
39	18	
	25	
	30	
	36	
	42	
	47	

Right Hinge Door

W	H	D
33	16	14
36	18	
	25	
	30	
	36	
	42	
	47	

W	H	D
36	16	18
39	18	
	25	
	30	
	36	
	42	
	47	

Left Hinge Door

W	H	D
33	25	14
36	30	
	36	
	42	
	47	

W	H	D
36	25	18
39	30	
	36	
	42	
	47	

Right Hinge Display Door

W	H	D
33	25	14
36	30	
	36	
	42	
	47	

W	H	D
36	25	18
39	30	
	36	
	42	
	47	

Left Hinge Display Door

19200

19201

19202

19203

16H
18H

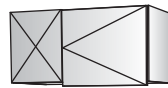

25H
Adjustable Shelf

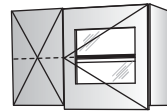
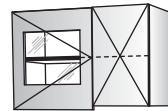
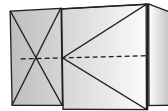
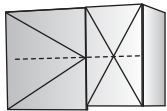

30H
36H
Adjustable Shelves

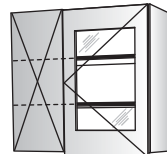
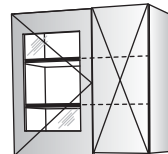
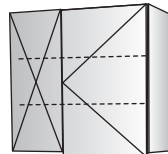
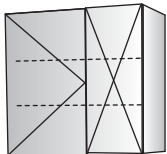

42H
47H
Adjustable Shelves

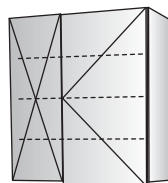
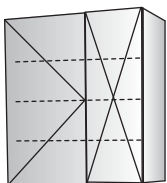



VALANCE – STREAMLINED

Corner – Diagonal

Doors extend 1" below cabinet to allow opening without pull hardware.
Height (H) denotes cabinet box height.

W	H	D
25	25	14
	30	
	36	
	42	
	47	

28	25	18
	30	
	36	
	42	
	47	

Right Hinge Door

W	H	D
25	25	14
	30	
	36	
	42	
	47	

28	25	18
	30	
	36	
	42	
	47	

Left Hinge Door

W	H	D
25	30	14
	36	
	42	
	47	

28	30	18
	36	
	42	
	47	

Right Hinge Door
2 Lazy Susans

W	H	D
25	30	14
	36	
	42	
	47	

28	30	18
	36	
	42	
	47	

Left Hinge Door
2 Lazy Susans

19211

19212

19213

19214

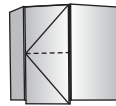
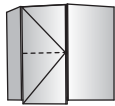

25H
Fixed Shelf

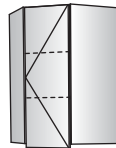
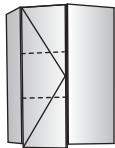

30H
36H
Fixed Shelves

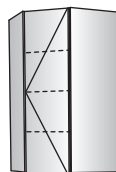
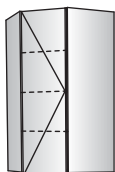

42H
47H
Fixed Shelves

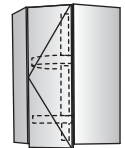
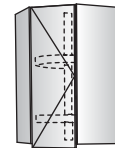

30H
36H

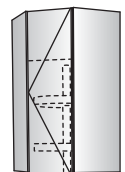
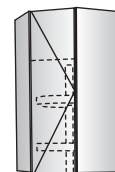

42H
47H
Fixed Shelf

VALANCE – STREAMLINED

Corner – L-Shaped

Doors extend 1" below cabinet to allow opening without pull hardware.
Height (H) denotes cabinet box height.



W	H	D
26	25	14
	30	
	36	
	42	
	47	

W	H	D
29	25	18
	30	
	36	
	42	
	47	

Right Hinge
Folding Door

19215

W	H	D
26	25	14
	30	
	36	
	42	
	47	

W	H	D
29	25	18
	30	
	36	
	42	
	47	

Left Hinge
Folding Door

19216

W	H	D
26	30	14
	36	
	42	
	47	

W	H	D
29	30	18
	36	
	42	
	47	

Right Hinge
Folding Door
2 Lazy Susans

19217

W	H	D
26	30	14
	36	
	42	
	47	

W	H	D
29	30	18
	36	
	42	
	47	

Left Hinge
Folding Door
2 Lazy Susans

19218

25H
Fixed Shelf

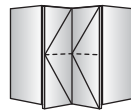
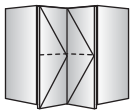

30H
36H
Fixed Shelves

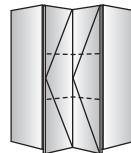
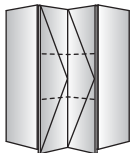

30H
36H

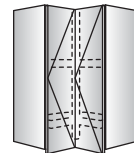
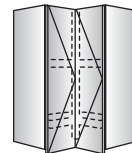

42H
47H
Fixed Shelves

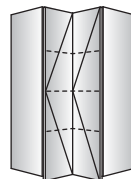
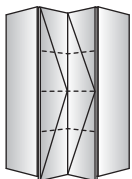

42H
47H
Fixed Shelf

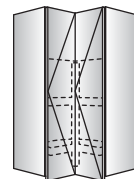
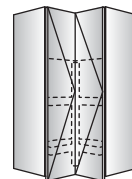

Doors extend 1" below cabinet to allow opening without pull hardware.
Height (H) denotes cabinet box height.

Compt. Widths	W	H	D	W	H	D
7 ⁷ / ₈ "	18	25	14	18	25	14
9 ³ / ₈ "	21	30	18	21	30	18
10 ⁷ / ₈ "	24	36	18	24	36	18
		42			42	
		47			47	

Right Hinge Door
3/4" Adjustable
Cubicle Shelves

Left Hinge Door
3/4" Adjustable
Cubicle Shelves

Compt. Widths	W	H	D
9"	30	25	14
11"	36	30	18
13"	42	36	
15"	48	42	
		47	

Doors
3/4" Adjustable
Cubicle Shelves

Compt. Widths	W	H	D
8"	36	25	14
9 ¹ / ₂ "	42	30	18
11"	48	36	
		42	
		47	

Doors
3/4" Adjustable
Cubicle Shelves

19222	19223	19227	19240
--------------	--------------	--------------	--------------

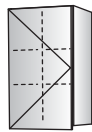

25H
6 Compts.
6³/₄"H

30H
6 Compts.
8"H

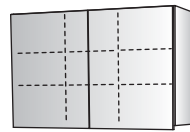

25H
9 Compts.
6³/₄"H

30H
9 Compts.
8"H

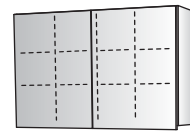

25H
12 Compts.
6³/₄"H

30H
12 Compts.
8"H

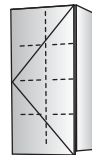
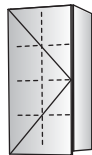

36H
8 Compts.
8"H

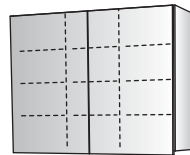

36H
12 Compts.
8"H

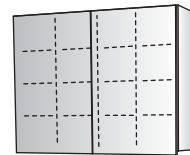

36H
16 Compts.
8"H

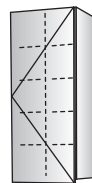
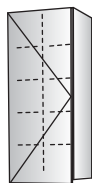

42H
10 Compts.
6³/₄"H

47H
10 Compts.
8"H

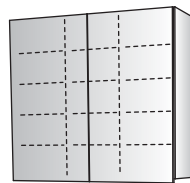

42H
15 Compts.
6³/₄"H

47H
15 Compts.
8"H

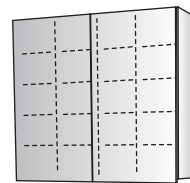

42H
20 Compts.
6³/₄"H

47H
20 Compts.
8"H

VALANCE – STREAMLINED

Pass-Thru Mail Cubicle – Doors One Face

Doors extend 1" below cabinet to allow opening without pull hardware.
 Height (H) denotes cabinet box height.
 Minimum 3" compartment height.



Doors One Face

Compt. Widths	W	H	D
9 3/8"	21	25	14
10 7/8"	24	30	18
		36	
		42	
		47	

Right Hinge Door One Face
 3/4" Adjustable, Equally Spaced Cubicle Shelves

19257

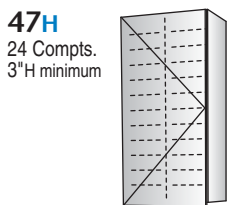
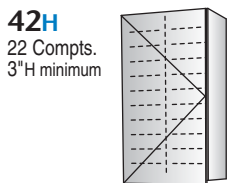
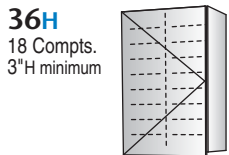
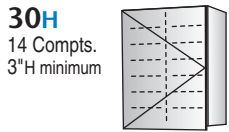
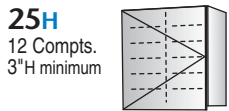

Compt. Widths	W	H	D
9 3/8"	21	25	14
10 7/8"	24	30	18
		36	
		42	
		47	

Left Hinge Door One Face
 3/4" Adjustable, Equally Spaced Cubicle Shelves

19258

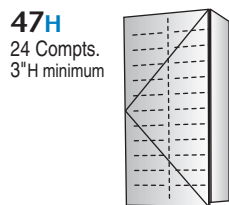
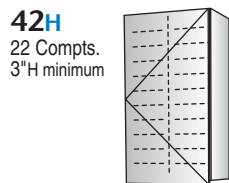
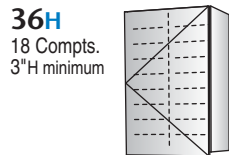
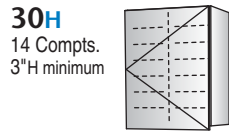
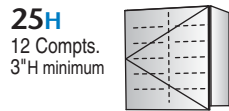

Compt. Widths	W	H	D
13 7/8"	30	25	14
16 7/8"	36	30	18
		36	
		42	
		47	

Doors One Face
 3/4" Adjustable, Equally Spaced Cubicle Shelves

19259

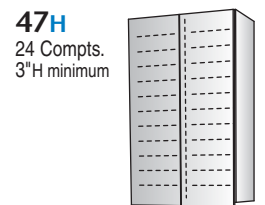
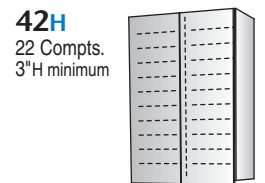
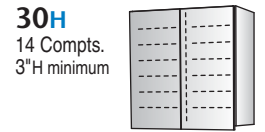
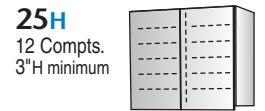

Pass-Thru Mail Cubicle – Doors One Face

Doors extend 1" below cabinet to allow opening without pull hardware.
Height (H) denotes cabinet box height.
Minimum 3" compartment height.

Doors One Face

Compt. Widths	W	H	D
9"	30	25	14
11"	36	30	18
13"	42	36	
15"	48	42	
		47	

Doors One Face
3/4" Adjustable, Equally Spaced Cubicle Shelves

Compt. Widths	W	H	D
9 1/2"	42	25	14
11"	48	30	18
		36	
		42	
		47	

Doors One Face
3/4" Adjustable, Equally Spaced Cubicle Shelves

19260



25H
18 Compts.
3"H minimum



30H
21 Compts.
3"H minimum



36H
27 Compts.
3"H minimum



42H
33 Compts.
3"H minimum

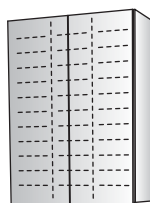

47H
36 Compts.
3"H minimum

19261



25H
24 Compts.
3"H minimum



30H
28 Compts.
3"H minimum



36H
36 Compts.
3"H minimum

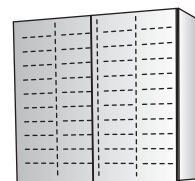



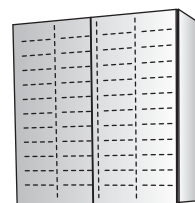







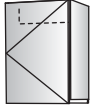

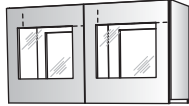
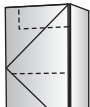

42H
44 Compts.
3"H minimum

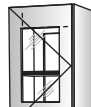

47H
48 Compts.
3"H minimum

Pass-Thru – Doors Two Faces

Doors extend 1" below cabinet to allow opening without pull hardware.
Height (H) denotes cabinet box height.

									Doors Two Faces											
W	H	D	W	H	D	W	H	D	W	H	D									
12	25	14	30	25	14	15	25	14	30	25	14									
15	30	18	36	30	18	18	30	18	36	30	18									
18	36		42	36		21	36		42	36										
21			48			24			48											
24																				
Right Hinge Door, Front Face Left Hinge Door, Back Face			Doors Two Faces Center Divider			Right Hinge Display Door, Front Face Left Hinge Display Door, Back Face			Display Doors Two Faces Center Divider											
19275			19277			19278			19282											
 Front Face View			 Back Face View			 			 Front Face View			 Back Face View			 			25H		
 Back Face View			 			 Back Face View			 Back Face View			 			30H Adjustable Shelf/Shelves					
 Front Face View			 Back Face View			 			 Front Face View			 Back Face View			 			36H Adjustable Shelves		

VALANCE – STREAMLINED



Narcotics Locker

Doors extend 1" below cabinet to allow opening without pull hardware.
 Height (H) denotes cabinet box height.
 The narcotics locker and cabinet door locks are keyed differently and require separate keys.
 Both doors to be keyed differently from all other cabinets.

W	H	D
18	25	14
18	30	18
21	36	
24		

Lockable Right Hinge Door
 Lockable Steel Narcotics Locker

W	H	D
18	25	14
18	30	18
21	36	
24		

Lockable Left Hinge Door
 Lockable Steel Narcotics Locker

W	H	D
30	25	14
36	30	18
39	36	
42		
45		
48		

Lockable Doors
 Lockable Steel Narcotics Locker

19290

19291

19294

25H
30H
 Fixed Shelf

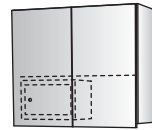

36H
 Fixed Shelf
 Adjustable Shelf

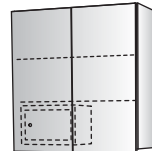
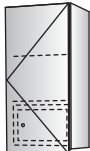
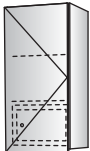





VALANCE – STREAMLINED

Media Integration/Above Refrigerator

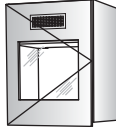
Doors extend 1" below cabinet to allow opening without pull hardware.
Height (H) denotes cabinet box height.

Media Integration		
W	H	D
21	30	18
24		
Right Hinge Display Door Black Vent Grille Adjustable Shelves with Wire Management Slot		Left Hinge Display Door Black Vent Grille Adjustable Shelves with Wire Management Slot
19500		
19501		
		
		

30H

Above Refrigerator		
W	H	D
30	12	14
33	16	18
36	18	24
39		
Sizes appropriate for use above refrigerator		
19103		
		
		12H
		16H
		18H

VALANCE – STREAMLINED

Streamlined Valance Details



STREAMLINED VALANCE DETAILS

