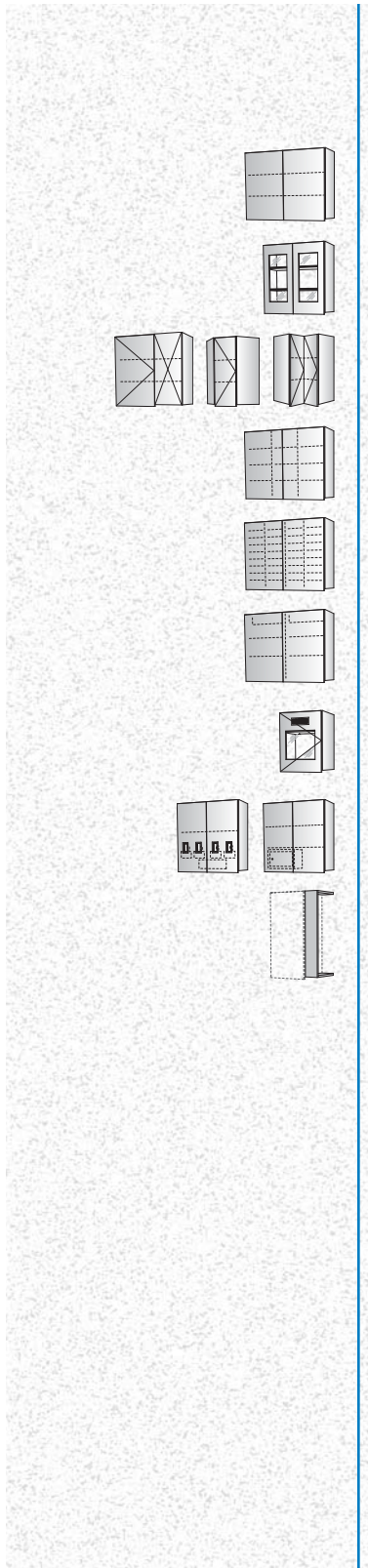

Table of Contents

VALANCE – STREAMLINED









Shelf	3
Display	4
Corner	5-7
Cubicle	8
Pass-Thru Mail Cubicle	9-10
Pass-Thru	11-12
Media Integration	13
Specialty.....	13-16
Installation Accessories	17-18
Design Details.....	19

VALANCE – STREAMLINED

Commercial Cabinetry and Millwork

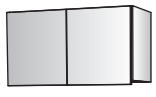
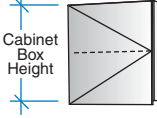
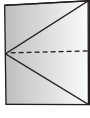
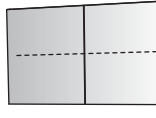
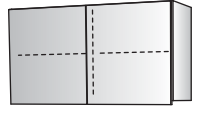
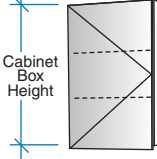

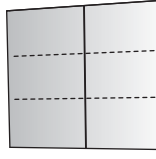
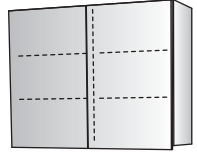
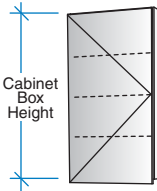
Doors extend 1" below cabinet to allow opening without pull hardware.
Height (H) denotes cabinet box height.

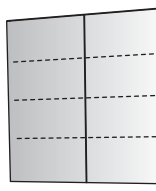
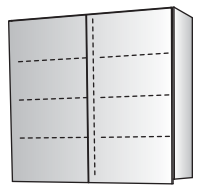
Shelf				
	<p>12",16",18" HIGH: W: 12,15,18 H: 12,16,18 D: 14,18</p> <p>25",30",36",42",47" HIGH: W: 12,15,18,21,24 H: 25,30,36,42,47 D: 14,18</p> <p>Right Hinge Door Adjustable Shelves (25H-47H only)</p>	<p>12",16",18" HIGH: W: 12,15,18 H: 12,16,18 D: 14,18</p> <p>25",30",36",42",47" HIGH: W: 12,15,18,21,24 H: 25,30,36,42,47 D: 14,18</p> <p>Left Hinge Door Adjustable Shelves (25H-47H only)</p>	<p>12",16",18" HIGH: W: 24,27,30,33,36 H: 12,16,18 D: 14,18</p> <p>25",30",36",42",47" HIGH: W: 24,27,30,33,36,39, 42,45,48 H: 25,30,36,42,47 D: 14,18</p> <p>Doors Adjustable Shelves (25H-47H only)</p>	<p>W: 36,39,42,45,48 H: 25,30,36,42,47 D: 14,18</p> <p>Doors Center Divider Adjustable Shelves</p>
	19120	19121	19129	19181
12H 16H 18H				
25H				
30H 36H				
42H 47H				

VALANCE – STREAMLINED







Display

Doors extend 1" below cabinet to allow opening without pull hardware.
Height (H) denotes cabinet box height.

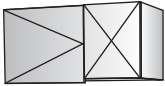
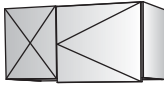
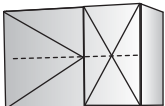
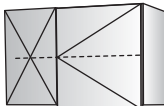
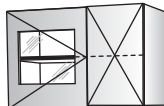
	Display			
	<p>W: 15,18,21,24 H: 25,30,36,42,47 D: 14,18</p> <p>Right Hinge Display Door Adjustable Shelves</p>	<p>W: 15,18,21,24 H: 25,30,36,42,47 D: 14,18</p> <p>Left Hinge Display Door Adjustable Shelves</p>	<p>W: 30,36 H: 25,30,36,42,47 D: 14,18</p> <p>Display Doors Adjustable Shelves</p>	<p>W: 30,36,42,48 H: 25,30,36,42,47 D: 14,18</p> <p>Display Doors Center Divider Adjustable Shelves</p>
	19130	19131	19136	19182
25H				
30H 36H				
42H 47H				

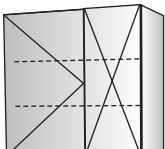
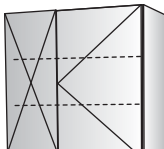
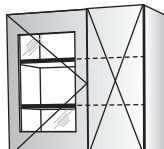
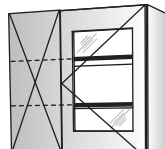
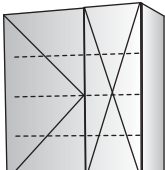
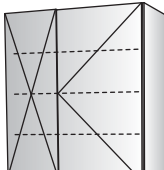
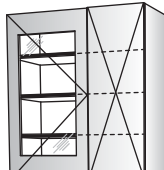
Doors extend 1" below cabinet to allow opening without pull hardware.
Height (H) denotes cabinet box height.

Corner – Blind				
	14" DEEP: W: 33,36 H: 16,18,25,30,36,42,47 D: 14 18" DEEP: W: 36,39 H: 16,18,25,30,36,42,47 D: 18 Right Hinge Door Adjustable Shelves (25H-47H only)	14" DEEP: W: 33,36 H: 16,18,25,30,36,42,47 D: 14 18" DEEP: W: 36,39 H: 16,18,25,30,36,42,47 D: 18 Left Hinge Door Adjustable Shelves (25H-47H only)	14" DEEP: W: 33,36 H: 25,30,36,42,47 D: 14 18" DEEP: W: 36,39 H: 25,30,36,42,47 D: 18 Right Hinge Display Door Adjustable Shelves	14" DEEP: W: 33,36 H: 25,30,36,42,47 D: 14 18" DEEP: W: 36,39 H: 25,30,36,42,47 D: 18 Left Hinge Display Door Adjustable Shelves
	19200	19201	19202	19203
16H 18H				
25H				
30H 36H				
42H 47H				

VALANCE – STREAMLINED



Corner

Doors extend 1" below cabinet to allow opening without pull hardware.
Height (H) denotes cabinet box height.

Corner – Diagonal

14" DEEP:
W: 25
H: 25,30,36,42,47
D: 14

18" DEEP:
W: 28
H: 25,30,36,42,47
D: 18

Right Hinge Door
Fixed Shelves

14" DEEP:
W: 25
H: 25,30,36,42,47
D: 14

18" DEEP:
W: 28
H: 25,30,36,42,47
D: 18

Left Hinge Door
Fixed Shelves

14" DEEP:
W: 25
H: 30,36,42,47
D: 14

18" DEEP:
W: 28
H: 30,36,42,47
D: 18

Right Hinge Door
2 Lazy Susans
Fixed Shelf (42H-47H only)

14" DEEP:
W: 25
H: 30,36,42,47
D: 14

18" DEEP:
W: 28
H: 30,36,42,47
D: 18

Left Hinge Door
2 Lazy Susans
Fixed Shelf (42H-47H only)

19211

19212

19213

19214

25H

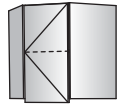
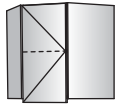

30H
36H

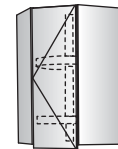
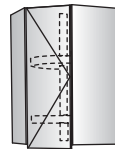
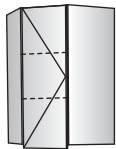

42H
47H

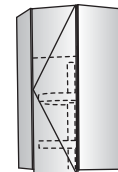
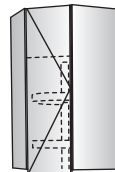
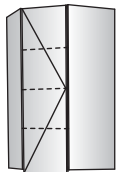

Doors extend 1" below cabinet to allow opening without pull hardware.
Height (H) denotes cabinet box height.

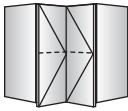
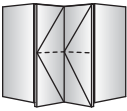
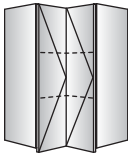
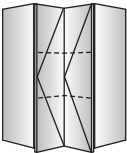
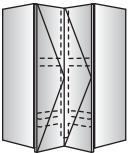
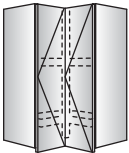
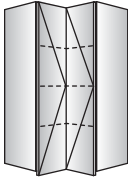
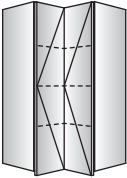
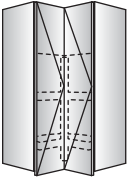
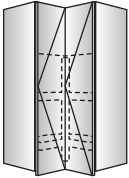
Corner – L-Shaped				
	14" DEEP: W: 26 H: 25,30,36,42,47 D: 14 18" DEEP: W: 29 H: 25,30,36,42,47 D: 18 Right Hinge Folding Door Fixed Shelves	14" DEEP: W: 26 H: 25,30,36,42,47 D: 14 18" DEEP: W: 29 H: 25,30,36,42,47 D: 18 Left Hinge Folding Door Fixed Shelves	14" DEEP: W: 26 H: 30,36,42,47 D: 14 18" DEEP: W: 29 H: 30,36,42,47 D: 18 Right Hinge Folding Door 2 Lazy Susans Fixed Shelf (42H-47H only)	14" DEEP: W: 26 H: 30,36,42,47 D: 14 18" DEEP: W: 29 H: 30,36,42,47 D: 18 Left Hinge Folding Door 2 Lazy Susans Fixed Shelf (42H-47H only)
	19215	19216	19217	19218
25H				
30H 36H				
42H 47H				

VALANCE – STREAMLINED







Cubicle

Doors extend 1" below cabinet to allow opening without pull hardware.
Height (H) denotes cabinet box height.

Cubicle		Cubicle		Cubicle		Cubicle	
<p>Compt. Widths 18W = 7 7/8" 21W = 9 3/8" 24W = 10 7/8"</p>	<p>W: 18,21,24 H: 25,30,36,42,47 D: 14,18</p> <p>Right Hinge Door 3/4" Adjustable Cubicle Shelves Compartment Spacing 3"H min.</p>	<p>W: 18,21,24 H: 25,30,36,42,47 D: 14,18</p> <p>Left Hinge Door 3/4" Adjustable Cubicle Shelves Compartment Spacing 3"H min.</p>	<p>Compt. Widths 30W = 9" 36W = 11" 42W = 13" 48W = 15"</p>	<p>W: 30,36,42,48 H: 25,30,36,42,47 D: 14,18</p> <p>Doors 3/4" Adjustable Cubicle Shelves Compartment Spacing 3"H min.</p>	<p>Compt. Widths 36W = 8" 42W = 9 1/2" 48W = 11"</p>	<p>W: 36,42,48 H: 25,30,36,42,47 D: 14,18</p> <p>Doors 3/4" Adjustable Cubicle Shelves Compartment Spacing 3"H min.</p>	
19222		19223		19227		19240	
<p>25H 30H 6 Compts.</p>			<p>25H 30H 9 Compts.</p>		<p>25H 30H 12 Compts.</p>		
<p>36H 8 Compts.</p>			<p>36H 12 Compts.</p>		<p>36H 16 Compts.</p>		
<p>42H 47H 10 Compts.</p>			<p>42H 47H 15 Compts.</p>		<p>42H 47H 20 Compts.</p>		

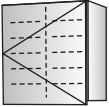
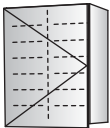
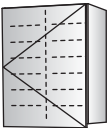
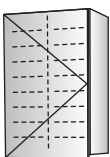
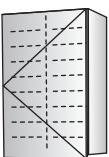
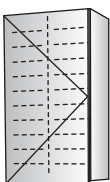
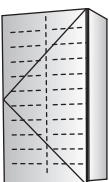
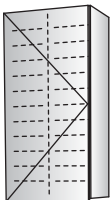
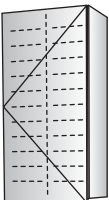
Pass-Thru Mail Cubicle

Doors extend 1" below cabinet to allow opening without pull hardware.
Height (H) denotes cabinet box height.

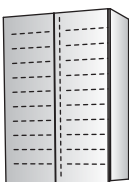
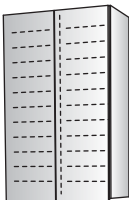







Pass-Thru Mail Cubile			
Doors, One Face			
Compt. Widths 21W = 9 ³ / ₈ " 24W = 10 ⁷ / ₈ "	W: 21,24 H: 25,30,36,42,47 D: 14,18 Right Hinge Door, One Face 3/4" Adjustable, Equally Spaced Cubicle Shelves Compartment Spacing 3"H min.	W: 21,24 H: 25,30,36,42,47 D: 14,18 Left Hinge Door, One Face 3/4" Adjustable, Equally Spaced Cubicle Shelves Compartment Spacing 3"H min.	Compt. Widths 30W = 13 ⁷ / ₈ " 36W = 16 ⁷ / ₈ "
	W: 30,36 H: 25,30,36,42,47 D: 14,18 Doors, One Face 3/4" Adjustable, Equally Spaced Cubicle Shelves Compartment Spacing 3"H min.		
19257		19258	
25H 12 Compts.			25H 12 Compts.
30H 14 Compts.			30H 14 Compts.
36H 18 Compts.			36H 18 Compts.
42H 22 Compts.			42H 22 Compts.
47H 24 Compts.			47H 24 Compts.
			19259
			
			
			
			
			

VALANCE – STREAMLINED





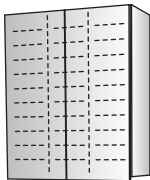
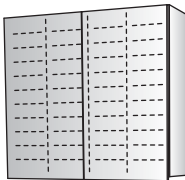
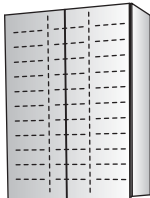



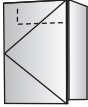
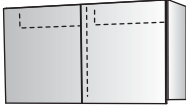
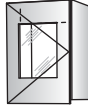
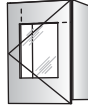
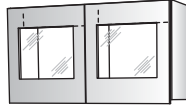

Pass-Thru Mail Cubicle

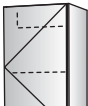
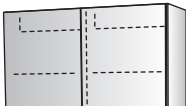
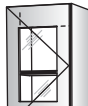
Doors extend 1" below cabinet to allow opening without pull hardware.
Height (H) denotes cabinet box height.

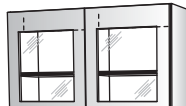
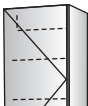
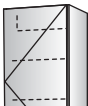
Pass-Thru Mail Cubile	
Doors, One Face	
<p>Compt. Widths 30W = 9" 36W = 11" 42W = 13" 48W = 15"</p>	<p>W: 30,36,42,48 H: 25,30,36,42,47 D: 14,18</p> <p>Doors, One Face 3/4" Adjustable, Equally Spaced Cubicle Shelves Compartment Spacing 3"H min.</p>
<p>19260</p>	<p>19261</p>
<p>25H 18 Compts.</p> 	<p>25H 24 Compts.</p> 
<p>30H 21 Compts.</p> 	<p>30H 28 Compts.</p> 
<p>36H 27 Compts.</p> 	<p>36H 36 Compts.</p> 
<p>42H 33 Compts.</p> 	<p>42H 44 Compts.</p> 
<p>47H 36 Compts.</p> 	<p>47H 48 Compts.</p> 

Doors extend 1" below cabinet to allow opening without pull hardware.
Height (H) denotes cabinet box height.

Pass-Thru						
Doors, One Face			Display Doors, One Face			
W:	W:	W:	W:	W:	W:	W:
H:	H:	H:	H:	H:	H:	H:
D:	D:	D:	D:	D:	D:	D:
Right Hinge Door, One Face Adjustable Shelves (30H-36H only)		Left Hinge Door, One Face Adjustable Shelves (30H-36H only)	Doors, One Face Center Divider Adjustable Shelves (30H-36H only)	Right Hinge Display Door, One Face Adjustable Shelves (30H-36H only)	Left Hinge Display Door, One Face Adjustable Shelves (30H-36H only)	Display Doors, One Face Center Divider Adjustable Shelves (30H-36H only)
19271	19272	19274	19280	19281	19283	
25H						
30H						
36H						

VALANCE – STREAMLINED



Pass-Thru

Doors extend 1" below cabinet to allow opening without pull hardware.
Height (H) denotes cabinet box height.

Pass-Thru					
Doors, Two Faces		Display Doors, Two Faces			
<p>W: 12,15,18,21,24 H: 25,30,36 D: 14,18</p> <p>Right Hinge Door, Front Face Left Hinge Door, Back Face Adjustable Shelves (30H-36H only)</p>		<p>W: 30,36,42,48 H: 25,30,36 D: 14,18</p> <p>Doors, Two Faces Center Divider Adjustable Shelves (30H-36H only)</p>			
<p>W: 15,18,21,24 H: 25,30,36 D: 14,18</p> <p>Right Hinge Display Door, Front Face Left Hinge Display Door, Back Face Adjustable Shelves (30H-36H only)</p>		<p>W: 30,36,42,48 H: 25,30,36 D: 14,18</p> <p>Display Doors, Two Faces Center Divider Adjustable Shelves (30H-36H only)</p>			
19275		19277	19278		19282
25H					
30H					
36H					

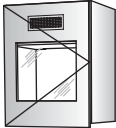
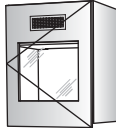
Media Integration	
<p>W: 21,24 H: 30 D: 18</p> <p>Right Hinge Display Door Black Vent Grille Adjustable Shelves with Wire Management Slot</p>	<p>W: 21,24 H: 30 D: 18</p> <p>Left Hinge Display Door Black Vent Grille Adjustable Shelves with Wire Management Slot</p>
19500	19501
30H	
	

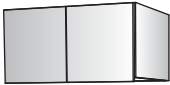
Specialty	
Above Refrigerator	
<p>W: 30,33,36,39 H: 11,15,17 D: 14,18,24</p> <p>Doors Sizes Appropriate for Use Above Refrigerator Refer to Sizing Guidelines at right and Mounting Requirements on next page</p>	
19103	
<p>11H 15H 17H</p>	

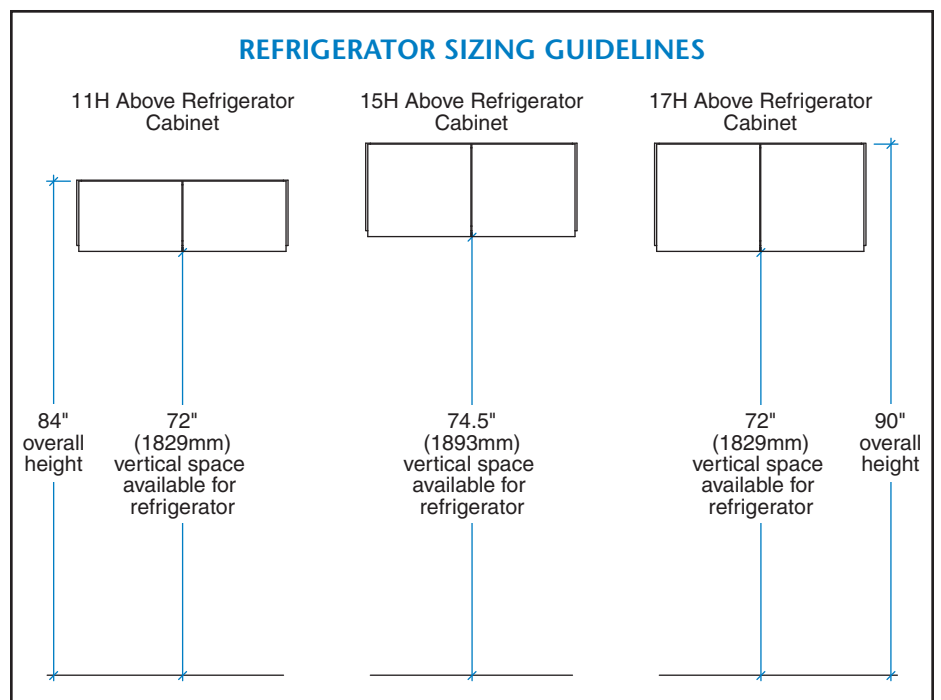

VALANCE – STREAMLINED

Specialty

Doors extend 1" below cabinet to allow opening without pull hardware.
Height (H) denotes cabinet box height.



14D/18D Above Refrigerator Cabinet mounting is the same as that of standard wall cabinets.

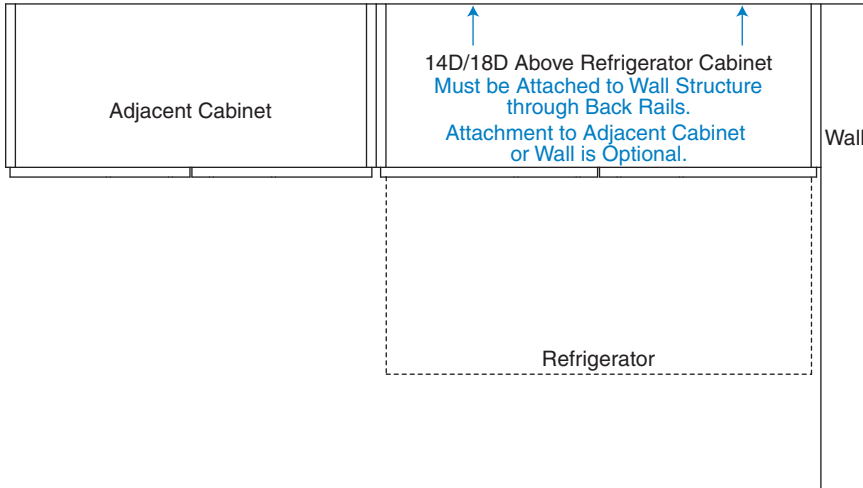

MOUNTING REQUIREMENTS FOR 14D/18D ABOVE REFRIGERATOR CABINETS

If located against wall, 24D Above Refrigerator Cabinet must be attached through end panels to adjacent wall and adjacent cabinet.

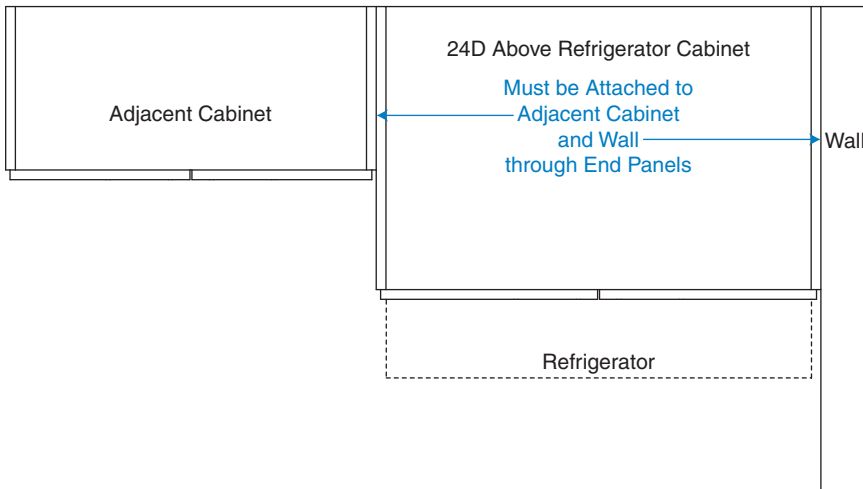



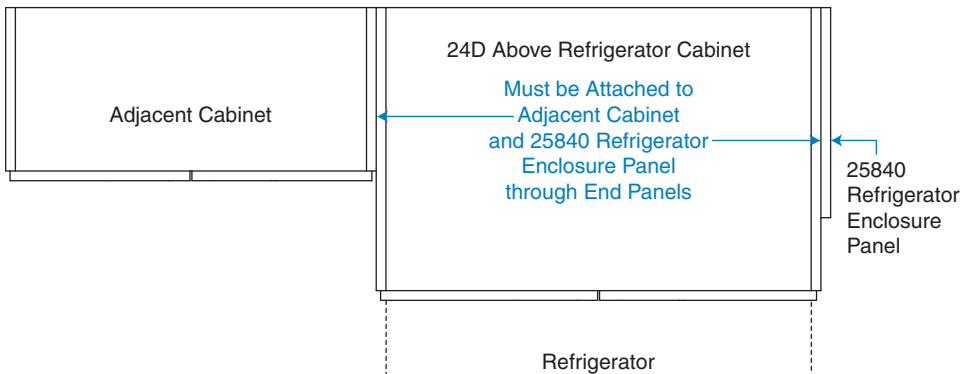

MOUNTING REQUIREMENTS FOR 24D ABOVE REFRIGERATOR CABINETS

If open ended, 24D Above Refrigerator Cabinet must be attached to adjacent cabinet and 25840 Refrigerator Enclosure Panel adjacent to cabinet end.

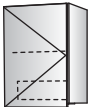
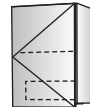

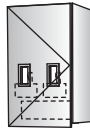
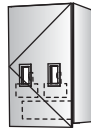
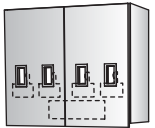
Doors extend 1" below cabinet to allow opening without pull hardware.
Height (H) denotes cabinet box height.

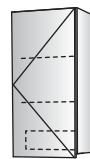
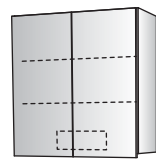
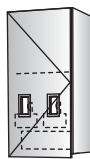
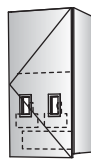
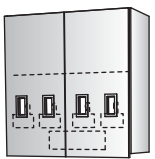
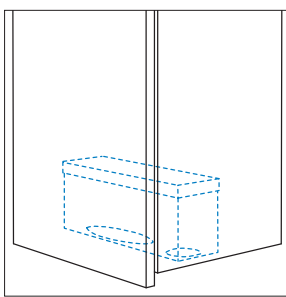
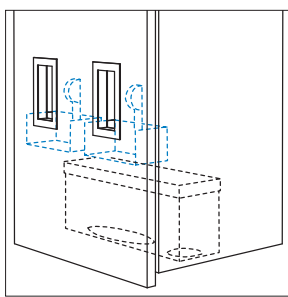
Specialty			Specialty		
Dispensing – Towel/Cup			Dispensing – Towel/Cup/Glove/Tissue		
W: 18,21,24 H: 25,30,36 D: 14,18 Right Hinge Door Towel/Cup Dispenser Adjustable Shelves	W: 18,21,24 H: 25,30,36 D: 14,18 Left Hinge Door Towel/Cup Dispenser Adjustable Shelves	W: 27,30,33,36,39, 42,45,48 H: 25,30,36 D: 14,18 Doors Towel/Cup Dispenser Adjustable Shelves	W: 18,21,24 H: 25,30,36 D: 14,18 Right Hinge Door Towel/Cup and Glove/Tissue Dispensers Adjustable Shelf (36H only)	W: 18,21,24 H: 25,30,36 D: 14,18 Left Hinge Door Towel/Cup and Glove/Tissue Dispensers Adjustable Shelf (36H only)	W: 36,39,42,45,48 H: 25,30,36 D: 14,18 Doors Towel/Cup and Glove/Tissue Dispensers Adjustable Shelf (36H only)
19122	19123	19126	19124	19125	19127
25H 			25H 30H 		
30H 36H 			36H 		
 <p>TOWEL/CUP DISPENSER Bottom-access dispensing of paper towels and 5 oz. cups.</p>			 <p>GLOVE/TISSUE DISPENSER Face-of-door access for gloves or tissues.</p>		

VALANCE – STREAMLINED



Specialty

Doors extend 1" below cabinet to allow opening without pull hardware.
Height (H) denotes cabinet box height.

The narcotics locker and cabinet door locks are keyed differently and require separate keys.
Both doors to be keyed differently from all other cabinets.

Specialty

Narcotics Locker

W: 18,21,24
H: 25,30,36
D: 14,18

Locked Right Hinge Door
Locked Steel Narcotics Locker
Fixed Shelf
Adjustable Shelf (36H only)

W: 18,21,24
H: 25,30,36
D: 14,18

Locked Left Hinge Door
Locked Steel Narcotics Locker
Fixed Shelf
Adjustable Shelf (36H only)

W: 30,36,39,42,45,48
H: 25,30,36
D: 14,18

Locked Doors
Locked Steel Narcotics Locker
Fixed Shelf
Adjustable Shelf (36H only)

19290

19291

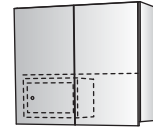
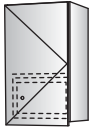

19294

25H
30H

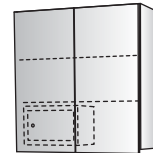
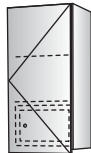
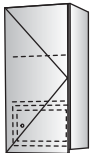

36H

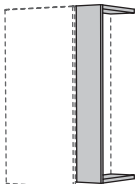
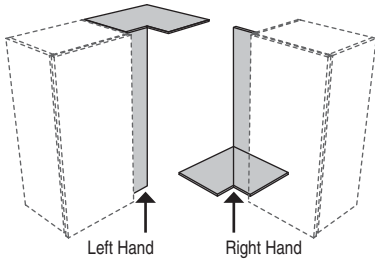

Soffit Trim	Vertical Scribe	Front Filler	Corner Filler/Closure
<p>W: 96 H: 00 D: 03</p> <p>Field Trim to Fit Actual Thickness=3/4" Actual Depth=3" Edgebanding: One Long Edge in Casebody Trim Color and 0.5mm Thickness</p>	<p>W: 00 H: 18,25,30,36,42,47 D: 14,18</p> <p>Field Trim to Fit Actual Thickness=3/4" Actual Depth=3" Edgebanding: One Long Edge in Casebody Trim Color and 0.5mm Thickness</p>	<p>W: 02,03,06,09,12 H: 18,25,30,36,42,47 D: 14,18</p> <p>Field Trim to Fit Includes Top and Bottom Closure Panels Edgebanding: Two Short Edges in Casebody Trim Color and 0.5mm Thickness</p>	<p>W: 02,03,06,09,12 H: 18,25,30,36,42,47 D: 14,18</p> <p>Field Trim to Fit Depths (D) Listed are Depths of Cabinets to which Filler/Closure is Attached Edgebanding (Corner Filler): Two Short Edges in Casebody Trim Color and 0.5mm Thickness Edgebanding (Closure): None</p>
15801	15802	15803	15805
			

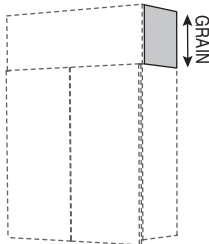
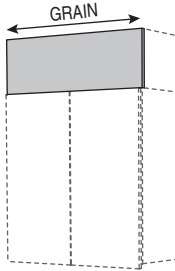
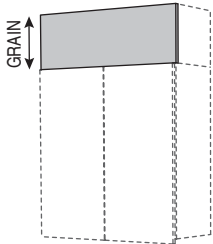
Valance Rail	End Soffit Closure	Horizontal Grain Soffit Fascia	Vertical Grain Soffit Fascia
<p>W: 48,96 H: 03 D: 00</p> <p>Field Trim to Fit Edgebanding: One Long Edge in Casebody Trim Color and Thickness</p>	<p>W: 00 H: 12,18,24 D: 14,18</p> <p>Field Trim to Fit Edgebanding: All Edges in Casebody Trim Color and 0.5mm Thickness</p>	<p>W: 36,48,60,72,84,96 H: 12,18,24 D: 00</p> <p>Field Trim to Fit Edgebanding: One Long and Two Short Edges in Casebody Trim Color and 0.5mm Thickness</p>	<p>W: 12,15,18,21,24,27,30,33,36,39,42,45,48 H: 12,18,24 D: 00</p> <p>Field Trim to Fit Edgebanding: One Short and Two Long Edges in Casebody Trim Color and 0.5mm Thickness</p>
15812	15820	15822	15823
			
	Shown with 15822/15823 Soffit Fascia	Shown with 15820 End Soffit Closure	Shown with 15820 End Soffit Closure

VALANCE – STREAMLINED

Installation Accessories



Soffit Extension

W: 12,15,18,21,24,27,30,33,36,39,42,45,48

H: 6"-34" in 1" increments

D: 14,18

Edgebanding (Box): All Edges in Casebody
Trim Color and Thickness

Edgebanding (Soffit Panel): All Edges in
Door/Drawer Trim Color and Thickness

15824

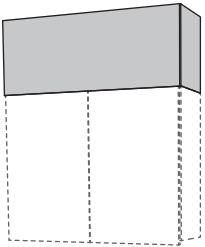

STREAMLINED VALANCE

Stevens Advantage streamlined valance units are designed the same as wall cabinets, except the doors extend 1" below the cabinet box to allow opening without the need for pull hardware.

