

Table of Contents

SLOPE WALL



Shelf 3-4



Bookshelf 5



Display 6-7



Expanded Metal Door 8



Corner 9



Cubicle 10-11



Forms 11



Mail Cubicle 12



Folder 13



Media Integration 14



Specialty 14-16

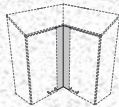

Installation Accessories 17









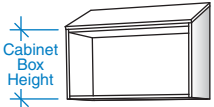

Design Details 18

SLOPE WALL

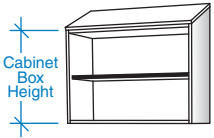
Commercial Cabinetry and Millwork

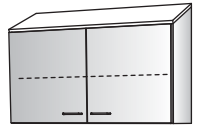
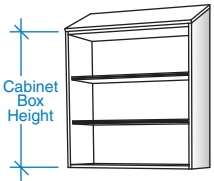

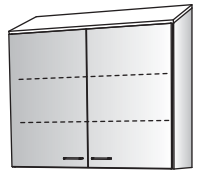
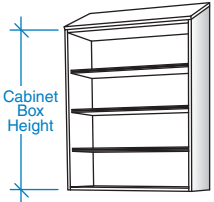
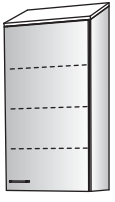
Slope top units require 16816 slope top cover panel for field installation.
Height (H) denotes cabinet box height.

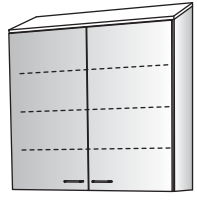
| Shelf | | | | |
|--|--|--|---|---|
| | <p>W: 12,15,18,21,24,27,30,33,36,39,42,45,48</p> <p>H: 12,16,18,25,30,36,42,47</p> <p>D: 14,18</p> <p>Adjustable Shelves (25H-47H only)</p> | <p>12",16",18" HIGH:</p> <p>W: 12,15,18</p> <p>H: 12,16,18</p> <p>D: 14,18</p> <p>25",30",36",42",47" HIGH:</p> <p>W: 12,15,18,21,24</p> <p>H: 25,30,36,42,47</p> <p>D: 14,18</p> <p>Right Hinge Door</p> <p>Adjustable Shelves (25H-47H only)</p> | <p>12",16",18" HIGH:</p> <p>W: 12,15,18</p> <p>H: 12,16,18</p> <p>D: 14,18</p> <p>25",30",36",42",47" HIGH:</p> <p>W: 12,15,18,21,24</p> <p>H: 25,30,36,42,47</p> <p>D: 14,18</p> <p>Left Hinge Door</p> <p>Adjustable Shelves (25H-47H only)</p> | <p>12",16",18" HIGH:</p> <p>W: 24,27,30,33,36</p> <p>H: 12,16,18</p> <p>D: 14,18</p> <p>25",30",36",42",47" HIGH:</p> <p>W: 24,27,30,33,36,39,42,45,48</p> <p>H: 25,30,36,42,47</p> <p>D: 14,18</p> <p>Doors</p> <p>Adjustable Shelves (25H-47H only)</p> |
| | 16101 | 16120 | 16121 | 16129 |
| 12H 16H 18H |  |  |  |  |
| 25H |  |  |  |  |
| 30H 36H |  |  |  |  |
| 42H 47H |  |  |  |  |

SLOPE WALL





Shelf

Slope top units require 16816 slope top cover panel for field installation.
Height (H) denotes cabinet box height.

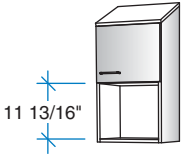

| Shelf | | Shelf | | Shelf | |
|---|--|--|--|---|--|
| W: 36,39,42,45,48 H: 12,16,18,25,30,36,42,47 D: 14,18 Center Divider Adjustable Shelves (25H-47H only) | | W: 36,39,42,45,48 H: 25,30,36,42,47 D: 14,18 Doors Center Divider Adjustable Shelves | | W: 36,39,42,45,48 H: 16,18,25,30,36,42,47 D: 14,18 Sliding Doors Center Divider Adjustable Shelves (25H-47H only) | |
| 16138 | | 16181 | | 16150 | |
| 12H 16H 18H | | | | 16H 18H | |
| 25H | | | | 25H | |
| 30H 36H | | | | 30H 36H | |
| 42H 47H | | | | 42H 47H | |

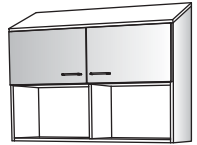
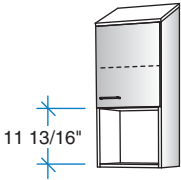
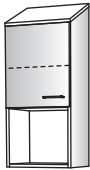
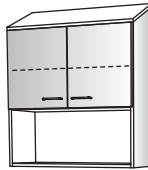
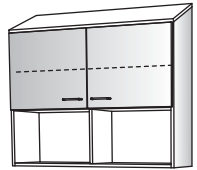
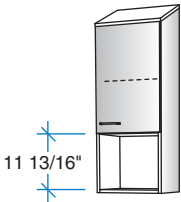
Slope top units require 16816 slope top cover panel for field installation.
Height (H) denotes cabinet box height.

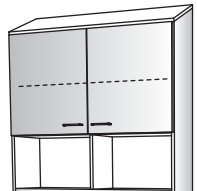
| Bookshelf | | | | |
|--------------------|---|--|--|--|
| | <p>W: 12,15,18,21,24 H: 30,36,42,47 D: 14,18</p> <p>Right Hinge Door Open Compartment (11¹³/₁₆"H) Adjustable Shelf in Upper Compartment (36H-47H only)</p> | <p>W: 12,15,18,21,24 H: 30,36,42,47 D: 14,18</p> <p>Left Hinge Door Open Compartment (11¹³/₁₆"H) Adjustable Shelf in Upper Compartment (36H-47H only)</p> | <p>W: 30,33,36 H: 30,36,42,47 D: 14,18</p> <p>Doors Open Compartment (11¹³/₁₆"H) Adjustable Shelf in Upper Compartment (36H-47H only)</p> | <p>W: 39,42,45,48 H: 30,36,42,47 D: 14,18</p> <p>Doors Center Divider in Open Compartment Open Compartment (11¹³/₁₆"H) Adjustable Shelf in Upper Compartment (36H-47H only)</p> |
| | 16184 | 16185 | 16186 | 16187 |
| 30H |  |  |  |  |
| 36H |  |  |  |  |
| 42H 47H |  |  |  |  |

SLOPE WALL

Display







Slope top units require 16816 slope top cover panel for field installation.
Height (H) denotes cabinet box height.

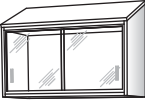
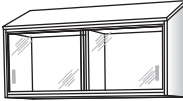

| Display | | | | |
|------------|--|---|---|--|
| | <p>W: 15,18,21,24 H: 25,30,36,42,47 D: 14,18</p> <p>Right Hinge Display Door Adjustable Shelves</p> | <p>W: 15,18,21,24 H: 25,30,36,42,47 D: 14,18</p> <p>Left Hinge Display Door Adjustable Shelves</p> | <p>W: 30,36 H: 25,30,36,42,47 D: 14,18</p> <p>Display Doors Adjustable Shelves</p> | <p>W: 30,36,42,48 H: 25,30,36,42,47 D: 14,18</p> <p>Display Doors Center Divider Adjustable Shelves</p> |
| | 16130 | 16131 | 16136 | 16182 |
| 25H | | | | |
| 30H 36H | | | | |
| 42H 47H | | | | |

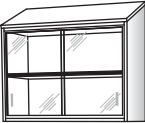
Display

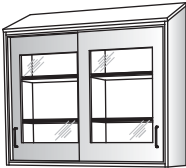
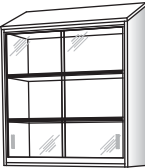
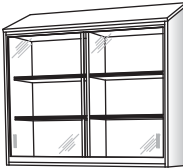
Slope top units require 16816 slope top cover panel for field installation.
Height (H) denotes cabinet box height.

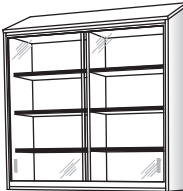
| | Display | | |
|--------------------------|--|---|---|
| | <p>W: 30,36,42,48 H: 25,30,36,42,47 D: 14,18</p> <p>Sliding Display Doors Center Divider Adjustable Shelves</p> | <p>W: 30,33,36 H: 16,18,25,30,36,42,47 D: 14,18</p> <p>Sliding Glass Doors Adjustable Shelves (25H-47H only)</p> | <p>W: 39,42,45,48 H: 16,18,25,30,36,42,47 D: 14,18</p> <p>Sliding Glass Doors Center Divider Adjustable Shelves (25H-47H only)</p> |
| | 16154 | 16156 | 16158 |
| 16H 18H | |  |  |
| 25H |  |  |  |
| 30H 36H |  |  |  |
| 42H 47H |  |  |  |

SLOPE WALL

Expanded Metal Door

Slope top units require 16816 slope top cover panel for field installation.
Height (H) denotes cabinet box height.



Expanded Metal Door

W: 15,18,21,24
H: 25,30,36,42,47
D: 14,18

Right Hinge Framed Expanded Metal Door
Adjustable Shelves
Expanded Metal Available in Black, White, Grey (color linked to accent color option)

W: 15,18,21,24
H: 25,30,36,42,47
D: 14,18

Left Hinge Framed Expanded Metal Door
Adjustable Shelves
Expanded Metal Available in Black, White, Grey (color linked to accent color option)

W: 30,36
H: 25,30,36,42,47
D: 14,18

Framed Expanded Metal Doors
Adjustable Shelves
Expanded Metal Available in Black, White, Grey (color linked to accent color option)

W: 30,36,42,48
H: 25,30,36,42,47
D: 14,18

Framed Expanded Metal Doors
Center Divider
Adjustable Shelves
Expanded Metal Available in Black, White, Grey (color linked to accent color option)

16106

16107

16108

16109

25H

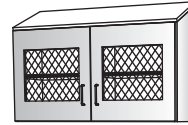



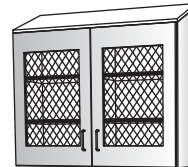



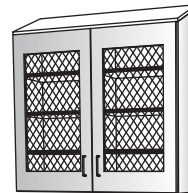
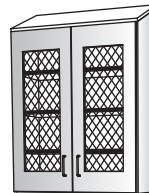
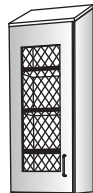

30H
36H

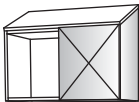
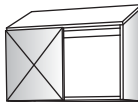
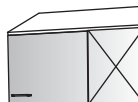

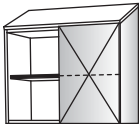
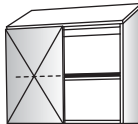
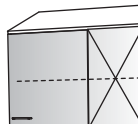
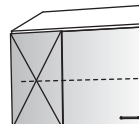
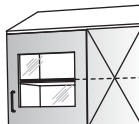
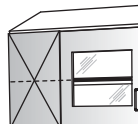
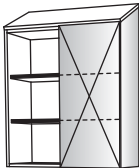
42H
47H

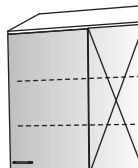
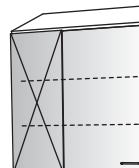
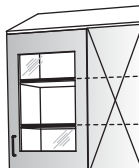
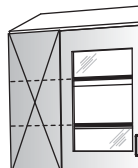
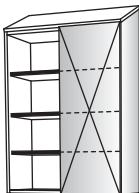

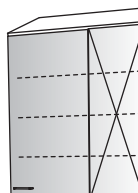
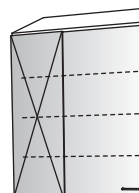
Slope top units require 16816 slope top cover panel for field installation.
Height (H) denotes cabinet box height.

| | Corner – Blind | | | | | |
|--------------------|---|--|---|--|--|---|
| | <p>14" DEEP: W: 33,36 H: 16,18,25,30,36,42,47 D: 14</p> <p>18" DEEP: W: 36,39 H: 16,18,25,30,36,42,47 D: 18</p> <p>Left Hand Open Adjustable Shelves (25H-47H only)</p> | <p>14" DEEP: W: 33,36 H: 16,18,25,30,36,42,47 D: 14</p> <p>18" DEEP: W: 36,39 H: 16,18,25,30,36,42,47 D: 18</p> <p>Right Hand Open Adjustable Shelves (25H-47H only)</p> | <p>14" DEEP: W: 33,36 H: 16,18,25,30,36,42,47 D: 14</p> <p>18" DEEP: W: 36,39 H: 16,18,25,30,36,42,47 D: 18</p> <p>Right Hinge Door Adjustable Shelves (25H-47H only)</p> | <p>14" DEEP: W: 33,36 H: 16,18,25,30,36,42,47 D: 14</p> <p>18" DEEP: W: 36,39 H: 16,18,25,30,36,42,47 D: 18</p> <p>Left Hinge Door Adjustable Shelves (25H-47H only)</p> | <p>14" DEEP: W: 33,36 H: 25,30,36,42,47 D: 14</p> <p>18" DEEP: W: 36,39 H: 25,30,36,42,47 D: 18</p> <p>Right Hinge Display Door Adjustable Shelves</p> | <p>14" DEEP: W: 33,36 H: 25,30,36,42,47 D: 14</p> <p>18" DEEP: W: 36,39 H: 25,30,36,42,47 D: 18</p> <p>Left Hinge Display Door Adjustable Shelves</p> |
| | 16198 | 16199 | 16200 | 16201 | 16202 | 16203 |
| 16H 18H |  |  |  |  | | |
| 25H |  |  |  |  |  |  |
| 30H 36H |  |  |  |  |  |  |
| 42H 47H |  |  |  |  |  |  |

SLOPE WALL

Cubicle



Slope top units require 16816 slope top cover panel for field installation.
Height (H) denotes cabinet box height.



| Cubicle | | | | | | |
|---|--|--|---|---|---|--|
| Compt. Widths 18W = 7 7/8" 21W = 9 3/8" 24W = 10 7/8" | W: 18,21,24 H: 25,30,36,42,47 D: 14,18 3/4" Adjustable Cubicle Shelves Compartment Spacing 3"H min. | W: 18,21,24 H: 25,30,36,42,47 D: 14,18 Right Hinge Door 3/4" Adjustable Cubicle Shelves Compartment Spacing 3"H min. | W: 18,21,24 H: 25,30,36,42,47 D: 14,18 Left Hinge Door 3/4" Adjustable Cubicle Shelves Compartment Spacing 3"H min. | Compt. Widths 30W = 9" 36W = 11" 42W = 13" 48W = 15" | W: 30,36,42,48 H: 25,30,36,42,47 D: 14,18 3/4" Adjustable Cubicle Shelves Compartment Spacing 3"H min. | W: 30,36,42,48 H: 25,30,36,42,47 D: 14,18 Doors 3/4" Adjustable Cubicle Shelves Compartment Spacing 3"H min. |
| | 16220 | 16222 | 16223 | | 16226 | 16227 |
| | 25H 30H 6 Compts. | | | | | 25H 30H 9 Compts. |
| 36H 8 Compts. | | | | 36H 12 Compts. | | |
| 42H 47H 10 Compts. | | | | 42H 47H 15 Compts. | | |

Cubicle / Forms

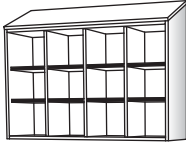
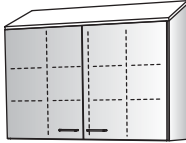
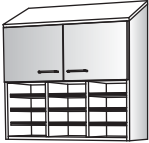
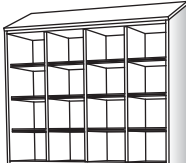
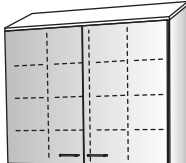
Slope top units require 16816 slope top cover panel for field installation.
Height (H) denotes cabinet box height.

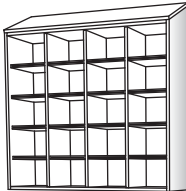
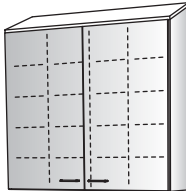
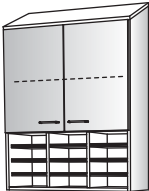
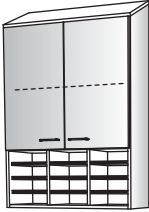



| Cubicle | | Forms | | |
|--|--|---|---|---|
| Compt. Widths 36W = 8" 42W = 9½" 48W = 11" | W: 36,42,48 H: 25,30,36,42,47 D: 14,18 ¾" Adjustable Cubicle Shelves Compartment Spacing 3"H min. | W: 36,42,48 H: 25,30,36,42,47 D: 14,18 Doors ¾" Adjustable Cubicle Shelves Compartment Spacing 3"H min. | Compt. Widths 30W = 9" 36W = 11" 42W = 13" 48W = 15" | W: 30,36,42,48 H: 30,36,42,47 D: 14,18 Upper Doors Adjustable Shelf in Upper Compartment (36H-47H only) ¾" Adjustable, Equally Spaced Cubicle Shelves Compartment Spacing 3"H min. |
| | 16239 | 16240 | | 16256 |
| 25H 30H 12 Compts. |  |  | 30H 12 Compts. |  |
| 36H 16 Compts. |  |  | 36H 12 Compts. |  |
| 42H 47H 20 Compts. |  |  | 42H 12 Compts. |  |
| | | | 47H 12 Compts. |  |

SLOPE WALL

Mail Cubicle

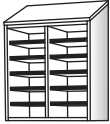
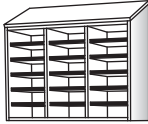
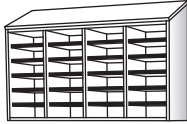
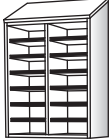
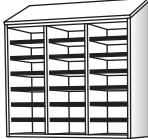
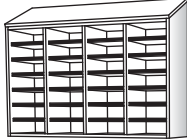
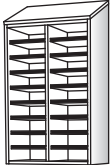
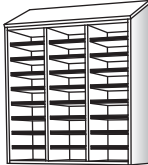
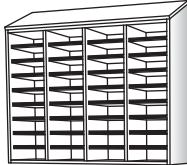
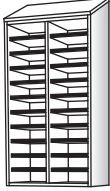
Slope top units require 16816 slope top cover panel for field installation.
Height (H) denotes cabinet box height.

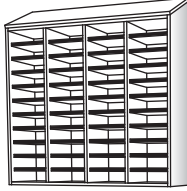

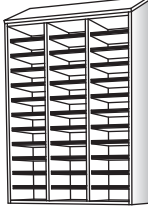
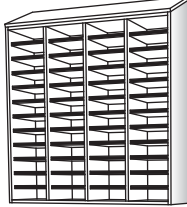

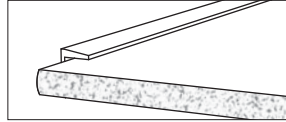

| Mail Cubicle | | Open, One Face | | Open, One Face | |
|--|--|--|--|--|--|
| <p>Compt. Widths 21W = 9 3/8" 24W = 10 7/8" 30W = 13 7/8" 36W = 16 7/8"</p> | <p>W: 21,24,30,36 H: 25,30,36,42,47 D: 14,18</p> <p>Open, One Face 3/4" Adjustable, Equally Spaced Cubicle Shelves Compartment Spacing 3"H min.</p> | <p>Compt. Widths 30W = 9" 36W = 11" 42W = 13" 48W = 15"</p> | <p>W: 30,36,42,48 H: 25,30,36,42,47 D: 14,18</p> <p>Open, One Face 3/4" Adjustable, Equally Spaced Cubicle Shelves Compartment Spacing 3"H min.</p> | <p>Compt. Widths 42W = 9 1/2" 48W = 11"</p> | <p>W: 42,48 H: 25,30,36,42,47 D: 14,18</p> <p>Open, One Face 3/4" Adjustable, Equally Spaced Cubicle Shelves Compartment Spacing 3"H min.</p> |
| 16250 | | 16251 | | 16252 | |
| <p>25H 12 Compts.</p>  | <p>25H 18 Compts.</p>  | <p>25H 24 Compts.</p>  | | | |
| <p>30H 14 Compts.</p>  | <p>30H 21 Compts.</p>  | <p>30H 28 Compts.</p>  | | | |
| <p>36H 18 Compts.</p>  | <p>36H 27 Compts.</p>  | <p>36H 36 Compts.</p>  | | | |
| <p>42H 22 Compts.</p>  | <p>42H 33 Compts.</p>  | <p>42H 44 Compts.</p>  | | | |
| <p>47H 24 Compts.</p>  | <p>47H 36 Compts.</p>  | <p>47H 48 Compts.</p>  | | | |

Folder

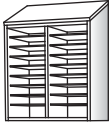
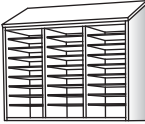
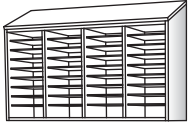
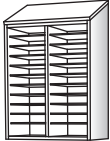
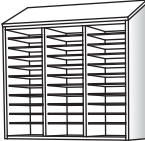
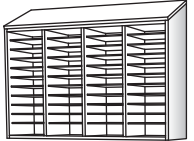
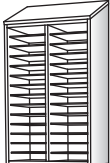
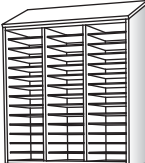
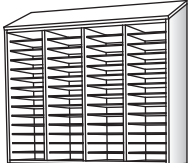
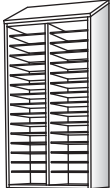

1/4"-thick folder shelves are held securely with translucent, low profile shelf supports. All edges unfinished. Front edge unfinished and shaped.

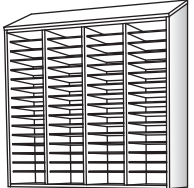
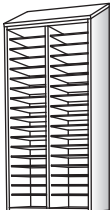
Slope top units require 16816 slope top cover panel for field installation. Height (H) denotes cabinet box height.

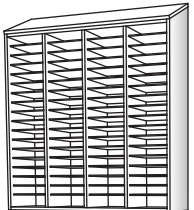
| Folder | | Folder | | Folder | |
|--------------------------|--|--------------------------|--|--------------------------|--|
| | <p>W: 21,24,30,36 H: 25,30,36,42,47 D: 14,18</p> <p>1/4" Folder Shelves, Adjustable and Removable on 1 1/4" Centers Compartments 2 1/4"H min.</p> | | <p>W: 30,36,42,48 H: 25,30,36,42,47 D: 14,18</p> <p>1/4" Folder Shelves, Adjustable and Removable on 1 1/4" Centers Compartments 2 1/4"H min.</p> | | <p>W: 42,48 H: 25,30,36,42,47 D: 14,18</p> <p>1/4" Folder Shelves, Adjustable and Removable on 1 1/4" Centers Compartments 2 1/4"H min.</p> |
| 16241 | | 16242 | | 16243 | |
| 25H 18 Compts. |  | 25H 27 Compts. |  | 25H 36 Compts. |  |
| 30H 22 Compts. |  | 30H 33 Compts. |  | 30H 44 Compts. |  |
| 36H 28 Compts. |  | 36H 42 Compts. |  | 36H 56 Compts. |  |
| 42H 32 Compts. |  | 42H 48 Compts. |  | 42H 64 Compts. |  |
| 47H 36 Compts. |  | 47H 54 Compts. |  | 47H 72 Compts. |  |

SLOPE WALL

Media Integration / Specialty

Slope top units require 16816 slope top cover panel for field installation.
Height (H) denotes cabinet box height.



Media Integration

W: 21,24
H: 30
D: 18

Right Hinge Display Door
Black Vent Grille
Adjustable Shelves with Wire Management Slot

W: 21,24
H: 30
D: 18

Left Hinge Display Door
Black Vent Grille
Adjustable Shelves with Wire Management Slot

16500

16501

30H



Specialty

Microwave

W: 27,30,33,36
H: 30,36
D: 14,18

20"-Deep Attachable Microwave Shelf
Accommodates Typical 1 cu.ft. - 2 cu.ft.
Microwave







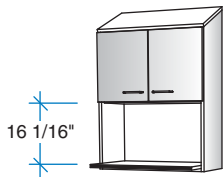

16149

30H

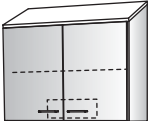
36H

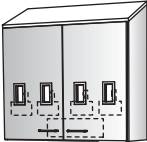

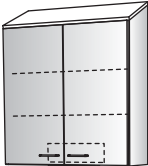
Slope top units require 16816 slope top cover panel for field installation.
Height (H) denotes cabinet box height.

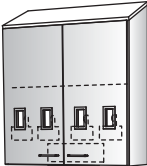
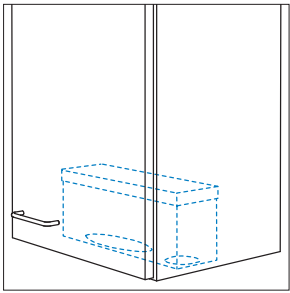
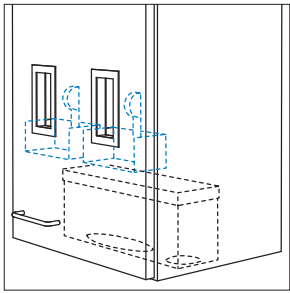
| Specialty | | | Specialty | | |
|--|---|---|---|--|--|
| Dispensing – Towel/Cup | | | Dispensing – Towel/Cup/Glove/Tissue | | |
| W: 18,21,24 H: 25,30,36 D: 14,18 | W: 18,21,24 H: 25,30,36 D: 14,18 | W: 27,30,33,36,39, 42,45,48 H: 25,30,36 D: 14,18 | W: 18,21,24 H: 25,30,36 D: 14,18 | W: 18,21,24 H: 25,30,36 D: 14,18 | W: 36,39,42,45,48 H: 25,30,36 D: 14,18 |
| Right Hinge Door Towel/Cup Dispenser Adjustable Shelves | Left Hinge Door Towel/Cup Dispenser Adjustable Shelves | Doors Towel/Cup Dispenser Adjustable Shelves | Right Hinge Door Towel/Cup and Glove/Tissue Dispensers Adjustable Shelf (36H only) | Left Hinge Door Towel/Cup and Glove/Tissue Dispensers Adjustable Shelf (36H only) | Doors Towel/Cup and Glove/Tissue Dispensers Adjustable Shelf (36H only) |
| 16122 | 16123 | 16126 | 16124 | 16125 | 16127 |
| 25H  |  |  | 25H 30H  |  |  |
| 30H 36H  |  |  | 36H  |  |  |
|  <p>TOWEL/CUP DISPENSER Bottom-access dispensing of paper towels and 5 oz. cups.</p> | | |  <p>GLOVE/TISSUE DISPENSER Face-of-door access for gloves or tissues.</p> | | |

SLOPE WALL



Specialty

Slope top units require 16816 slope top cover panel for field installation.
Height (H) denotes cabinet box height.

The narcotics locker and cabinet door locks are keyed differently and require separate keys.
Both doors to be keyed differently from all other cabinets.

Specialty

Narcotics Locker

W: 18,21,24
H: 25,30,36
D: 14,18

Locked Right Hinge Door
Locked Steel Narcotics Locker
Fixed Shelf
Adjustable Shelf (36H only)

W: 18,21,24
H: 25,30,36
D: 14,18

Locked Left Hinge Door
Locked Steel Narcotics Locker
Fixed Shelf
Adjustable Shelf (36H only)

W: 30,36,39,42,45,48
H: 25,30,36
D: 14,18

Locked Doors
Locked Steel Narcotics Locker
Fixed Shelf
Adjustable Shelf (36H only)

16290

16291

16294

25H
30H

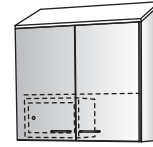

36H

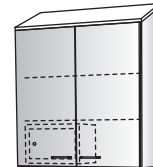

Slope top units require 16816 slope top cover panel for field installation.

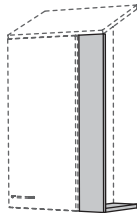
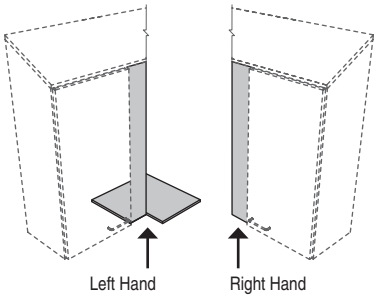
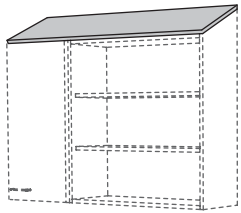
| Vertical Scribe | Front Filler | Corner Filler/Closure | Slope Top Cover Panel |
|--|---|--|---|
| <p>W: 00 H: 12,16,18,25,30,36,42,47 D: 14,18</p> <p>Field Trim to Fit Actual Thickness=3/4" Actual Depth=3" Edgebanding: One Long Edge in Casebody Trim Color and 0.5mm Thickness</p> | <p>W: 02,03,06,09,12 H: 12,16,18,25,30,36,42,47 D: 14,18</p> <p>Field Trim to Fit Includes Bottom Closure Panel Edgebanding: One Short Edge in Casebody Trim Color and 0.5mm Thickness</p> | <p>W: 02,03,06,09,12 H: 12,16,18,25,30,36,42,47 D: 14,18</p> <p>Field Trim to Fit Depths (D) Listed are Depths of Cabinets to which Filler/Closure is Attached Each Filler includes Bottom Closure Panel (shown below with Left Hand Filler) Edgebanding (Corner Filler): Two Short Edges in Casebody Trim Color and 0.5mm Thickness Edgebanding: (Closure): None</p> | <p>W: 36,48,60,72,84,96 H: 00 D: 14,18</p> <p>Shipped in Lengths for Field Trimming Order by Cabinet Depth Based on Standard 25° Rise Edgebanding: One Long and Two Short Edges in Casebody Trim Color and 0.5mm Thickness</p> |
| 15802 | 16803 | 16805 | 16816 |
|  |  |  <p style="text-align: center;">Left Hand Right Hand</p> |  |

Custom Slope Top End Wedge

Field Cut to Desired Size
Provide Height of Rise Desired
Edgebanding: None

16817

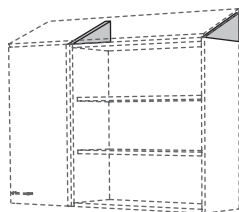

SLOPE WALL

Design Details



SLOPE TOP

Stevens Advantage slope top units are designed with integral slope ends, eliminating the need for on-the-job fabrication of slope structures. Overlay slope cover panels are shipped with length and end edging for final fit and sizing as installation field conditions may require. Stevens Advantage slope design incorporates a full 3/4" thick slope top on a 25° constant rising slope. Slope top options are available on nominal cabinet depths of 14" and 18". Slope tops not recommended for wall-mounted height above 84", due to possible ceiling interferences. 16816 Slope Top Cover Panels must be specified and ordered separately (not included with cabinet units).

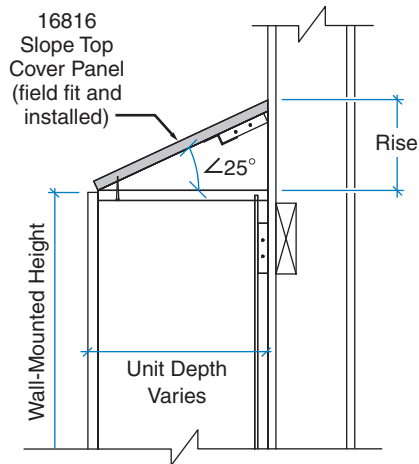

| Nominal Unit Depth | Rise | |
|--------------------|--------|-------|
| | inches | mm |
| 14 | 7 | 177.9 |
| 18 | 8 3/4 | 222.6 |