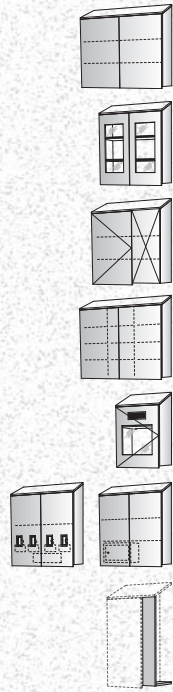

Table of Contents

SLOPE VALANCE – STREAMLINED



Shelf	3
Display	4
Corner	5
Cubicle	6
Media Integration	7
Specialty.....	7-8
Installation Accessories	9
Design Details.....	10

SLOPE VALANCE – STREAMLINED

Commercial Cabinetry and Millwork

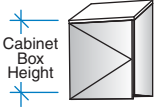
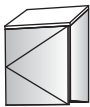
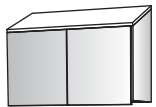
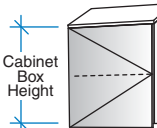
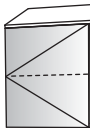
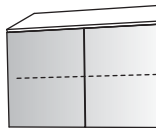
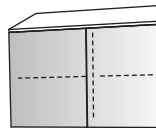
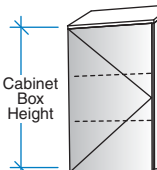
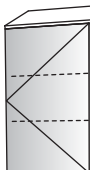
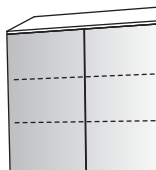
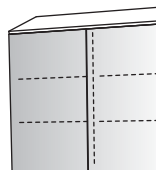
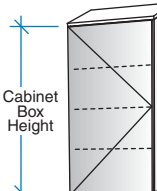
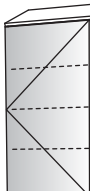
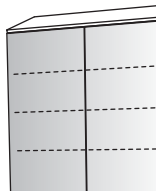
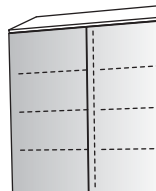

Doors extend 1" below cabinet to allow opening without pull hardware.
Slope top units require 16816 slope top cover panel for field installation.
Height (H) denotes cabinet box height.

Shelf				
	<p>12",16",18" HIGH: W: 12,15,18 H: 12,16,18 D: 14,18</p> <p>25",30",36",42",47" HIGH: W: 12,15,18,21,24 H: 25,30,36,42,47 D: 14,18</p> <p>Right Hinge Door Adjustable Shelves (25H-47H only)</p>	<p>12",16",18" HIGH: W: 12,15,18 H: 12,16,18 D: 14,18</p> <p>25",30",36",42",47" HIGH: W: 12,15,18,21,24 H: 25,30,36,42,47 D: 14,18</p> <p>Left Hinge Door Adjustable Shelves (25H-47H only)</p>	<p>12",16",18" HIGH: W: 24,27,30,33,36 H: 12,16,18 D: 14,18</p> <p>25",30",36",42",47" HIGH: W: 24,27,30,33,36,39, 42,45,48 H: 25,30,36,42,47 D: 14,18</p> <p>Doors Adjustable Shelves (25H-47H only)</p>	<p>W: 36,39,42,45,48 H: 25,30,36,42,47 D: 14,18</p> <p>Doors Center Divider Adjustable Shelves</p>
	20120	20121	20129	20181
12H 16H 18H				
25H				
30H 36H				
42H 47H				

SLOPE VALANCE – STREAMLINED





Display

Doors extend 1" below cabinet to allow opening without pull hardware.
Slope top units require 16816 slope top cover panel for field installation.
Height (H) denotes cabinet box height.

	Display			
	<p>W: 15,18,21,24 H: 25,30,36,42,47 D: 14,18</p> <p>Right Hinge Display Door Adjustable Shelves</p>	<p>W: 15,18,21,24 H: 25,30,36,42,47 D: 14,18</p> <p>Left Hinge Display Door Adjustable Shelves</p>	<p>W: 30,36 H: 25,30,36,42,47 D: 14,18</p> <p>Display Doors Adjustable Shelves</p>	<p>W: 30,36,42,48 H: 25,30,36,42,47 D: 14,18</p> <p>Display Doors Center Divider Adjustable Shelves</p>
	20130	20131	20136	20182
25H				
30H 36H				
42H 47H				

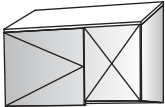
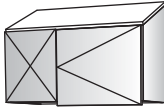
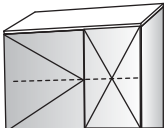
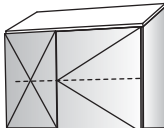
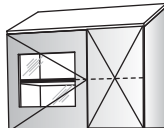
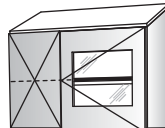
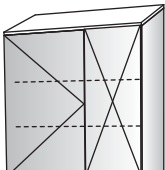
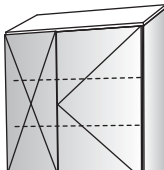
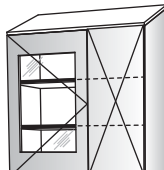
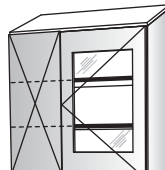
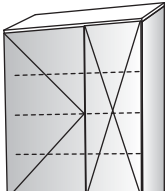
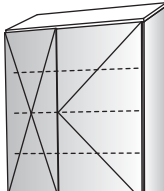
Doors extend 1" below cabinet to allow opening without pull hardware.
Slope top units require 16816 slope top cover panel for field installation.
Height (H) denotes cabinet box height.

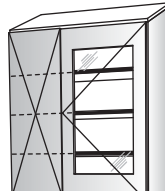
Corner – Blind				
	14" DEEP: W: 33,36 H: 16,18,25,30,36,42,47 D: 14 18" DEEP: W: 36,39 H: 16,18,25,30,36,42,47 D: 18 Right Hinge Door Adjustable Shelves (25H-47H only)	14" DEEP: W: 33,36 H: 16,18,25,30,36,42,47 D: 14 18" DEEP: W: 36,39 H: 16,18,25,30,36,42,47 D: 18 Left Hinge Door Adjustable Shelves (25H-47H only)	14" DEEP: W: 33,36 H: 25,30,36,42,47 D: 14 18" DEEP: W: 36,39 H: 25,30,36,42,47 D: 18 Right Hinge Display Door Adjustable Shelves	14" DEEP: W: 33,36 H: 25,30,36,42,47 D: 14 18" DEEP: W: 36,39 H: 25,30,36,42,47 D: 18 Left Hinge Display Door Adjustable Shelves
	20200	20201	20202	20203
16H 18H				
25H				
30H 36H				
42H 47H				

SLOPE VALANCE – STREAMLINED



Cubicle

Doors extend 1" below cabinet to allow opening without pull hardware.
Slope top units require 16816 slope top cover panel for field installation.
Height (H) denotes cabinet box height.



Cubicle		Cubicle		Cubicle		Cubicle	
<p>Compt. Widths 18W = 7 7/8" 21W = 9 3/8" 24W = 10 7/8"</p>	<p>W: 18,21,24 H: 25,30,36,42,47 D: 14,18</p> <p>Right Hinge Door 3/4" Adjustable Cubicle Shelves Compartment Spacing 3"H min.</p>	<p>W: 18,21,24 H: 25,30,36,42,47 D: 14,18</p> <p>Left Hinge Door 3/4" Adjustable Cubicle Shelves Compartment Spacing 3"H min.</p>	<p>Compt. Widths 30W = 9" 36W = 11" 42W = 13" 48W = 15"</p>	<p>W: 30,36,42,48 H: 25,30,36,42,47 D: 14,18</p> <p>Doors 3/4" Adjustable Cubicle Shelves Compartment Spacing 3"H min.</p>	<p>Compt. Widths 36W = 8" 42W = 9 1/2" 48W = 11"</p>	<p>W: 36,42,48 H: 25,30,36,42,47 D: 14,18</p> <p>Doors 3/4" Adjustable Cubicle Shelves Compartment Spacing 3"H min.</p>	
	20222	20223		20227		20240	
<p>25H 30H 6 Compts.</p>			<p>25H 30H 9 Compts.</p>		<p>25H 30H 12 Compts.</p>		
<p>36H 8 Compts.</p>			<p>36H 12 Compts.</p>		<p>36H 16 Compts.</p>		
<p>42H 47H 10 Compts.</p>			<p>42H 47H 15 Compts.</p>		<p>42H 47H 20 Compts.</p>		

Media Integration / Specialty

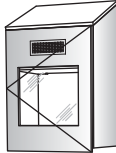
Doors extend 1" below cabinet to allow opening without pull hardware.
Slope top units require 16816 slope top cover panel for field installation.
Height (H) denotes cabinet box height.

Media Integration	
<p>W: 21,24 H: 30 D: 18</p> <p>Right Hinge Display Door Black Vent Grille Adjustable Shelves with Wire Management Slot</p>	<p>W: 21,24 H: 30 D: 18</p> <p>Left Hinge Display Door Black Vent Grille Adjustable Shelves with Wire Management Slot</p>
20500	20501
30H	
	

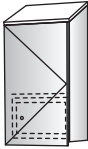
The narcotics locker and cabinet door locks are keyed differently and require separate keys.
Both doors to be keyed differently from all other cabinets.

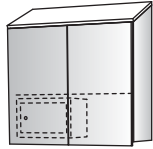
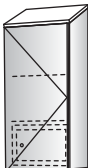
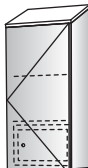
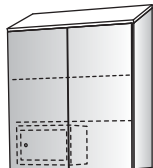
Specialty			
Narcotics Locker			
<p>W: 18,21,24 H: 25,30,36 D: 14,18</p> <p>Locked Right Hinge Door Locked Steel Narcotics Locker Fixed Shelf Adjustable Shelf (36H only)</p>	<p>W: 18,21,24 H: 25,30,36 D: 14,18</p> <p>Locked Left Hinge Door Locked Steel Narcotics Locker Fixed Shelf Adjustable Shelf (36H only)</p>	<p>W: 30,36,39,42,45,48 H: 25,30,36 D: 14,18</p> <p>Locked Doors Locked Steel Narcotics Locker Fixed Shelf Adjustable Shelf (36H only)</p>	
20290	20291	20294	
25H 30H			
			
36H			
			

SLOPE VALANCE – STREAMLINED





Specialty

Doors extend 1" below cabinet to allow opening without pull hardware.
Slope top units require 16816 slope top cover panel for field installation.
Height (H) denotes cabinet box height.

Specialty			Specialty		
Dispensing – Towel/Cup			Dispensing – Towel/Cup/Glove/Tissue		
<p>W: 18,21,24 H: 25,30,36 D: 14,18</p> <p>Right Hinge Door Towel/Cup Dispenser Adjustable Shelves</p>	<p>W: 18,21,24 H: 25,30,36 D: 14,18</p> <p>Left Hinge Door Towel/Cup Dispenser Adjustable Shelves</p>	<p>W: 27,30,33,36,39, 42,45,48 H: 25,30,36 D: 14,18</p> <p>Doors Towel/Cup Dispenser Adjustable Shelves</p>	<p>W: 18,21,24 H: 25,30,36 D: 14,18</p> <p>Right Hinge Door Towel/Cup and Glove/Tissue Dispensers Adjustable Shelf (36H only)</p>	<p>W: 18,21,24 H: 25,30,36 D: 14,18</p> <p>Left Hinge Door Towel/Cup and Glove/Tissue Dispensers Adjustable Shelf (36H only)</p>	<p>W: 36,39,42,45,48 H: 25,30,36 D: 14,18</p> <p>Doors Towel/Cup and Glove/Tissue Dispensers Adjustable Shelf (36H only)</p>
20122	20123	20126	20124	20125	20127
25H					
30H 36H					
<p>TOWEL/CUP DISPENSER Bottom-access dispensing of paper towels and 5 oz. cups.</p>			<p>GLOVE/TISSUE DISPENSER Face-of-door access for gloves or tissues.</p>		

Slope top units require 16816 slope top cover panel for field installation.

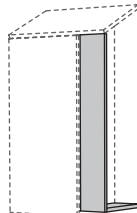
Vertical Scribe	Valance Rail	Front Filler
<p>W: 00 H: 18,25,30,36,42,47 D: 14,18</p> <p>Field Trim to Fit Actual Thickness=3/4" Actual Depth=3" Edgebanding: One Long Edge in Casebody Trim Color and 0.5mm Thickness</p>	<p>W: 48,96 H: 03 D: 00</p> <p>Field Trim to Fit Edgebanding: One Long Edge in Casebody Trim Color and Thickness</p>	<p>W: 02,03,06,09,12 H: 18,25,30,36,42,47 D: 14,18</p> <p>Field Trim to Fit Includes Bottom Closure Panel Edgebanding: One Short Edge in Casebody Trim Color and 0.5mm Thickness</p>
15802	15812	16803
		

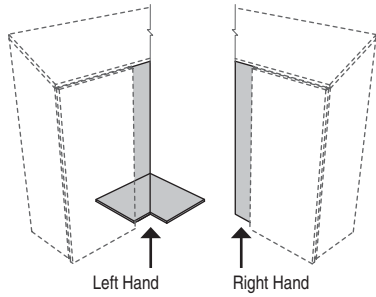
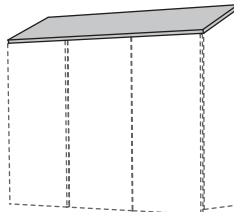
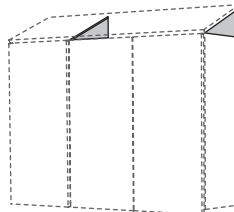
Corner Filler/Closure	Slope Top Cover Panel	Custom Slope Top End Wedge
<p>W: 02,03,06,09,12 H: 18,25,30,36,42,47 D: 14,18</p> <p>Field Trim to Fit Depths (D) Listed are Depths of Cabinets to which Filler/Closure is Attached Each Filler Includes Bottom Closure Panel (shown below with Left Hand Filler) Edgebanding (Corner Filler): Two Short Edges in Casebody Trim Color and 0.5mm Thickness Edgebanding: (Closure): None</p>	<p>W: 36,48,60,72,84,96 H: 00 D: 14,18</p> <p>Shipped in Lengths for Field Trimming Order by Cabinet Depth Based on Standard 25° Rise Edgebanding: One Long and Two Short Edges in Casebody Trim Color and 0.5mm Thickness</p>	<p>Field Cut to Desired Size Provide Height of Rise Required Edgebanding: None</p>
16805	16816	16817
 <p>Left Hand Right Hand</p>		

STREAMLINED VALANCE

Stevens Advantage streamlined valance units are designed the same as wall cabinets, except the doors extend 1" below the cabinet box to allow opening without the need for pull hardware.

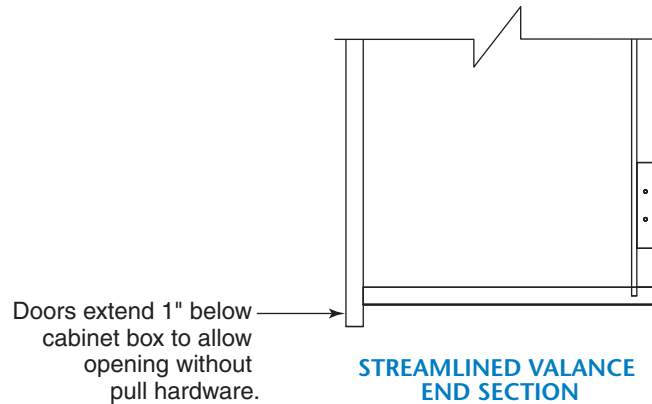

SLOPE TOP

Stevens Advantage slope top units are designed with integral slope ends, eliminating the need for on-the-job fabrication of slope structures. Overlay slope cover panels are shipped with length and end edging for final fit and sizing as installation field conditions may require. Stevens Advantage slope design incorporates a full 3/4" thick slope top on a 25° constant rising slope. Slope top options are available on nominal cabinet depths of 14" and 18". Slope tops not recommended for wall-mounted height above 84", due to possible ceiling interferences. 16816 Slope Top Cover Panels must be specified and ordered separately (not included with cabinet units).

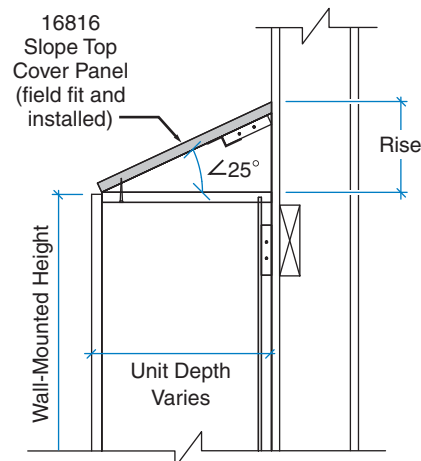

Nominal Unit Depth	Rise	
	inches	mm
14	7	177.9
18	8 ¾	222.6