

Table of Contents

MOBILES



Shelf	3-4
Paper Storage	5-6
Rollout Shelf.....	6
Folder	7
Cubicle	8-9
Bin Storage.....	10
Tray Storage.....	11-13
Drawer	14-15
Combination Storage.....	14-16

(continued on page 2)

Table of Contents *(continued)*



Coat Storage17

Locker17

Wardrobe/Storage.....18

Demonstration Mobile19-21

Specialty22-23

Installation Accessories.....24

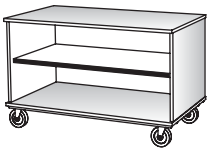
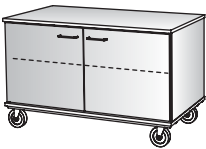
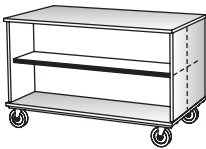
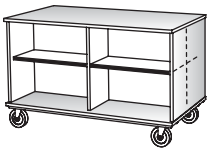
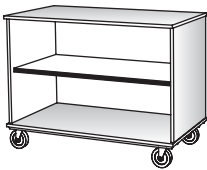
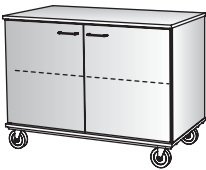
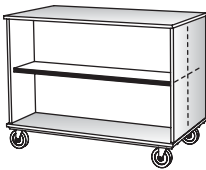
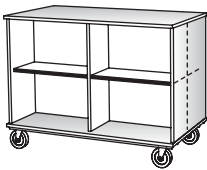
		Shelf			
		W: 36,44,48 H: 31,37 D: 20,24,29 Adjustable Shelf	W: 36,44,48 H: 31,37 D: 20,24,29 Doors Adjustable Shelf	W: 36,44,48 H: 31,37 D: 24,29 Double Sided Adjustable Shelves	W: 36,44,48 H: 31,37 D: 24,29 Double Sided Center Dividers Adjustable Shelves
		60101	60129	60102	60103
30H					
36H					

		Shelf			
		W: 36,44,48 H: 54,66 D: 24,29 Adjustable Shelves	W: 36,44,48 H: 54,66 D: 24,29 Doors Adjustable Shelves	W: 36,44,48 H: 54,66 D: 24,29 Double Sided Adjustable Shelves	W: 36,44,48 H: 54,66 D: 24,29 Double Sided Center Dividers Adjustable Shelves
		60101	60129	60102	60103
55H					
67H					

MOBILES

Shelf



Shelf

W: 36,44,48
H: 31,37
D: 20,24,29

Center Divider
Adjustable Shelves

W: 36,44,48
H: 31,37
D: 20,24,29

Doors
Center Divider
Adjustable Shelves

60138

60181

30H

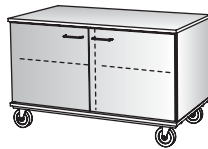
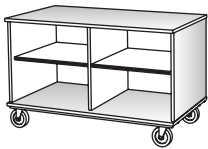

36H

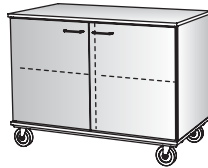
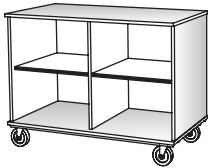

Shelf

W: 36,44,48
H: 54,66
D: 24,29

Center Divider
Adjustable Shelves

W: 36,44,48
H: 54,66
D: 24,29

Doors
Center Divider
Adjustable Shelves

W: 36,44,48
H: 54,66
D: 24,29

1/3-2/3 Configuration
Vertical Divider
Adjustable Shelves

W: 36,44,48
H: 54,66
D: 24,29

1/3-2/3 Configuration
Doors
Vertical Divider
Adjustable Shelves

60138

60181

60184



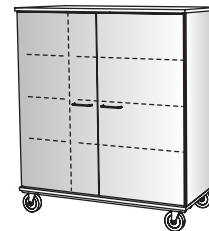
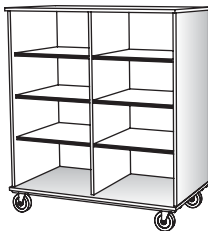

60185

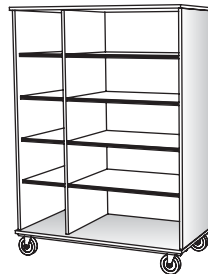
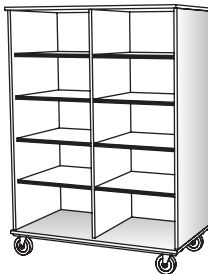

55H

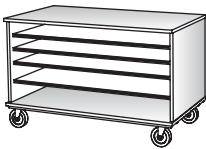
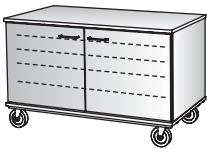
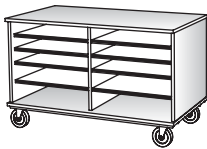
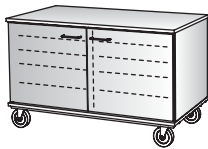
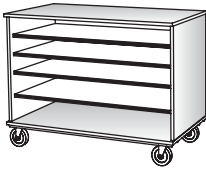

67H





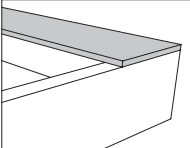

Paper Storage		Paper Storage		Paper Storage	
<p>Max. Paper Widths 36W = 34" 44W = 42" 48W = 46"</p>	<p>W: 36,44,48 H: 31,37 D: 20,24,29,34</p> <p>Adjustable Shelves Max. Paper Depth: 4" Less Than Unit Depth</p>	<p>W: 36,44,48 H: 31,37 D: 20,24,29,34</p> <p>Doors Adjustable Shelves Max. Paper Depth: 5" Less Than Unit Depth</p>	<p>Max. Paper Widths 36W = 16½" 44W = 20½" 48W = 22½"</p>	<p>W: 36,44,48 H: 31,37 D: 20,24,29,34</p> <p>Center Divider Adjustable Shelves Max. Paper Depth: 4" Less Than Unit Depth</p>	<p>W: 36,44,48 H: 31,37 D: 20,24,29,34</p> <p>Doors Center Divider Adjustable Shelves Max. Paper Depth: 5" Less Than Unit Depth</p>
	60116	60115		60118	60117
30H			30H		
36H			36H		

Paper Storage		Paper Storage	
<p>Full-Width Drawers</p> <p>Max. Paper Widths 36W = 31" 44W = 39" 48W = 43"</p> <p>Half-Width Drawers</p> <p>Max. Paper Widths 36W = 15" 44W = 19" 48W = 21"</p>	<p>W: 36,44,48 H: 37 D: 24,29,34</p> <p>5 Equal Full Extension Drawers Max. Paper Depth: 6" Less Than Unit Depth</p>	<p>W: 36,44,48 H: 37 D: 24,29,34</p> <p>Equal Full Extension Drawers: 2 Half-Width, 4 Full-Width Max. Paper Depth: 6" Less Than Unit Depth</p>	
	60393	60394	
36H			
	 <p>Paper storage drawers include rear retaining hoods.</p>		

MOBILES

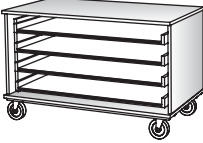
Paper Storage / Rollout Shelf

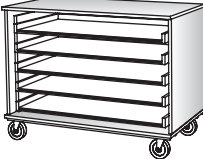





Paper Storage/Rollout Shelf		
Max. Paper Widths 36W = 30" 44W = 38" 48W = 42"	W: 36,44,48 H: 31,37 D: 24,29 Full Extension Rollout Shelves Max. Paper Depth: 5" Less Than Unit Depth	W: 36,44,48 H: 31,37 D: 24,29 Doors Full Extension Rollout Shelves Max. Paper Depth: 5" Less Than Unit Depth
	60492 30H 4 Rollout Shelves 	60493 
36H 5 Rollout Shelves 		

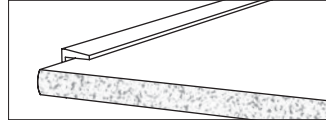

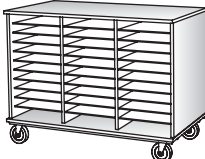

Paper Storage/Rollout Shelf	
Max. Paper Widths 36W = 30" 44W = 38" 48W = 42"	W: 36,44,48 H: 66 D: 24,29 Doors Adjustable Shelf 5 Full Extension Rollout Shelves Max. Paper Depth: 5" Less Than Unit Depth
60494 67H 	

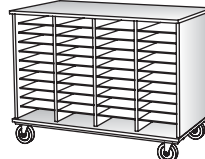
Folder

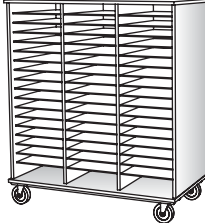
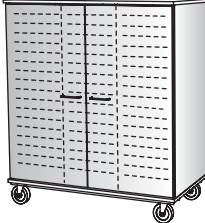
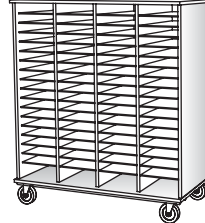

1/4"-thick folder shelves are held securely with translucent, low profile shelf supports. All edges unfinished. Front edge unfinished and shaped.

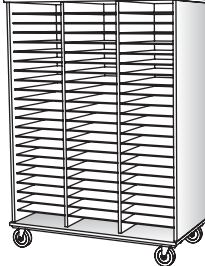
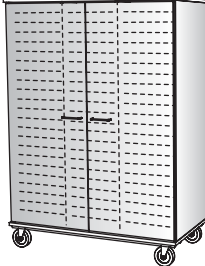
Folder		Folder		Folder	
Compt. Width 15"	W: 48 H: 37 D: 24 1/4" Folder Shelves, Adjustable and Removable on 1 1/4" Centers Compartments 2 1/4"H min.	W: 48 H: 37 D: 24 Doors 1/4" Folder Shelves, Adjustable and Removable on 1 1/4" Centers Compartments 2 1/4"H min.	Compt. Width 11"	W: 48 H: 37 D: 24 1/4" Folder Shelves, Adjustable and Removable on 1 1/4" Centers Compartments 2 1/4"H min.	W: 48 H: 37 D: 24 Doors 1/4" Folder Shelves, Adjustable and Removable on 1 1/4" Centers Compartments 2 1/4"H min.
	60647	60648		60649	60650
36H 33 Compts.			36H 44 Compts.		

Folder		Folder		Folder	
Compt. Width 15"	W: 48 H: 54,66 D: 24 1/4" Folder Shelves, Adjustable and Removable on 1 1/4" Centers Compartments 2 1/4"H min.	W: 48 H: 54,66 D: 24 Doors 1/4" Folder Shelves, Adjustable and Removable on 1 1/4" Centers Compartments 2 1/4"H min.	Compt. Width 11"	W: 48 H: 54,66 D: 24 1/4" Folder Shelves, Adjustable and Removable on 1 1/4" Centers Compartments 2 1/4"H min.	W: 48 H: 54,66 D: 24 Doors 1/4" Folder Shelves, Adjustable and Removable on 1 1/4" Centers Compartments 2 1/4"H min.
	60647	60648		60649	60650
55H 54 Compts.			55H 72 Compts.		
67H 69 Compts.			67H 92 Compts.		





MOBILES



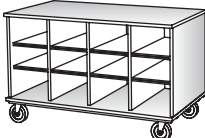

Cubicle

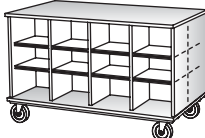
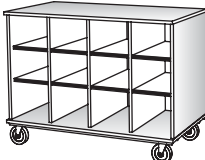
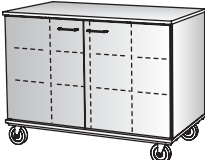

Cubicle			
Compt. Widths 36W = 11" 44W = 13½" 48W = 15"	W: 36,44,48 H: 31,37 D: 20,24 ¾" Adjustable Cubicle Shelves Compartment Spacing 3"H min.	W: 36,44,48 H: 31,37 D: 20,24 Doors ¾" Adjustable Cubicle Shelves Compartment Spacing 3"H min.	W: 36,44,48 H: 31,37 D: 24,29 Double Sided ¾" Adjustable Cubicle Shelves Compartment Spacing 3"H min.
	60226	60227	60233
30H 9 Compts.			30H 18 Compts.
36H 9 Compts.			36H 18 Compts.

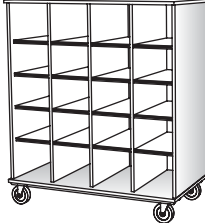
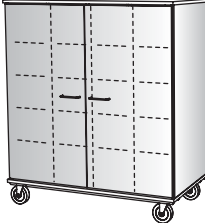
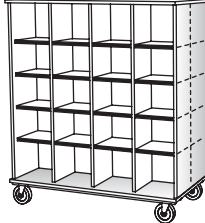
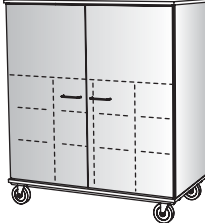
Cubicle				
Compt. Widths 36W = 11" 44W = 13½" 48W = 15"	W: 36,44,48 H: 54,66 D: 24 ¾" Adjustable Cubicle Shelves Compartment Spacing 3"H min.	W: 36,44,48 H: 54,66 D: 24 Doors ¾" Adjustable Cubicle Shelves Compartment Spacing 3"H min.	W: 36,44,48 H: 54,66 D: 24,29 Double Sided ¾" Adjustable Cubicle Shelves Compartment Spacing 3"H min.	W: 36,44,48 H: 54,66 D: 24 Doors Adjustable Shelf (67H only) ¾" Adjustable Cubicle Shelves Compartment Spacing 3"H min.
	60226	60227	60233	60232
55H 15 Compts.			55H 30 Compts. 	55H 9 Compts.
67H 21 Compts.			67H 42 Compts. 	67H 9 Compts.

Cubicle			
Compt. Widths 36W = 8" 44W = 10" 48W = 11"	W: 36,44,48 H: 31,37 D: 20,24 ¾" Adjustable Cubicle Shelves Compartment Spacing 3"H min.	W: 36,44,48 H: 31,37 D: 20,24 Doors ¾" Adjustable Cubicle Shelves Compartment Spacing 3"H min.	W: 36,44,48 H: 31,37 D: 24,29 Double Sided ¾" Adjustable Cubicle Shelves Compartment Spacing 3"H min.
	60239	60240	60235
30H 12 Compts.			30H 24 Compts. 
36H 12 Compts.			36H 24 Compts. 

Cubicle				
Compt. Widths 36W = 8" 44W = 10" 48W = 11"	W: 36,44,48 H: 54,66 D: 24 ¾" Adjustable Cubicle Shelves Compartment Spacing 3"H min.	W: 36,44,48 H: 54,66 D: 24 Doors ¾" Adjustable Cubicle Shelves Compartment Spacing 3"H min.	W: 36,44,48 H: 54,66 D: 24,29 Double Sided ¾" Adjustable Cubicle Shelves Compartment Spacing 3"H min.	W: 36,44,48 H: 54,66 D: 24 Doors Adjustable Shelf (67H only) ¾" Adjustable Cubicle Shelves Compartment Spacing 3"H min.
	60239	60240	60235	60247
55H 20 Compts.			55H 40 Compts. 	55H 12 Compts. 
67H 28 Compts.			67H 56 Compts. 	67H 12 Compts. 

MOBILES

Bin Storage



SA910: 12 $\frac{1}{4}$ W x 3H x 16 $\frac{3}{4}$ D



SA911: 12 $\frac{1}{4}$ W x 6H x 16 $\frac{3}{4}$ D

Bin Storage

W: 44
H: 31,37
D: 24

Molded Translucent Bins

W: 44
H: 31,37
D: 24

Doors
Molded Translucent Bins

W: 44
H: 31,37
D: 24

Molded Translucent Bins

W: 44
H: 31,37
D: 24

Doors
Molded Translucent Bins

60242

30H
(12) SA910
Bins

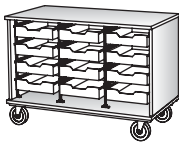

60243

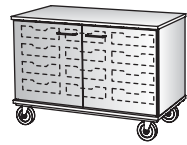

60248

30H
(6) SA911
Bins

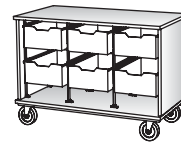

60249

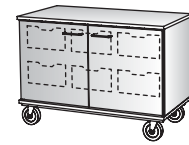

36H
(18) SA910
Bins

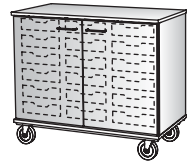
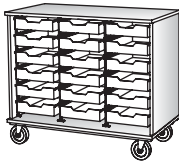

36H
(9) SA911
Bins

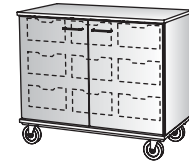
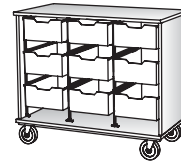

Bin Storage

W: 44
H: 54,66
D: 24

Molded Translucent Bins

W: 44
H: 54,66
D: 24

Doors
Molded Translucent Bins

W: 44
H: 54,66
D: 24

Molded Translucent Bins

W: 44
H: 54,66
D: 24

Doors
Molded Translucent Bins

60242

55H
(27) SA910
Bins

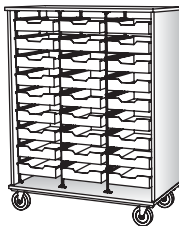

60243



60248

55H
(3) SA910
Bins
(12) SA911
Bins



60249



67H
(36) SA910
Bins

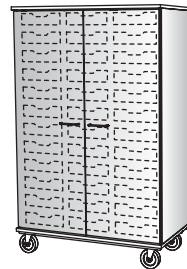
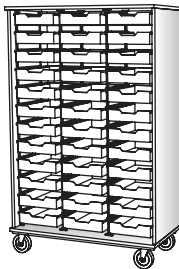

67H
(18) SA911
Bins













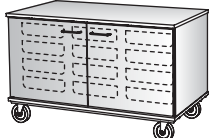

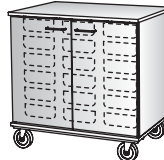
SA901: 14 1/4W x 3 1/2H x 19D

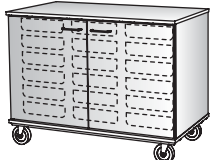

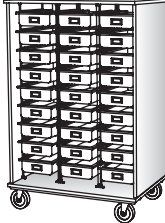
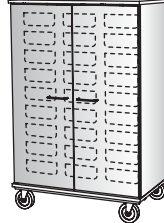
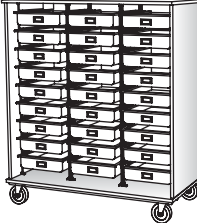
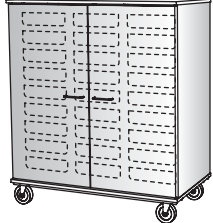
SA902: 10W x 3 1/2H x 19D

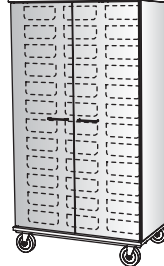
Tray Storage		Tray Storage		Tray Storage			
<p>W: 36 H: 31,37 D: 24</p> <p>Molded Trays with Card Holder</p>	<p>W: 36 H: 31,37 D: 24</p> <p>Doors Molded Trays with Card Holder</p>	<p>W: 48 H: 31,37 D: 24</p> <p>Molded Trays with Card Holder</p>	<p>W: 48 H: 31,37 D: 24</p> <p>Doors Molded Trays with Card Holder</p>	<p>60270</p> <p>30H (12) SA902 Trays</p> 	<p>60271</p> 	<p>60274</p> <p>30H (12) SA901 Trays</p> 	<p>60275</p> 
<p>36H (18) SA902 Trays</p> 		<p>36H (18) SA901 Trays</p> 					

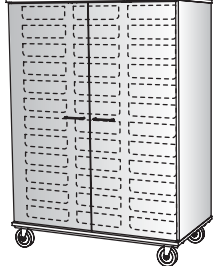
Tray Storage		Tray Storage		Tray Storage			
<p>W: 36 H: 54,66 D: 24</p> <p>Molded Trays with Card Holder</p>	<p>W: 36 H: 54,66 D: 24</p> <p>Doors Molded Trays with Card Holder</p>	<p>W: 48 H: 54,66 D: 24</p> <p>Molded Trays with Card Holder</p>	<p>W: 48 H: 54,66 D: 24</p> <p>Doors Molded Trays with Card Holder</p>	<p>60270</p> <p>55H (27) SA902 Trays</p> 	<p>60271</p> 	<p>60274</p> <p>55H (27) SA901 Trays</p> 	<p>60275</p> 
<p>67H (36) SA902 Trays</p> 		<p>67H (36) SA901 Trays</p> 					

MOBILES

Tray Storage



SA902: 10W x 3 1/2H x 19D

Tray Storage

W: 48
H: 31,37
D: 24

Molded Trays with Card Holder

W: 48
H: 31,37
D: 24

Doors
Molded Trays with Card Holder

60281

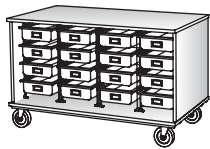

30H
(16) SA902
Trays

60282

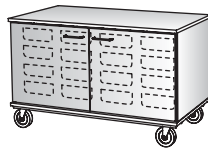

36H
(24) SA902
Trays

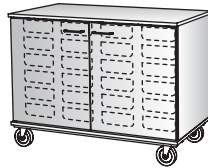
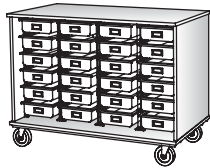

Tray Storage

W: 48
H: 54,66
D: 24

Molded Trays with Card Holder

W: 48
H: 54,66
D: 24

Doors
Molded Trays with Card Holder

60281

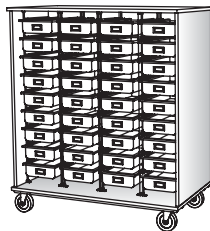

55H
(36) SA902
Trays

60282

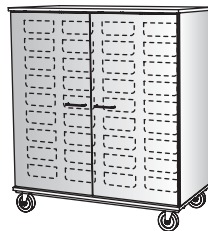

67H
(48) SA902
Trays

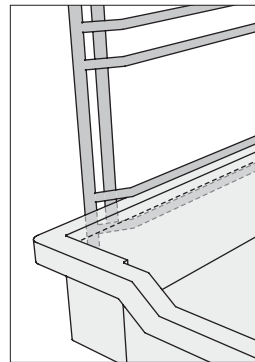
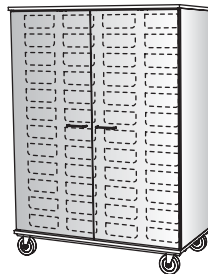

Bin and tray racks have captured runner rail to reduce tray tipout.



SA901: 14 $\frac{1}{4}$ W x 3 $\frac{1}{2}$ H x 19D

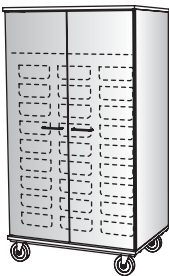
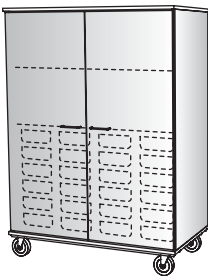

SA902: 10W x 3 $\frac{1}{2}$ H x 19D

Tray Storage			
	<p>W: 36 H: 66 D: 24</p> <p>Upper Compartment (27) SA902 Molded Trays with Card Holder</p>	<p>W: 36 H: 66 D: 24</p> <p>Doors Upper Compartment (27) SA902 Molded Trays with Card Holder</p>	<p>W: 48 H: 66 D: 24</p> <p>Doors Adjustable Shelf (24) SA902 Molded Trays with Card Holder</p>
	60283	60284	60310
67H			

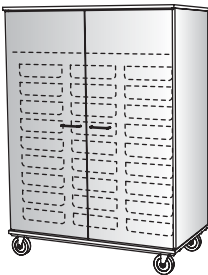
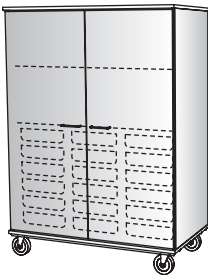
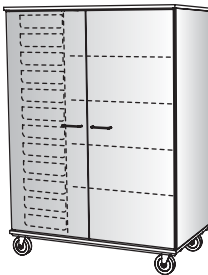
Tray Storage				
	<p>W: 48 H: 66 D: 24</p> <p>Upper Compartment (27) SA901 Molded Trays with Card Holder</p>	<p>W: 48 H: 66 D: 24</p> <p>Doors Upper Compartment (27) SA901 Molded Trays with Card Holder</p>	<p>W: 48 H: 66 D: 24</p> <p>Doors Adjustable Shelf (18) SA901 Molded Trays with Card Holder</p>	<p>W: 48 H: 66 D: 24</p> <p>1/3-2/3 Configuration Doors Vertical Divider Left: (12) SA901 Molded Trays with Card Holder Right: Adjustable Shelves</p>
	60285	60286	60306	60599
67H				

MOBILES













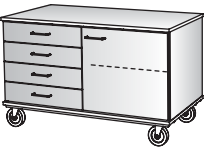

Drawer / Combination Storage



	Drawer			Combination Storage	
	W: 36,44,48 H: 31,37 D: 24 3 Equal Drawers	W: 36,44,48 H: 31,37 D: 24 Equal Drawers: 2 Half-Width, 2 Full-Width	W: 36,44,48 H: 31,37 D: 24 6 Equal Drawers	W: 36,44,48 H: 31,37 D: 24 Right Hinge Door Adjustable Shelf 3 Equal Drawers	W: 36,44,48 H: 31,37 D: 24 Left Hinge Door Adjustable Shelf 3 Equal Drawers
	60334	60343	60344	60338	60339
30H					
36H					

	Combination Storage				
	W: 36,44,48 H: 66 D: 24 Doors Center Divider Adjustable Shelves 3 Equal Drawers	W: 36,44,48 H: 66 D: 24 Doors Center Divider Adjustable Shelves Equal Drawers: 2 Half-Width, 2 Full-Width	W: 36,44,48 H: 66 D: 24 Doors Center Divider Adjustable Shelves 6 Equal Drawers	W: 36,44,48 H: 66 D: 24 Doors Center Divider Right: Adjustable Shelves Left: Adjustable Shelf, 3 Equal Drawers	W: 36,44,48 H: 66 D: 24 Doors Center Divider Left: Adjustable Shelves Right: Adjustable Shelf, 3 Equal Drawers
	60336	60349	60346	60347	60348
67H					

Drawer / Combination Storage

		Drawer			Combination Storage	
		W: 36,44,48 H: 31,37 D: 24 4 Equal Drawers	W: 36,44,48 H: 31,37 D: 24 Equal Drawers: 2 Half-Width, 3 Full-Width	W: 36,44,48 H: 31,37 D: 24 8 Equal Drawers	W: 36,44,48 H: 31,37 D: 24 Right Hinge Door Adjustable Shelf 4 Equal Drawers	W: 36,44,48 H: 31,37 D: 24 Left Hinge Door Adjustable Shelf 4 Equal Drawers
		60371	60382	60383	60381	60380
30H						
36H						
		Combination Storage				
		W: 36,44,48 H: 66 D: 24 Doors Center Divider Adjustable Shelves 4 Equal Drawers	W: 36,44,48 H: 66 D: 24 Doors Center Divider Adjustable Shelves Equal Drawers: 2 Half-Width, 3 Full-Width	W: 36,44,48 H: 66 D: 24 Doors Center Divider Adjustable Shelves 8 Equal Drawers	W: 36,44,48 H: 66 D: 24 Doors Center Divider Right: Adjustable Shelves Left: Adjustable Shelf, 4 Equal Drawers	W: 36,44,48 H: 66 D: 24 Doors Center Divider Left: Adjustable Shelves Right: Adjustable Shelf, 4 Equal Drawers
		60375	60386	60388	60376	60377
67H						

MOBILES

Combination Storage



Combination Storage

W: 36,44,48
H: 37
D: 24

Drawer
Doors
Adjustable Shelf

W: 36,44,48
H: 37
D: 24

2 Equal Drawers
Doors
Center Divider
Adjustable Shelves

60430

60432

36H

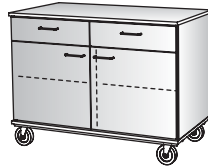

Combination Storage

W: 48
H: 66
D: 24

Sliding Glass Doors
Center Divider
Adjustable Shelves
4 Equal Drawers

W: 36,44,48
H: 66
D: 24



Upper/Lower Doors
Center Dividers
Adjustable Shelves
2 Equal Drawers

60160

60434

67H

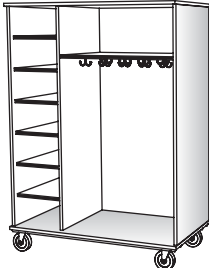
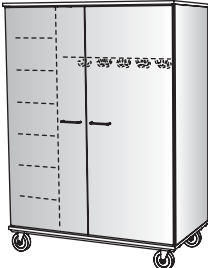
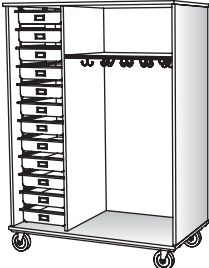
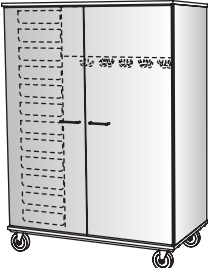

Coat Storage				
	<p>W: 48 H: 67 D: 24</p> <p>1/3-2/3 Configuration Vertical Divider Left: Adjustable Shelves Right: Adjustable Shelf, 10 Double Hooks</p>	<p>W: 48 H: 67 D: 24</p> <p>1/3-2/3 Configuration Doors Vertical Divider Left: Adjustable Shelves Right: Adjustable Shelf, 10 Double Hooks</p>	<p>W: 48 H: 67 D: 24</p> <p>1/3-2/3 Configuration Vertical Divider Left: (12) SA901 Molded Trays with Card Holder Right: Adjustable Shelf, 10 Double Hooks</p>	<p>W: 48 H: 67 D: 24</p> <p>1/3-2/3 Configuration Doors Vertical Divider Left: (12) SA901 Molded Trays with Card Holder Right: Adjustable Shelf, 10 Double Hooks</p>
	60186	60187	60590	60591
67H				
				SA901: 14 1/4W x 3 1/2H x 19D

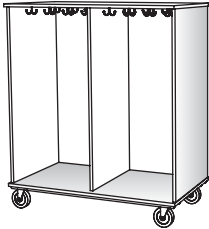
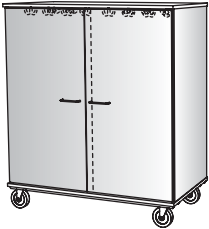
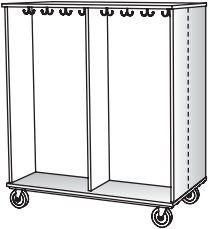
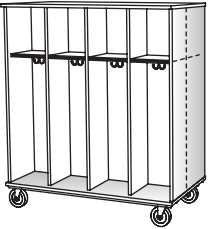
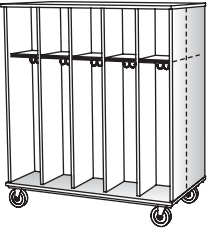
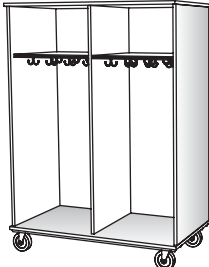
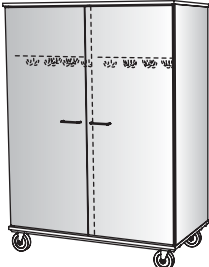
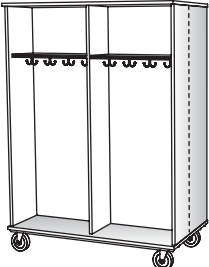
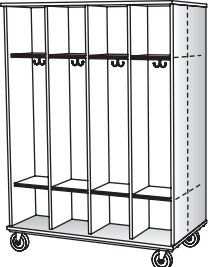
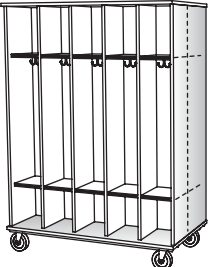
Coat Storage			Locker		
	<p>W: 48 H: 54,66 D: 24</p> <p>Center Divider 16 Double Hooks Adjustable Shelves (67H only)</p>	<p>W: 48 H: 54,66 D: 24</p> <p>Doors Center Divider 16 Double Hooks Adjustable Shelves (67H only)</p>	<p>W: 48 H: 54,66 D: 24,29</p> <p>Double Sided Center Dividers 16 Double Hooks Adjustable Shelves (67H only)</p>	<p>W: 48 H: 54,66 D: 24,29</p> <p>Double Sided 8 Compartments (11W) 8 Double Hooks Adjustable Shelves</p>	<p>W: 48 H: 54,66 D: 24,29</p> <p>Double Sided 10 Compartments (8 5/8W) 10 Double Hooks Adjustable Shelves</p>
	60582	60583	60584	60612	60613
55H					
67H					

MOBILES

Wardrobe / Storage



Wardrobe/Storage

W: 36
H: 66
D: 24

Adjustable Shelf
Hanger Bar

60555

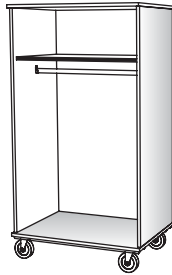

W: 36
H: 66
D: 24

Doors
Adjustable Shelf
Hanger Bar

60556

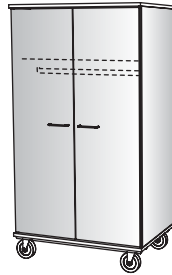

W: 48
H: 66
D: 24

Center Divider
Adjustable Shelves
Hanger Bars

60560

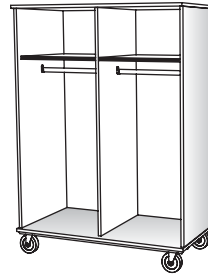

W: 48
H: 66
D: 24

Doors
Center Divider
Adjustable Shelves
Hanger Bars

60561



67H

Wardrobe/Storage

W: 48
H: 66
D: 24

1/3-2/3 Configuration
Doors
Vertical Divider
Left: Wardrobe Hook, Mirror
Right: Adjustable Shelves
10945 Pin Tray Available Separately
(see Accessories section)

60603

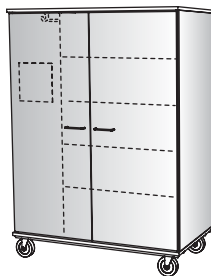

W: 48
H: 66
D: 24

1/3-2/3 Configuration
Doors
Vertical Divider
Left: Wardrobe Hook, Mirror
Right: Adjustable Shelves, 2 Full
Extension Letter File Drawers
10945 Pin Tray Available Separately
(see Accessories section)

60606

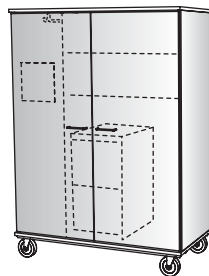

W: 48
H: 66
D: 24

1/3-2/3 Configuration
Doors
Vertical Divider
Left: Wardrobe Hook, Mirror
Right: Adjustable Shelves, 2 Full
Extension Legal File Drawers
10945 Pin Tray Available Separately
(see Accessories section)

60609

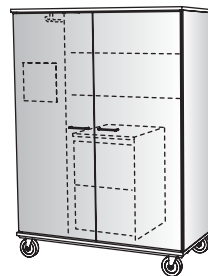





67H

Letter and legal file drawers are designed for front-to-back filing.
Optional crossbars allow side filing.
See Installation Accessories.

Demonstration Mobile

Demonstration mobiles with mirror are designed to roll through a standard 6'8" doorway.
Distance from floor to mirror pivot point is 76".

Demonstration Mobile				
	<p>W: 48 H: 37 D: 24,29</p> <p>Demonstration Mirror Left Hinge Door Adjustable Shelf 3 Equal Drawers</p>	<p>W: 59 H: 37 D: 24,29</p> <p>Demonstration Mirror Doors Adjustable Shelves 3 Equal Drawers</p>	<p>W: 48 H: 37 D: 24,29</p> <p>Demonstration Mirror Left Hinge Door Adjustable Shelf 4 Equal Drawers</p>	<p>W: 59 H: 37 D: 24,29</p> <p>Demonstration Mirror Doors Adjustable Shelves 4 Equal Drawers</p>
	60733	60731	60728	60729
36H				

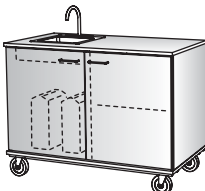
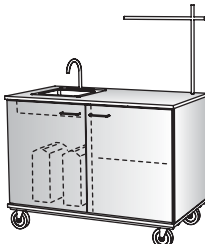
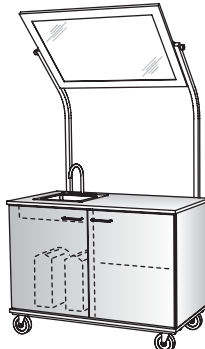
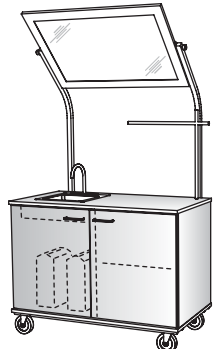
Demonstration Mobile				
	<p>W: 48 H: 37 D: 24,29</p> <p>Sink with Galley Pump Doors Adjustable Shelf 2 Jericans</p>	<p>W: 48 H: 37 D: 24,29</p> <p>Apparatus Rod and Socket Sink with Galley Pump Doors Adjustable Shelf 2 Jericans</p>	<p>W: 48 H: 36 D: 24,29</p> <p>Demonstration Mirror Sink with Galley Pump Doors Adjustable Shelf 2 Jericans</p>	<p>W: 48 H: 36 D: 24,29</p> <p>Demonstration Mirror Apparatus Rod and Socket Sink with Galley Pump Doors Adjustable Shelf 2 Jericans</p>
	60743	60726	60744	60745
36H				

MOBILES



Demonstration Mobile

Demonstration mobiles with mirror are designed to roll through a standard 6'8" doorway.
Distance from floor to mirror pivot point is 76".

Demonstration Mobile

W: 48
H: 37
D: 24,29

Sink with Galley Pump
Left Hinge Door
2 Jericans
3 Equal Drawers

60739



W: 48
H: 37
D: 24,29

Apparatus Rod and Socket
Sink with Galley Pump
Left Hinge Door
2 Jericans
3 Equal Drawers

60727



W: 48
H: 37
D: 24,29

Demonstration Mirror
Sink with Galley Pump
Left Hinge Door
2 Jericans
3 Equal Drawers

60740

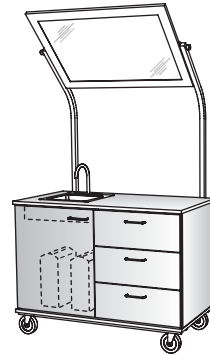

W: 48
H: 37
D: 24,29

Demonstration Mirror
Apparatus Rod and Socket
Sink with Galley Pump
Left Hinge Door
2 Jericans
3 Equal Drawers

60746

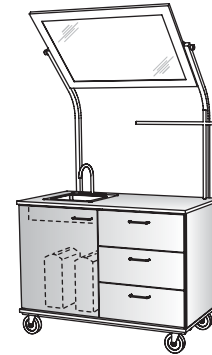

36H

Demonstration Mobile

W: 48
H: 37
D: 24,29

Sink with Galley Pump
Left Hinge Door
2 Jericans
4 Equal Drawers

60747



W: 48
H: 37
D: 24,29

Apparatus Rod and Socket
Sink with Galley Pump
Left Hinge Door
2 Jericans
4 Equal Drawers

60748



W: 48
H: 37
D: 24,29

Demonstration Mirror
Sink with Galley Pump
Left Hinge Door
2 Jericans
4 Equal Drawers

60749



W: 48
H: 37
D: 24,29

Demonstration Mirror
Apparatus Rod and Socket
Sink with Galley Pump
Left Hinge Door
2 Jericans
4 Equal Drawers

60750



36H

Demonstration Mobile

Demonstration mobiles with mirror are designed to roll through a standard 6'8" doorway.
Distance from floor to mirror pivot point is 76".

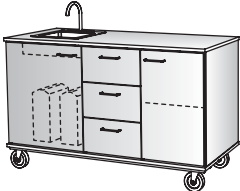
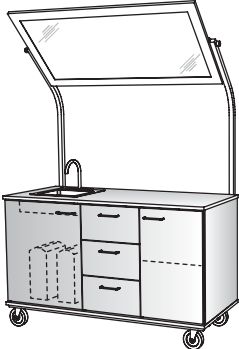
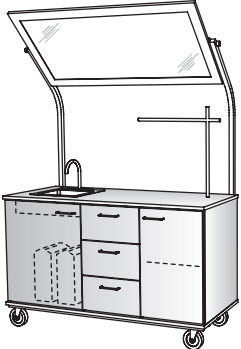
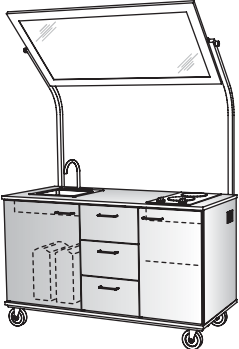
Demonstration Mobile				
	<p>W: 59 H: 37 D: 24,29</p> <p>Sink with Galley Pump Doors Adjustable Shelf 2 Jericans 3 Equal Drawers</p>	<p>W: 59 H: 37 D: 24,29</p> <p>Demonstration Mirror Sink with Galley Pump Doors Adjustable Shelf 2 Jericans 3 Equal Drawers</p>	<p>W: 59 H: 37 D: 24,29</p> <p>Demonstration Mirror Apparatus Rod and Socket Sink with Galley Pump Doors Adjustable Shelf 2 Jericans 3 Equal Drawers</p>	<p>W: 59 H: 37 D: 24,29</p> <p>Demonstration Mirror Sink with Galley Pump 2-Burner Cooktop Doors 2 Jericans Adjustable Shelf 3 Equal Drawers</p>
	60741	60742	60736	60732
36H				

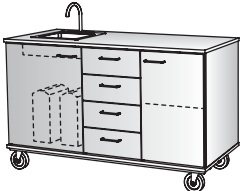
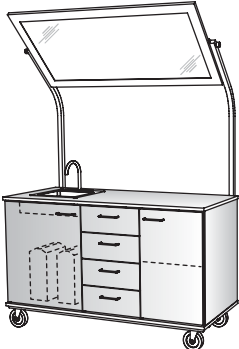
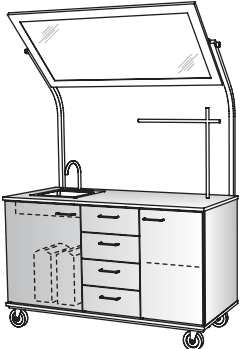
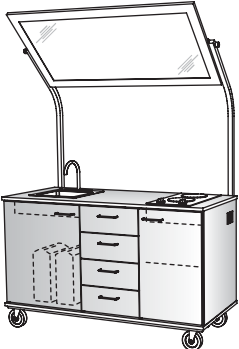
Demonstration Mobile				
	<p>W: 59 H: 37 D: 24,29</p> <p>Sink with Galley Pump Doors Adjustable Shelf 2 Jericans 4 Equal Drawers</p>	<p>W: 59 H: 37 D: 24,29</p> <p>Demonstration Mirror Sink with Galley Pump Doors Adjustable Shelf 2 Jericans 4 Equal Drawers</p>	<p>W: 59 H: 37 D: 24,29</p> <p>Demonstration Mirror Apparatus Rod and Socket Sink with Galley Pump Doors Adjustable Shelf 2 Jericans 4 Equal Drawers</p>	<p>W: 59 H: 37 D: 24,29</p> <p>Demonstration Mirror Sink with Galley Pump 2-Burner Cooktop Doors 2 Jericans Adjustable Shelf 4 Equal Drawers</p>
	60751	60752	60753	60730
36H				

Specialty

Instructor Podium

W: 36,48
H: 41
D: 24

Podium
Adjustable Shelf
Drawer
2 Full Extension Letter File Drawers
All Exterior Color

60720

42H



Letter file drawers are designed for front-to-back filing.
Optional crossbars allow side filing. See Installation Accessories.

Specialty

Technology Storage

W: 48
H: 37
D: 24

Locked Doors
Adjustable Shelves
Storage for 20 Laptops
(1) SA910 Molded
Translucent Bin

60119

36H

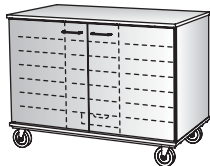

SA910: 12 $\frac{1}{4}$ W x 3H x 16 $\frac{3}{4}$ D

W: 48
H: 66
D: 24



Locked Doors
Left: Adjustable Shelves
Right: Computer Compartment,
Adjustable Printer Shelf,
Fixed CPU and Monitor Shelf,
Pullout Keyboard Tray on Full
Extension Slides

60610

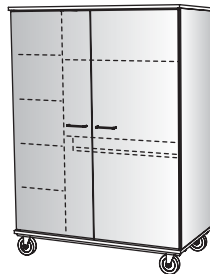
67H

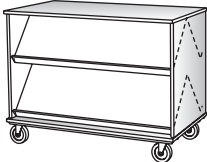
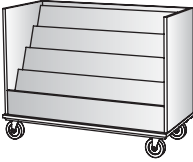
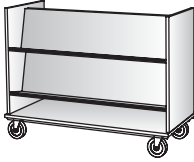

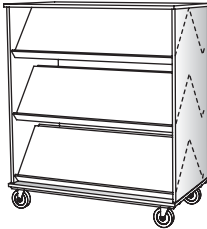
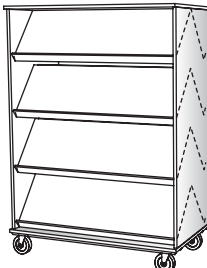
Specialty			
	Magazine Shelf	Periodical Display	Sloped Book Truck
	W: 48 H: 36 D: 24 Double Sided 4 Sloped Magazine Shelves	W: 36,48 H: 36 D: 20 4 Display Shelves All Exterior Color	W: 36,48 H: 36 D: 20 Double Sided Access 4 Fixed Sloped Display Shelves All Exterior Color
	60174	60755	60757
36H			

Specialty			
	Magazine Shelf		
	W: 48 H: 54,66 D: 24 Double Sided 55H=6 Sloped Magazine Shelves 67H=8 Sloped Magazine Shelves	W: 48 H: 67 D: 24 2 Sloped Magazine Shelves Lower Doors Adjustable Shelf	W: 48 H: 67 D: 24 2 Sloped Magazine Shelves 4 Equal Drawers
	60174	60165	60166
55H			
67H			

MOBILES

Installation Accessories



Demonstration Mirror

W: 48.59
H: 76
D: 26

For Attachment to 36H Mobile Cabinets
 W = Mobile Cabinet Width
 48W = 43W Mirror Frame
 59W = 54W Mirror Frame
 Distance from Floor to Mirror Pivot = 76"

10960

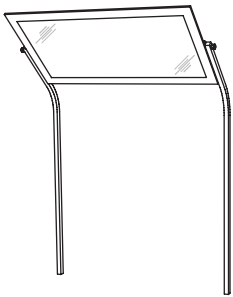

File Crossbars

W: 16
H: 01
D: 00

Pair of Crossbars for 16W File Drawers (Letter)
 Allow Side Filing

10896

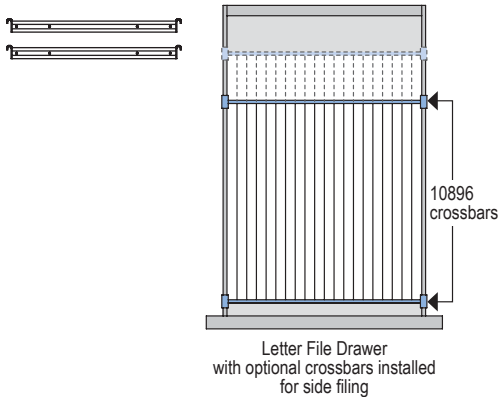

W: 19
H: 01
D: 00

Pair of Crossbars for 19W File Drawers (Legal)
 Allow Side Filing

10897

