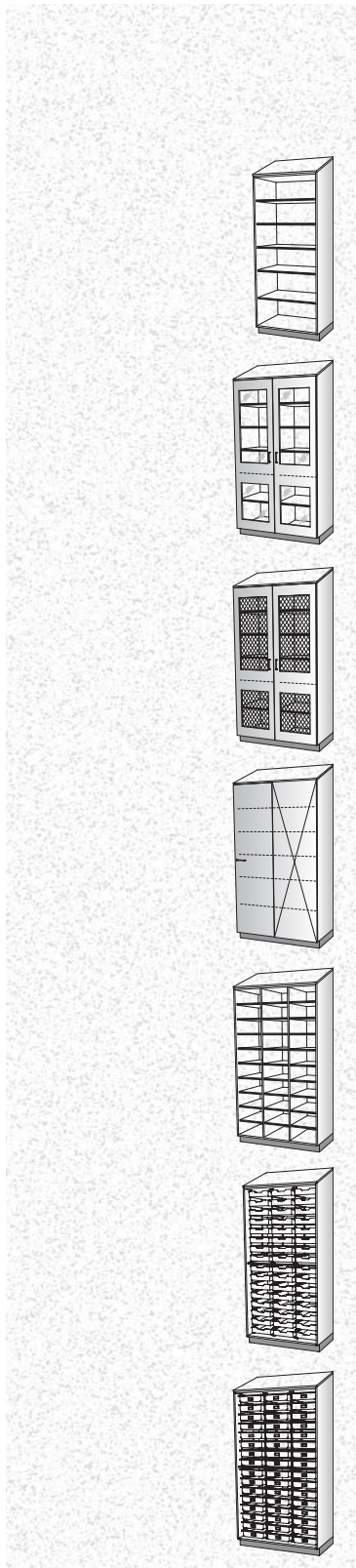

Table of Contents

SLOPE TALL



Shelf5-7

Display8-9

Expanded Metal Door9

Corner10

Cubicle11-13

Bin Storage14

Tray Storage15-19

(continued on page 2)

Table of Contents *(continued)*

SLOPE TALL

Folder.....	20
File Drawer.....	21-22
Combination Storage.....	23-29
Wardrobe.....	30-31
Wardrobe/Storage.....	32-36
Armoire.....	37
Display/Trophy.....	38

(continued on page 3)

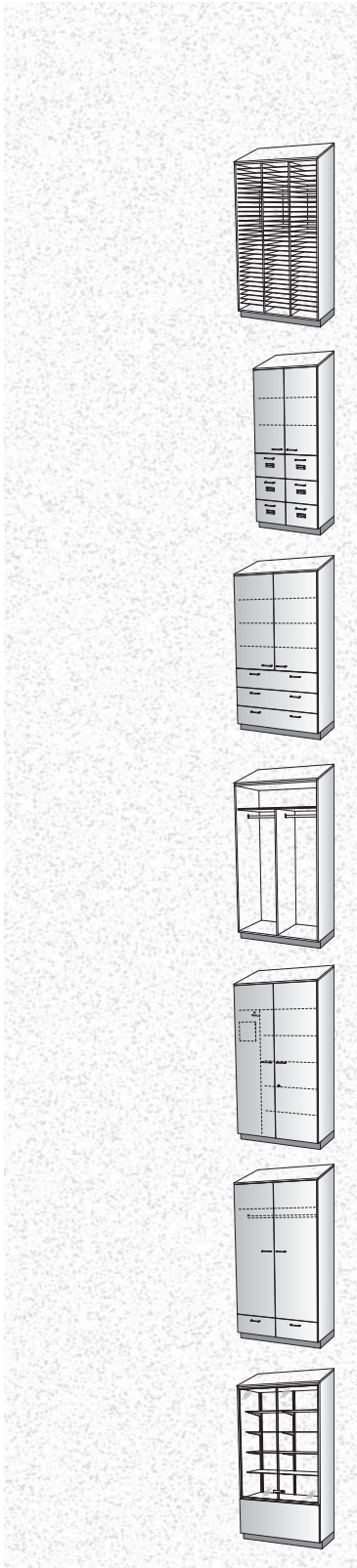
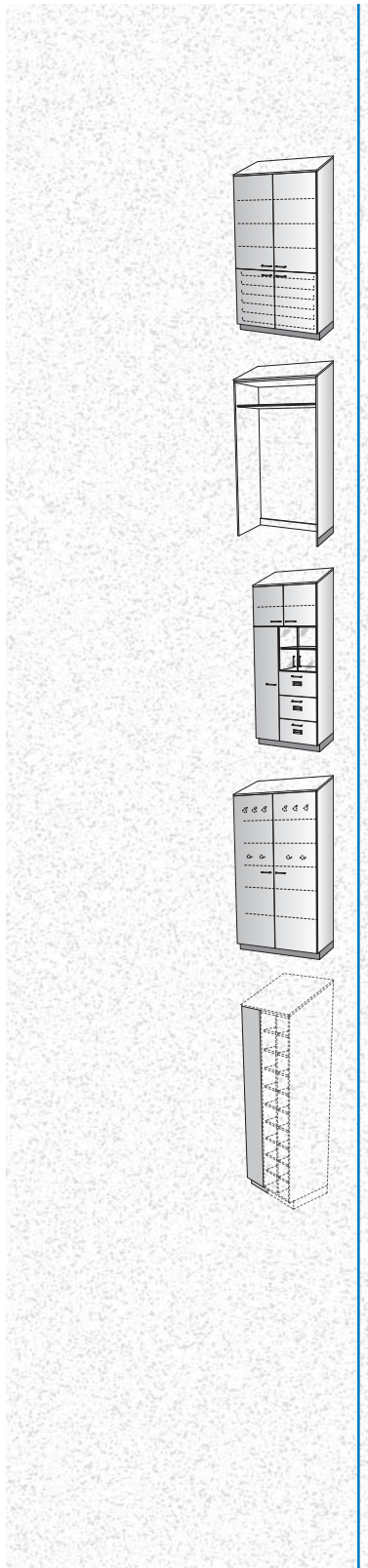

Table of Contents *(continued)*

SLOPE TALL



Rollout Shelf39

Open Bottom39

Media Integration40

Utility Storage40



Installation Accessories41-42

Design Details.....43

SLOPE TALL

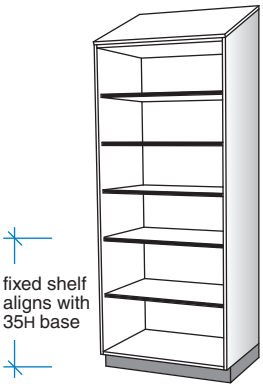

Slope top units require 26816 slope top cover panel for field installation.
Height (H) denotes cabinet box height plus toe kick.

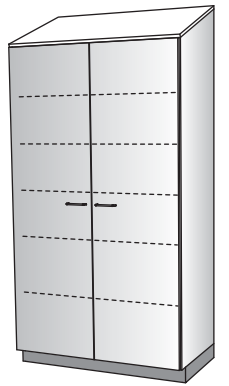
Shelf				
	<p>W: 12,15,18,21,24,27,30,33,36,39,42,45,48</p> <p>H: 84</p> <p>D: 14,18,21,24</p> <p>Adjustable Shelves Fixed Shelf</p>	<p>W: 12,15,18,21,24</p> <p>H: 84</p> <p>D: 14,18,21,24</p> <p>Right Hinge Door Adjustable Shelves Fixed Shelf</p>	<p>W: 12,15,18,21,24</p> <p>H: 84</p> <p>D: 14,18,21,24</p> <p>Left Hinge Door Adjustable Shelves Fixed Shelf</p>	<p>W: 24,27,30,33,36,39,42,45,48</p> <p>H: 84</p> <p>D: 14,18,21,24</p> <p>Doors Adjustable Shelves Fixed Shelf</p>
	26101	26120	26121	26129
84H	 <p>fixed shelf aligns with 35H base</p>			

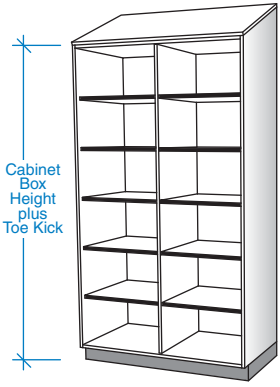

Shelf	
<p>W: 30,33,36,39,42,45,48</p> <p>H: 84</p> <p>D: 14,18,21,24</p> <p>Center Divider Adjustable Shelves</p>	<p>W: 30,33,36,39,42,45,48</p> <p>H: 84</p> <p>D: 14,18,21,24</p> <p>Doors Center Divider Adjustable Shelves</p>
26138	26181
84H	 <p>Cabinet Box Height plus Toe Kick</p>

SLOPE TALL





Shelf



Slope top units require 26816 slope top cover panel for field installation.
Height (H) denotes cabinet box height plus toe kick.

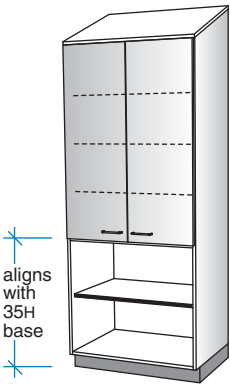

Shelf			
	<p>W: 12,15,18,21,24 H: 84 D: 14,18,21,24</p> <p>Right Hinge Upper/Lower Doors Adjustable Shelves</p>	<p>W: 12,15,18,21,24 H: 84 D: 14,18,21,24</p> <p>Left Hinge Upper/Lower Doors Adjustable Shelves</p>	<p>W: 30,33,36,39,42,45,48 H: 84 D: 14,18,21,24</p> <p>Upper/Lower Doors Adjustable Shelves</p>
	26116	26117	26127
84H			

Slope top units require 26816 slope top cover panel for field installation.
Height (H) denotes cabinet box height plus toe kick.

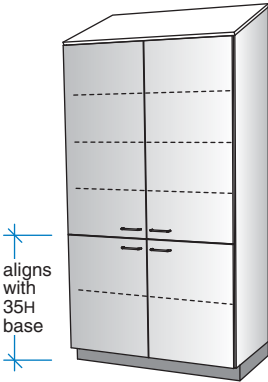
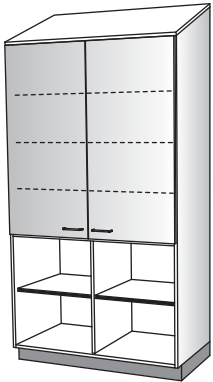
Shelf				
	<p>W: 24,27,30,33,36 H: 84 D: 14,18,21,24</p> <p>Upper Doors Adjustable Shelves</p>	<p>W: 24,27,30,33,36 H: 84 D: 14,18,21,24</p> <p>Adjustable Shelves Lower Doors</p>	<p>W: 12,15,18,21,24 H: 84 D: 14,18,21,24</p> <p>Right Hinge Upper/Lower Doors Adjustable Shelves</p>	<p>W: 12,15,18,21,24 H: 84 D: 14,18,21,24</p> <p>Left Hinge Upper/Lower Doors Adjustable Shelves</p>
	26125	26128	26118	26119
84H	 <p>aligns with 35H base</p>			

Shelf				
	<p>W: 24,27,30,33,36,39,42,45,48 H: 84 D: 14,18,21,24</p> <p>Upper/Lower Doors Adjustable Shelves</p>	<p>W: 39,42,45,48 H: 84 D: 14,18,21,24</p> <p>Upper Doors Lower Center Divider Adjustable Shelves</p>	<p>W: 39,42,45,48 H: 84 D: 14,18,21,24</p> <p>Upper/Lower Doors Lower Center Divider Adjustable Shelves</p>	<p>W: 36,39,42,45,48 H: 84 D: 18,21,24</p> <p>Upper/Lower Sliding Doors Center Dividers Adjustable Shelves</p>
	26126	26123	26124	26150
84H	 <p>aligns with 35H base</p>			

SLOPE TALL

Display

Slope top units require 26816 slope top cover panel for field installation.
Height (H) denotes cabinet box height plus toe kick.









Display			
	W: 15,18,21,24 H: 84 D: 14,18,21,24 Right Hinge Display Door Adjustable Shelves	W: 15,18,21,24 H: 84 D: 14,18,21,24 Left Hinge Display Door Adjustable Shelves	W: 30,36,42,48 H: 84 D: 14,18,21,24 Display Doors Center Divider Adjustable Shelves
	26132	26133	26140
84H			

Display				
	W: 15,18,21,24 H: 84 D: 14,18,21,24 Right Hinge Display Door Adjustable Shelves	W: 15,18,21,24 H: 84 D: 14,18,21,24 Left Hinge Display Door Adjustable Shelves	W: 36 H: 84 D: 14,18,21,24 Display Doors Adjustable Shelves	W: 30,36,42,48 H: 84 D: 14,18,21,24 Display Doors Center Divider Adjustable Shelves
	26130	26131	26134	26137
84H				

Display / Expanded Metal Door

Slope top units require 26816 slope top cover panel for field installation.
Height (H) denotes cabinet box height plus toe kick.

Display				
	<p>W: 36,42,48 H: 84 D: 18,21,24</p> <p>Upper Display Doors Lower Doors Fixed Shelf Adjustable Shelves</p>	<p>W: 36,42,48 H: 84 D: 18,21,24</p> <p>Upper Sliding Display Doors Lower Sliding Doors Center Dividers Adjustable Shelves</p>	<p>W: 36,42,48 H: 84 D: 18,21,24</p> <p>Upper/Lower Sliding Display Doors Center Dividers Adjustable Shelves</p>	<p>W: 36,39,42,45,48 H: 84 D: 14,18,21,24</p> <p>Upper Sliding Glass Doors Lower Doors Center Dividers Adjustable Shelves</p>
	26135	26154	26155	26158
84H	 <p>aligns with 35H base</p>			

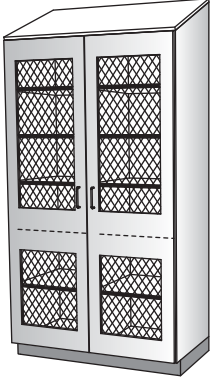
Expanded Metal Door				
	<p>W: 15,18,21,24 H: 84 D: 14,18,21,24</p> <p>Right Hinge Framed Expanded Metal Door Adjustable Shelves Expanded Metal Available in Black, White, Grey (color linked to accent color option)</p>	<p>W: 15,18,21,24 H: 84 D: 14,18,21,24</p> <p>Left Hinge Framed Expanded Metal Door Adjustable Shelves Expanded Metal Available in Black, White, Grey (color linked to accent color option)</p>	<p>W: 30,36 H: 84 D: 14,18,21,24</p> <p>Framed Expanded Metal Doors Adjustable Shelves Expanded Metal Available in Black, White, Grey (color linked to accent color option)</p>	<p>W: 30,36,42,48 H: 84 D: 14,18,21,24</p> <p>Framed Expanded Metal Doors Center Divider Adjustable Shelves Expanded Metal Available in Black, White, Grey (color linked to accent color option)</p>
	26106	26107	26108	26109
84H	 <p>aligns with 35H base</p>			

SLOPE TALL

Corner

Slope top units require 26816 slope top cover panel for field installation.
Height (H) denotes cabinet box height plus toe kick.



Corner – Blind

14" DEEP:

W: 33,36

H: 84

D: 14

18" DEEP:

W: 36,39

H: 84

D: 18

21" DEEP:

W: 36,39,42

H: 84

D: 21

24" DEEP:

W: 42,45,48

H: 84

D: 24

Right Hinge Door
Fixed Shelf
Adjustable Shelves

14" DEEP:

W: 33,36

H: 84

D: 14

18" DEEP:

W: 36,39

H: 84

D: 18

21" DEEP:

W: 36,39,42

H: 84

D: 21

24" DEEP:

W: 42,45,48

H: 84

D: 24

Left Hinge Door
Fixed Shelf
Adjustable Shelves

26200

26201



84H

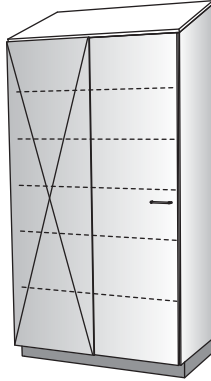
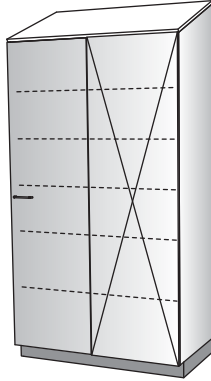



fixed shelf
aligns with
35H base



Cubicle

Slope top units require 26816 slope top cover panel for field installation.
Height (H) denotes cabinet box height plus toe kick.

Cubicle			
<p>Compt. Widths 18W = 7⁷/₈" 24W = 10⁷/₈"</p>	<p>W: 18,24 H: 84 D: 14,18,21,24</p> <p>3/4" Adjustable Cubicle Shelves Compartment Spacing 3"H min.</p>	<p>W: 18,24 H: 84 D: 14,18,21,24</p> <p>Right Hinge Door 3/4" Adjustable Cubicle Shelves Compartment Spacing 3"H min.</p>	<p>W: 18,24 H: 84 D: 14,18,21,24</p> <p>Left Hinge Door 3/4" Adjustable Cubicle Shelves Compartment Spacing 3"H min.</p>
	26220	26222	26223
<p>84H 20 Compts.</p>			

Cubicle				
<p>Compt. Widths 30W = 9" 36W = 11" 42W = 13" 48W = 15"</p>	<p>W: 30,36,42,48 H: 84 D: 14,18,21,24</p> <p>3/4" Adjustable Cubicle Shelves Compartment Spacing 3"H min.</p>	<p>W: 30,36,42,48 H: 84 D: 14,18,21,24</p> <p>Doors 3/4" Adjustable Cubicle Shelves Compartment Spacing 3"H min.</p>	<p>Compt. Widths 36W = 8" 42W = 9¹/₂" 48W = 11"</p> <p>W: 36,42,48 H: 84 D: 14,18,21,24</p> <p>3/4" Adjustable Cubicle Shelves Compartment Spacing 3"H min.</p>	
	26226	26227	26239	26240
<p>84H 30 Compts.</p>				

SLOPE TALL

Cubicle

Slope top units require 26816 slope top cover panel for field installation.
Height (H) denotes cabinet box height plus toe kick.





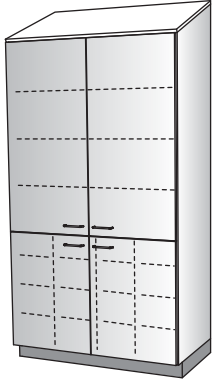
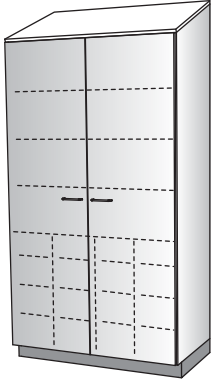

Cubicle		Cubicle		Cubicle		Cubicle	
Compt. Widths 30W = 9" 36W = 11"	W: 30,36 H: 84 D: 14,18,21,24 Adjustable Shelves 3/4" Adjustable Cubicle Shelves Compartment Spacing 3"H min.	W: 30,36 H: 84 D: 14,18,21,24 Adjustable Shelves Lower Doors 3/4" Adjustable Cubicle Shelves Compartment Spacing 3"H min.	Compt. Widths 30W = 9" 36W = 11" 42W = 13" 48W = 15"	W: 30,36,42,48 H: 84 D: 14,18,21,24 Upper/Lower Doors Adjustable Shelves 3/4" Adjustable Cubicle Shelves Compartment Spacing 3"H min.	W: 30,36,42,48 H: 84 D: 14,18,21,24 Doors Adjustable Shelves 3/4" Adjustable Cubicle Shelves Compartment Spacing 3"H min.		
	26229	26230		26231	26232		
84H 12 Compts.							
aligns with 35H base							

Cubicle		Cubicle		Cubicle		Cubicle	
Compt. Widths 42W = 13" 48W = 15"	W: 42,48 H: 84 D: 14,18,21,24 Center Divider Adjustable Shelves 3/4" Adjustable Cubicle Shelves Compartment Spacing 3"H min.	W: 42,48 H: 84 D: 14,18,21,24 Center Divider Adjustable Shelves Lower Doors 3/4" Adjustable Cubicle Shelves Compartment Spacing 3"H min.	Compt. Widths 30W = 9" 36W = 11" 42W = 13" 48W = 15"	W: 30,36,42,48 H: 84 D: 14,18,21,24 Upper/Lower Doors Center Divider Adjustable Shelves 3/4" Adjustable Cubicle Shelves Compartment Spacing 3"H min.	W: 30,36,42,48 H: 84 D: 14,18,21,24 Doors Center Divider Adjustable Shelves 3/4" Adjustable Cubicle Shelves Compartment Spacing 3"H min.		
	26233	26234		26235	26236		
84H 12 Compts.							
aligns with 35H base							

Slope top units require 26816 slope top cover panel for field installation.
Height (H) denotes cabinet box height plus toe kick.

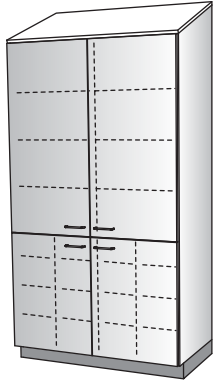
Cubicle	
Compt. Widths 36W = 8" 42W = 9½" 48W = 11"	W: 36,42,48 H: 84 D: 14,18,21,24 Upper/Lower Doors Adjustable Shelves ¾" Adjustable Cubicle Shelves Compartment Spacing 3"H min.
	W: 36,42,48 H: 84 D: 14,18,21,24 Doors Adjustable Shelves ¾" Adjustable Cubicle Shelves Compartment Spacing 3"H min.
	26246
	26247
84H 16 Compts.	 
	aligns with 35H base

Cubicle			
Compt. Widths 36W = 8" 42W = 9½" 48W = 11"	W: 36,42,48 H: 84 D: 14,18,21,24 Center Divider Adjustable Shelves ¾" Adjustable Cubicle Shelves Compartment Spacing 3"H min.	W: 36,42,48 H: 84 D: 14,18,21,24 Center Divider Adjustable Shelves Lower Doors ¾" Adjustable Cubicle Shelves Compartment Spacing 3"H min.	W: 36,42,48 H: 84 D: 14,18,21,24 Upper/Lower Doors Center Divider Adjustable Shelves ¾" Adjustable Cubicle Shelves Compartment Spacing 3"H min.
	W: 36,42,48 H: 84 D: 14,18,21,24 Doors Center Divider Adjustable Shelves ¾" Adjustable Cubicle Shelves Compartment Spacing 3"H min.		
	26248	26249	26250
	26251		
84H 16 Compts.	   		
	aligns with 35H base		

SLOPE TALL

Bin Storage

Slope top units require 26816 slope top cover panel for field installation.
Height (H) denotes cabinet box height plus toe kick.



SA910: 12¹/₄W x 3H x 16³/₄D



SA911: 12¹/₄W x 6H x 16³/₄D



Bin Storage

W: 42
H: 84
D: 21,24
Molded Translucent Bins

W: 42
H: 84
D: 21,24
Doors
Molded Translucent Bins

W: 42
H: 84
D: 21,24
Molded Translucent Bins

W: 42
H: 84
D: 21,24
Doors
Molded Translucent Bins

26242

26243

26244

26245

84H
(48) SA910 Bins

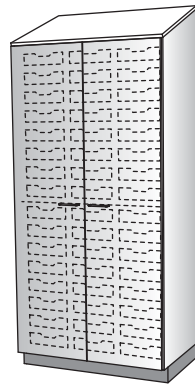
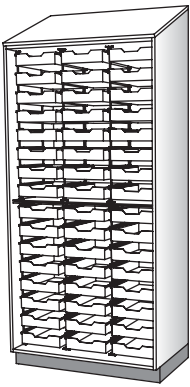

84H
(24) SA911 Bins

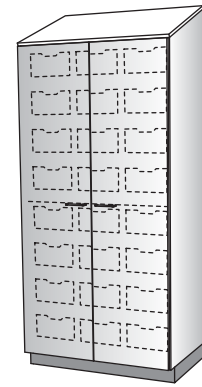

Bin Storage

W: 42
H: 84
D: 21,24
Center Divider
Adjustable Shelves
Molded Translucent Bins

W: 42
H: 84
D: 21,24
Center Divider
Adjustable Shelves
Lower Doors
Molded Translucent Bins

W: 42
H: 84
D: 21,24
Upper/Lower Doors
Center Divider
Adjustable Shelves
Molded Translucent Bins

26311

26312

26313

84H
(18) SA910 Bins

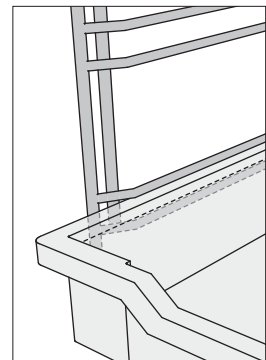
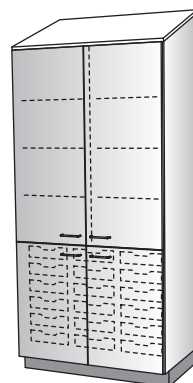
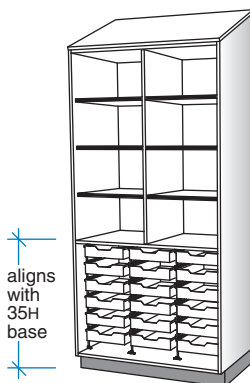

Bin and tray racks have captured runner rail to reduce tray tipout.



Tray Storage

Slope top units require 26816 slope top cover panel for field installation.

Height (H) denotes cabinet box height plus toe kick.

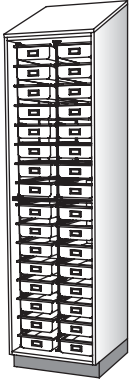
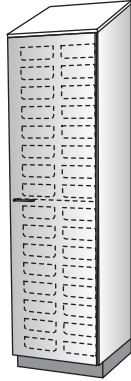
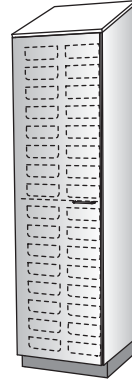
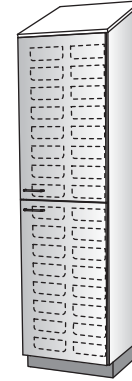

SA902: 10W x 3 1/2H x 19D

Tray Storage				
<p>W: 24 H: 84 D: 24</p> <p>Molded Trays with Card Holder</p>	<p>W: 24 H: 84 D: 24</p> <p>Right Hinge Door Molded Trays with Card Holder</p>	<p>W: 24 H: 84 D: 24</p> <p>Left Hinge Door Molded Trays with Card Holder</p>	<p>W: 24 H: 84 D: 24</p> <p>Right Hinge Upper/Lower Doors Molded Trays with Card Holder</p>	<p>W: 24 H: 84 D: 24</p> <p>Left Hinge Upper/Lower Doors Molded Trays with Card Holder</p>
26263	26264	26265	26266	26267
<p>84H (32) SA902 Trays</p>				
				

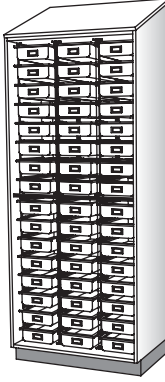
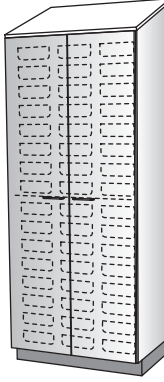
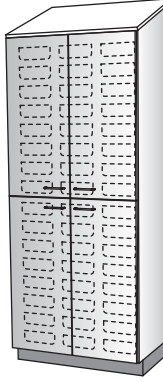
Tray Storage		
<p>W: 36 H: 84 D: 24</p> <p>Molded Trays with Card Holder</p>	<p>W: 36 H: 84 D: 24</p> <p>Doors Molded Trays with Card Holder</p>	<p>W: 36 H: 84 D: 24</p> <p>Upper/Lower Doors Molded Trays with Card Holder</p>
26270	26271	26287
<p>84H (48) SA902 Trays</p>		
		

SLOPE TALL

Tray Storage

Slope top units require 26816 slope top cover panel for field installation.
Height (H) denotes cabinet box height plus toe kick.



SA901: 14 1/4W x 3 1/2H x 19D



SA902: 10W x 3 1/2H x 19D



Tray Storage

W: 48
H: 84
D: 24

Molded Trays with Card Holder

W: 48
H: 84
D: 24

Doors
Molded Trays with Card Holder

W: 48
H: 84
D: 24

Upper/Lower Doors
Molded Trays with Card Holder

26274

26275

26288

84H
(48) SA901
Trays

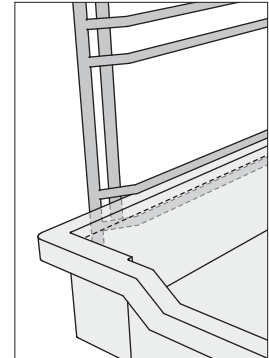
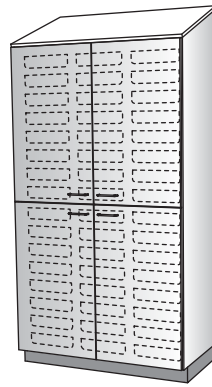
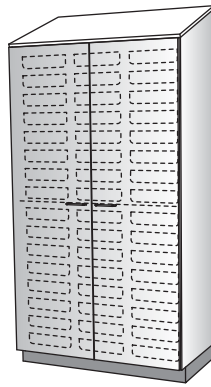

Bin and tray racks have captured runner rail to reduce tray tipout.

Tray Storage

W: 48
H: 84
D: 24

Molded Trays with Card Holder

W: 48
H: 84
D: 24

Doors
Molded Trays with Card Holder

W: 48
H: 84
D: 24

Upper/Lower Doors
Molded Trays with Card Holder

26281

26282

26289

84H
(64) SA902
Trays

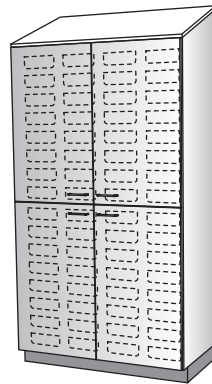
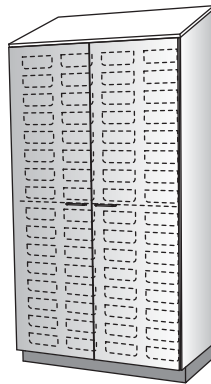
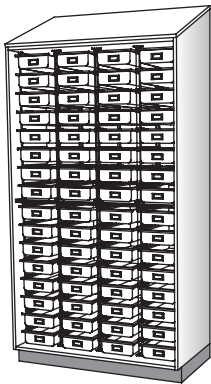





Tray Storage



Slope top units require 26816 slope top cover panel for field installation.

Height (H) denotes cabinet box height plus toe kick.



SA902: 10W x 3 1/2H x 19D

Tray Storage					
	<p>W: 24 H: 84 D: 24</p> <p>Adjustable Shelves Molded Trays with Card Holder</p>	<p>W: 24 H: 84 D: 24</p> <p>Adjustable Shelves Lower Right Hinge Door Molded Trays with Card Holder</p>	<p>W: 24 H: 84 D: 24</p> <p>Adjustable Shelves Lower Left Hinge Door Molded Trays with Card Holder</p>	<p>W: 24 H: 84 D: 24</p> <p>Upper/Lower Right Hinge Doors Adjustable Shelves Molded Trays with Card Holder</p>	<p>W: 24 H: 84 D: 24</p> <p>Upper/Lower Left Hinge Doors Adjustable Shelves Molded Trays with Card Holder</p>
	26290	26291	26292	26293	26294
<p>84H (12) SA902 Trays</p> <p>aligns with 35H base</p>					

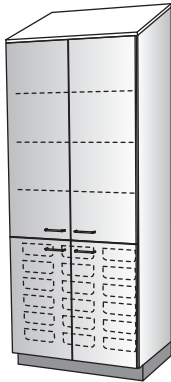
Tray Storage			
<p>W: 36 H: 84 D: 24</p> <p>Adjustable Shelves Molded Trays with Card Holder</p>	<p>W: 36 H: 84 D: 24</p> <p>Adjustable Shelves Lower Doors Molded Trays with Card Holder</p>	<p>W: 36 H: 84 D: 24</p> <p>Upper/Lower Doors Adjustable Shelves Molded Trays with Card Holder</p>	
26300	26301	26302	
<p>84H (18) SA902 Trays</p> <p>aligns with 35H base</p>			

SLOPE TALL

Tray Storage

Slope top units require 26816 slope top cover panel for field installation.
Height (H) denotes cabinet box height plus toe kick.



SA901: 14 1/4W x 3 1/2H x 19D



SA902: 10W x 3 1/2H x 19D



Tray Storage

W: 48
H: 84
D: 24

Center Divider
Adjustable Shelves
Molded Trays with Card Holder

26303



aligns with 35H base

W: 48
H: 84
D: 24

Center Divider
Adjustable Shelves
Lower Doors
Molded Trays with Card Holder

26305



W: 48
H: 84
D: 24

Upper/Lower Doors
Adjustable Shelves
Molded Trays with Card Holder

26306

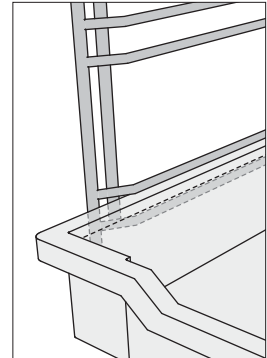
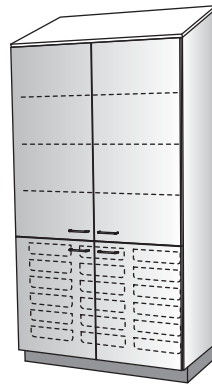

Bin and tray racks have captured runner rail to reduce tray tipout.

84H
(18) SA901
Trays

Tray Storage

W: 48
H: 84
D: 24

Center Divider
Adjustable Shelves
Molded Trays with Card Holder

26308



aligns with 35H base

W: 48
H: 84
D: 24

Center Divider
Adjustable Shelves
Lower Doors
Molded Trays with Card Holder

26309



W: 48
H: 84
D: 24

Upper/Lower Doors
Adjustable Shelves
Molded Trays with Card Holder

26310

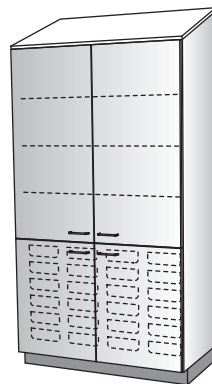

84H
(24) SA902
Trays



Tray Storage

Slope top units require 26816 slope top cover panel for field installation.

Height (H) denotes cabinet box height plus toe kick.

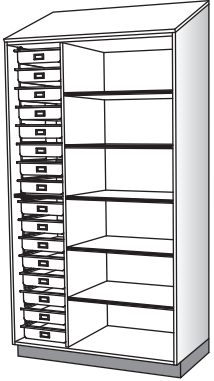

SA901: 14 1/4W x 3 1/2H x 19D

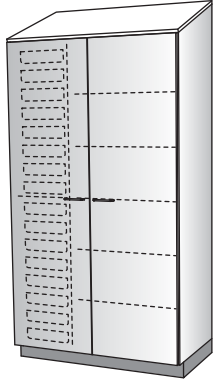
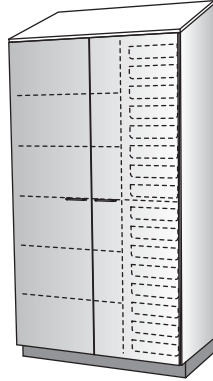
Tray Storage				
	<p>W: 36,42,48 H: 84 D: 24</p> <p>Left: Molded Trays with Card Holder Right: Adjustable Shelves</p>	<p>W: 36,42,48 H: 84 D: 24</p> <p>Left: Adjustable Shelves Right: Molded Trays with Card Holder</p>	<p>W: 36,42,48 H: 84 D: 24</p> <p>Doors Left: Molded Trays with Card Holder Right: Adjustable Shelves</p>	<p>W: 36,42,48 H: 84 D: 24</p> <p>Doors Left: Adjustable Shelves Right: Molded Trays with Card Holder</p>
	26598	26599	26600	26601
<p>84H (16) SA901 Trays</p>				

SLOPE TALL

Folder

Slope top units require 26816 slope top cover panel for field installation.
Height (H) denotes cabinet box height plus toe kick.



Folder					
Compt. Widths 15W = 13 1/2" 18W = 16 1/2" 21W = 19 1/2" 24W = 22 1/2"	W: 15,18,21,24 H: 84 D: 18,21,24 1/4" Folder Shelves, Adjustable and Removable on 1 1/4" Centers	W: 15,18,21,24 H: 84 D: 18,21,24 Right Hinge Door 1/4" Folder Shelves, Adjustable and Removable on 1 1/4" Centers	W: 15,18,21,24 H: 84 D: 18,21,24 Left Hinge Door 1/4" Folder Shelves, Adjustable and Removable on 1 1/4" Centers	Compt. Widths 30W = 13 7/8" 36W = 16 7/8" 42W = 19 7/8" 48W = 22 7/8"	W: 30,36,42,48 H: 84 D: 18,21,24 1/4" Folder Shelves, Adjustable and Removable on 1 1/4" Centers
	W: 30,36,42,48 H: 84 D: 18,21,24 Doors 1/4" Folder Shelves, Adjustable and Removable on 1 1/4" Centers				
	26641	26642	26643		26645
84H 31 Compts. 2 1/4"H min.					
84H 62 Compts. 2 1/4"H min.					

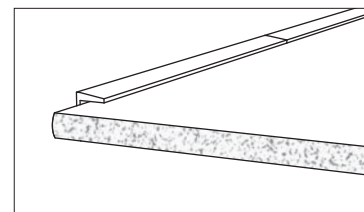

Folder	
Compt. Widths 30W = 9" 36W = 11" 42W = 13" 48W = 15"	W: 30,36,42,48 H: 84 D: 18,21,24 1/4" Folder Shelves, Adjustable and Removable on 1 1/4" Centers
	W: 30,36,42,48 H: 84 D: 18,21,24 Doors 1/4" Folder Shelves, Adjustable and Removable on 1 1/4" Centers
26647	26648
84H 93 Compts. 2 1/4"H min.	



1/4"-thick folder shelves are held securely with translucent, low profile shelf supports.
All edges unfinished.
Front edge unfinished and shaped.

File Drawer



Slope top units require 26816 slope top cover panel for field installation.
Height (H) denotes cabinet box height plus toe kick.
File drawer units align with 2-, 3- and 4-drawer base file units.
File units must be securely anchored.

File Drawer			
<p>W: 15,18 H: 84 D: 18,21,24</p> <p>Adjustable Shelves 3 Full Extension File Drawers 15W: Letter File Drawers 18W: Legal File Drawers</p>	<p>W: 15,18 H: 84 D: 18,21,24</p> <p>Right Hinge Door Adjustable Shelves 3 Full Extension File Drawers 15W: Letter File Drawers 18W: Legal File Drawers</p>	<p>W: 15,18 H: 84 D: 18,21,24</p> <p>Left Hinge Door Adjustable Shelves 3 Full Extension File Drawers 15W: Letter File Drawers 18W: Legal File Drawers</p>	
26326	26327	26328	
84H			

Letter and legal file drawers are designed for front-to-back filing. Optional crossbars allow side filing.

Lateral file drawers are designed for side filing. Optional file bars allow front-to-back filing.

See Installation Accessories.

File Drawer			
<p>W: 15,18 H: 84 D: 18,21,24</p> <p>Adjustable Shelf 4 Full Extension File Drawers 15W: Letter File Drawers 18W: Legal File Drawers</p>	<p>W: 15,18 H: 84 D: 18,21,24</p> <p>Right Hinge Door Adjustable Shelf 4 Full Extension File Drawers 15W: Letter File Drawers 18W: Legal File Drawers</p>	<p>W: 15,18 H: 84 D: 18,21,24</p> <p>Left Hinge Door Adjustable Shelf 4 Full Extension File Drawers 15W: Letter File Drawers 18W: Legal File Drawers</p>	
26329	26330	26331	
84H			

SLOPE TALL

File Drawer

Slope top units require 26816 slope top cover panel for field installation.
 Height (H) denotes cabinet box height plus toe kick.
 File drawer units align with 2-, 3- and 4-drawer base file units.
 File units must be securely anchored.



File Drawer				
	<p>W: 30,36 H: 84 D: 18,21,24</p> <p>Adjustable Shelves 6 Full Extension File Drawers 30W: Letter File Drawers 36W: Legal File Drawers</p>	<p>W: 30,36 H: 84 D: 18,21,24</p> <p>Doors Adjustable Shelves 6 Full Extension File Drawers 30W: Letter File Drawers 36W: Legal File Drawers</p>	<p>W: 30,36 H: 84 D: 21,24</p> <p>Adjustable Shelves 3 Full Extension Lateral File Drawers with Dividers for Side Filing of Letter/Legal Files Drawer Box Depth=440mm</p>	<p>W: 30,36 H: 84 D: 21,24</p> <p>Doors Adjustable Shelves 3 Full Extension Lateral File Drawers with Dividers for Side Filing of Letter/Legal Files Drawer Box Depth=440mm</p>
	26320	26321	26322	26323
84H				

File Drawer	
<p>W: 30,36 H: 84 D: 21,24</p> <p>Adjustable Shelves 2 Full Extension Lateral File Drawers with Dividers for Side Filing of Letter/Legal Files Drawer Box Depth=440mm</p>	<p>W: 30,36 H: 84 D: 21,24</p> <p>Doors Adjustable Shelves 2 Full Extension Lateral File Drawers with Dividers for Side Filing of Letter/Legal Files Drawer Box Depth=440mm</p>
26324	26325
84H	





Letter and legal file drawers are designed for front-to-back filing. Optional crossbars allow side filing.

Lateral file drawers are designed for side filing. Optional file bars allow front-to-back filing.



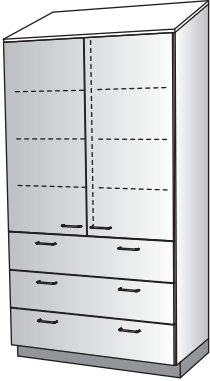

See Installation Accessories.

Combination Storage

Slope top units require 26816 slope top cover panel for field installation.
Height (H) denotes cabinet box height plus toe kick.

Combination Storage					
	<p>W: 24,27,30,33,36 H: 84 D: 18,21,24</p> <p>Adjustable Shelves 3 Equal Drawers</p>	<p>W: 24,27,30,33,36 H: 84 D: 18,21,24</p> <p>Doors Adjustable Shelves 3 Equal Drawers</p>	<p>W: 39,42,45,48 H: 84 D: 18,21,24</p> <p>Doors Adjustable Shelves 3 Equal Drawers</p>	<p>W: 39,42,45,48 H: 84 D: 18,21,24</p> <p>Center Divider Adjustable Shelves 3 Equal Drawers</p>	<p>W: 39,42,45,48 H: 84 D: 18,21,24</p> <p>Doors Center Divider Adjustable Shelves 3 Equal Drawers</p>
	26332	26336	26337	26334	26335
84H					

aligns with 35H base

Combination Storage				
	<p>W: 30,36 H: 84 D: 18,21,24</p> <p>Display Doors Adjustable Shelves 3 Equal Drawers</p>	<p>W: 42,48 H: 84 D: 18,21,24</p> <p>Display Doors Center Divider Adjustable Shelves 3 Equal Drawers</p>	<p>W: 42,48 H: 84 D: 18,21,24</p> <p>Sliding Display Doors Center Divider Adjustable Shelves 3 Equal Drawers</p>	<p>W: 39,42,45,48 H: 84 D: 18,21,24</p> <p>Sliding Glass Doors Center Divider Adjustable Shelves 3 Equal Drawers</p>
	26338	26339	26342	26343
84H				

aligns with 35H base

SLOPE TALL

Combination Storage

Slope top units require 26816 slope top cover panel for field installation.
Height (H) denotes cabinet box height plus toe kick.



Combination Storage

W: 24,27,30,33,36
H: 84
D: 18,21,24

Adjustable Shelves
4 Equal Drawers

26371



aligns with 35H base

W: 24,27,30,33,36
H: 84
D: 18,21,24

Doors
Adjustable Shelves
4 Equal Drawers

26372



W: 39,42,45,48
H: 84
D: 18,21,24

Doors
Adjustable Shelves
4 Equal Drawers

26375



W: 39,42,45,48
H: 84
D: 18,21,24

Center Divider
Adjustable Shelves
4 Equal Drawers

26373



W: 39,42,45,48
H: 84
D: 18,21,24

Doors
Center Divider
Adjustable Shelves
4 Equal Drawers

26374



84H

Combination Storage

W: 30,36
H: 84
D: 18,21,24

Display Doors
Adjustable Shelves
4 Equal Drawers

26381



aligns with 35H base

W: 42,48
H: 84
D: 18,21,24

Display Doors
Center Divider
Adjustable Shelves
4 Equal Drawers

26379



W: 42,48
H: 84
D: 18,21,24

Sliding Display Doors
Center Divider
Adjustable Shelves
4 Equal Drawers

26378



W: 39,42,45,48
H: 84
D: 18,21,24

Sliding Glass Doors
Center Divider
Adjustable Shelves
4 Equal Drawers





26383







84H

Combination Storage

Slope top units require 26816 slope top cover panel for field installation.
Height (H) denotes cabinet box height plus toe kick.

Combination Storage					
	<p>W: 24,27,30,33,36 H: 84 D: 18,21,24</p> <p>Adjustable Shelves 5 Equal Drawers</p>	<p>W: 24,27,30,33,36 H: 84 D: 18,21,24</p> <p>Doors Adjustable Shelves 5 Equal Drawers</p>	<p>W: 39,42,45,48 H: 84 D: 18,21,24</p> <p>Doors Adjustable Shelves 5 Equal Drawers</p>	<p>W: 39,42,45,48 H: 84 D: 18,21,24</p> <p>Center Divider Adjustable Shelves 5 Equal Drawers</p>	<p>W: 39,42,45,48 H: 84 D: 18,21,24</p> <p>Doors Center Divider Adjustable Shelves 5 Equal Drawers</p>
	26376	26377	26384	26380	26382
84H					

Combination Storage				
	<p>W: 30,36 H: 84 D: 18,21,24</p> <p>Display Doors Adjustable Shelves 5 Equal Drawers</p>	<p>W: 42,48 H: 84 D: 18,21,24</p> <p>Display Doors Center Divider Adjustable Shelves 5 Equal Drawers</p>	<p>W: 42,48 H: 84 D: 18,21,24</p> <p>Sliding Display Doors Center Divider Adjustable Shelves 5 Equal Drawers</p>	<p>W: 39,42,45,48 H: 84 D: 18,21,24</p> <p>Sliding Glass Doors Center Divider Adjustable Shelves 5 Equal Drawers</p>
	26387	26386	26385	26388
84H				

SLOPE TALL

Combination Storage

Slope top units require 26816 slope top cover panel for field installation.
Height (H) denotes cabinet box height plus toe kick.



Combination Storage

W: 18,21,24
H: 84
D: 24

Upper Compartment: Right Hinge Door,
Adjustable Shelves
2 Equal Drawers
Open Lower Compartment: Adjustable Shelf

26173

W: 18,21,24
H: 84
D: 24

Open Upper Compartment: Adjustable Shelves
2 Equal Drawers
Lower Compartment: Right Hinge Door,
Adjustable Shelf

26175

W: 18,21,24
H: 84
D: 24

Upper Compartment: Right Hinge Door,
Adjustable Shelves
2 Equal Drawers
Lower Compartment: Right Hinge Door,
Adjustable Shelf

26177

84H



Combination Storage

W: 18,21,24
H: 84
D: 24

Upper Compartment: Left Hinge Door,
Adjustable Shelves
2 Equal Drawers
Open Lower Compartment: Adjustable Shelf

26174

W: 18,21,24
H: 84
D: 24

Open Upper Compartment: Adjustable Shelves
2 Equal Drawers
Lower Compartment: Left Hinge Door,
Adjustable Shelf

26176

W: 18,21,24
H: 84
D: 24

Upper Compartment: Left Hinge Door,
Adjustable Shelves
2 Equal Drawers
Lower Compartment: Left Hinge Door,
Adjustable Shelf



26178

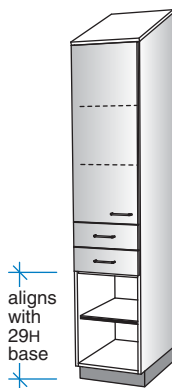

84H



Combination Storage

Slope top units require 26816 slope top cover panel for field installation.
Height (H) denotes cabinet box height plus toe kick.

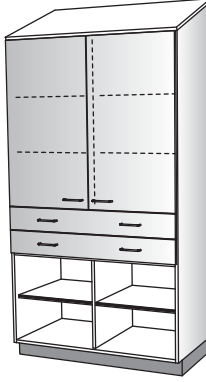
Combination Storage			
	<p>W: 30,33,36 H: 84 D: 24</p> <p>Upper Compartment: Doors, Adjustable Shelves 2 Equal Drawers Open Lower Compartment: Adjustable Shelf</p>	<p>W: 30,33,36 H: 84 D: 24</p> <p>Open Upper Compartment: Adjustable Shelves 2 Equal Drawers Lower Compartment: Doors, Adjustable Shelf</p>	<p>W: 30,33,36 H: 84 D: 24</p> <p>Upper Compartment: Doors, Adjustable Shelves 2 Equal Drawers Lower Compartment: Doors, Adjustable Shelf</p>
	26161	26163	26165
84H	 <p>aligns with 29H base</p>		

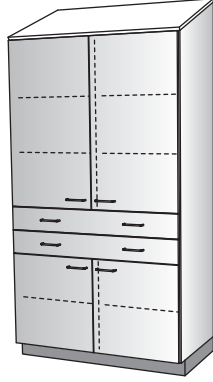
Combination Storage			
	<p>W: 39,42,45,48 H: 84 D: 24</p> <p>Upper Compartment: Doors, Center Divider, Adjustable Shelves 2 Equal Drawers Open Lower Compartment: Center Divider, Adjustable Shelves</p>	<p>W: 39,42,45,48 H: 84 D: 24</p> <p>Open Upper Compartment: Center Divider, Adjustable Shelves 2 Equal Drawers Lower Compartment: Doors, Center Divider, Adjustable Shelves</p>	<p>W: 39,42,45,48 H: 84 D: 24</p> <p>Upper Compartment: Doors, Center Divider, Adjustable Shelves 2 Equal Drawers Lower Compartment: Doors, Center Divider, Adjustable Shelves</p>
	26162	26164	26166
84H	 <p>aligns with 29H base</p>		

SLOPE TALL

Combination Storage

Slope top units require 26816 slope top cover panel for field installation.
Height (H) denotes cabinet box height plus toe kick.



Combination Storage

W: 18,21,24
H: 84
D: 24

Upper Compartment: Right Hinge Door, Adjustable Shelves
2 Equal Drawers
Open Lower Compartment: Adjustable Shelf

26167

W: 18,21,24
H: 84
D: 24

Open Upper Compartment: Adjustable Shelves
2 Equal Drawers
Lower Compartment: Right Hinge Door, Adjustable Shelf

26169

W: 18,21,24
H: 84
D: 24

Upper Compartment: Right Hinge Door, Adjustable Shelves
2 Equal Drawers
Lower Compartment: Right Hinge Door, Adjustable Shelf

26171

84H

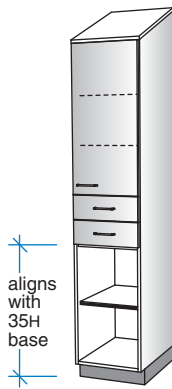

Combination Storage

W: 18,21,24
H: 84
D: 24

Upper Compartment: Left Hinge Door, Adjustable Shelves
2 Equal Drawers
Open Lower Compartment: Adjustable Shelf

26168

W: 18,21,24
H: 84
D: 24

Open Upper Compartment: Adjustable Shelves
2 Equal Drawers
Lower Compartment: Left Hinge Door, Adjustable Shelf

26170

W: 18,21,24
H: 84
D: 24

Upper Compartment: Left Hinge Door, Adjustable Shelves
2 Equal Drawers
Lower Compartment: Left Hinge Door, Adjustable Shelf



26172

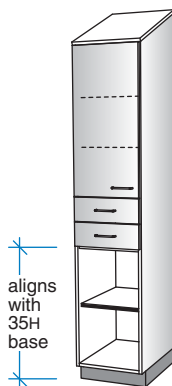

84H

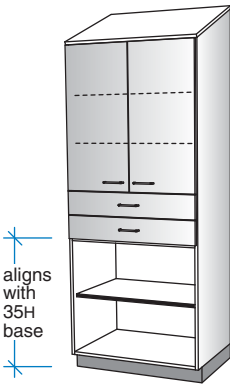

Combination Storage

Slope top units require 26816 slope top cover panel for field installation.
Height (H) denotes cabinet box height plus toe kick.

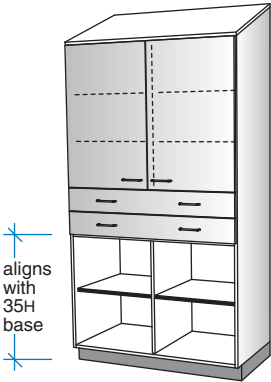
Combination Storage			
	<p>W: 30,33,36 H: 84 D: 24</p> <p>Upper Compartment: Doors, Adjustable Shelves 2 Equal Drawers Open Lower Compartment: Adjustable Shelf</p>	<p>W: 30,33,36 H: 84 D: 24</p> <p>Open Upper Compartment: Adjustable Shelves 2 Equal Drawers Lower Compartment: Doors, Adjustable Shelf</p>	<p>W: 30,33,36 H: 84 D: 24</p> <p>Upper Compartment: Doors, Adjustable Shelves 2 Equal Drawers Lower Compartment: Doors, Adjustable Shelf</p>
	26141	26143	26145
84H	 <p>aligns with 35H base</p>		

Combination Storage			
	<p>W: 39,42,45,48 H: 84 D: 24</p> <p>Upper Compartment: Doors, Center Divider, Adjustable Shelves 2 Equal Drawers Open Lower Compartment: Center Divider, Adjustable Shelves</p>	<p>W: 39,42,45,48 H: 84 D: 24</p> <p>Open Upper Compartment: Center Divider, Adjustable Shelves 2 Equal Drawers Lower Compartment: Doors, Center Divider, Adjustable Shelves</p>	<p>W: 39,42,45,48 H: 84 D: 24</p> <p>Upper Compartment: Doors, Center Divider, Adjustable Shelves 2 Equal Drawers Lower Compartment: Doors, Center Divider, Adjustable Shelves</p>
	26142	26144	26146
84H	 <p>aligns with 35H base</p>		

SLOPE TALL

Wardrobe

Slope top units require 26816 slope top cover panel for field installation.
Height (H) denotes cabinet box height plus toe kick.



Wardrobe

W: 15,18,21,24,27,30,33,36
H: 84
D: 24

Adjustable Shelf, Factory Located
Hanger Bar

W: 15,18,21,24
H: 84
D: 24

Right Hinge Door
Adjustable Shelf, Factory Located
Hanger Bar

W: 15,18,21,24
H: 84
D: 24

Left Hinge Door
Adjustable Shelf, Factory Located
Hanger Bar

W: 30,33,36,39,42,45,48
H: 84
D: 24

Doors
Adjustable Shelf, Factory Located
Hanger Bar

26542

26543

26544

26561

84H

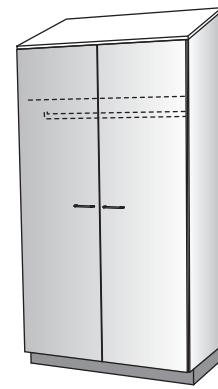
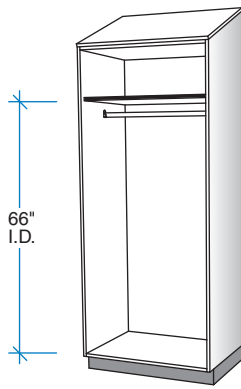

Wardrobe

W: 15,18,21,24,27,30,33,36
H: 84
D: 24

Hanger Bars
Fixed Shelf

W: 15,18,21,24
H: 84
D: 24

Right Hinge Door
Hanger Bars
Fixed Shelf

W: 15,18,21,24
H: 84
D: 24

Left Hinge Door
Hanger Bars
Fixed Shelf

W: 30,33,36,39,42,45,48
H: 84
D: 24

Doors
Hanger Bars
Fixed Shelf

26565

26566

26567

26568

84H



Wardrobe

Slope top units require 26816 slope top cover panel for field installation.
Height (H) denotes cabinet box height plus toe kick.

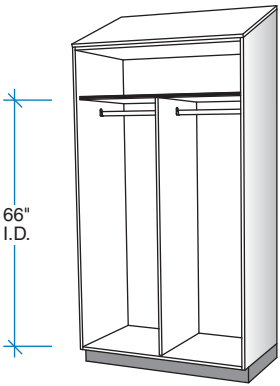
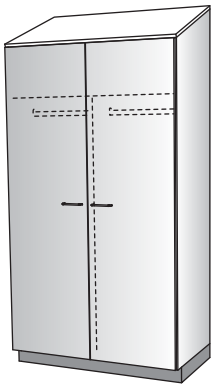
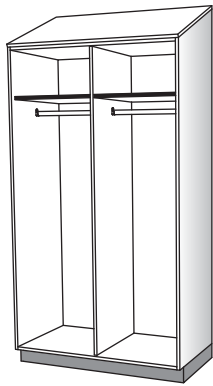
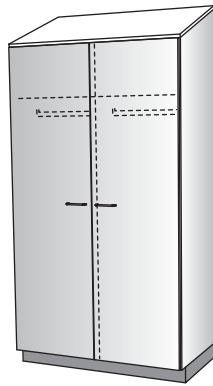
Wardrobe				
	W: 36,39,42,45,48 H: 84 D: 24 Fixed Shelf Center Divider Hanger Bars	W: 36,39,42,45,48 H: 84 D: 24 Doors Fixed Shelf Center Divider Hanger Bars	W: 36,39,42,45,48 H: 84 D: 24 Full Height Center Divider Adjustable Shelves Hanger Bars	W: 36,39,42,45,48 H: 84 D: 24 Doors Full Height Center Divider Adjustable Shelves Hanger Bars
	26557	26558	26560	26571
84H				

SLOPE TALL

Wardrobe / Storage

Slope top units require 26816 slope top cover panel for field installation.
 Height (H) denotes cabinet box height plus toe kick.
 10945 Pin Tray available separately (see Accessories section).



Wardrobe/Storage				
	<p>W: 36 H: 84 D: 24</p> <p>Locked Doors Full Height Center Divider Left: Adjustable Shelf, Wardrobe Hook, Mirror Right: Adjustable Shelves</p>	<p>W: 36 H: 84 D: 24</p> <p>Locked Doors Full Height Center Divider Left: Adjustable Shelves Right: Adjustable Shelf, Wardrobe Hook, Mirror</p>	<p>W: 30,33,36,39 H: 84 D: 24</p> <p>Locked Doors (1/3-2/3 configuration) Full Height Divider Left: Adjustable Shelf, Wardrobe Hook, Mirror Right: Adjustable Shelves</p>	<p>W: 30,33,36,39 H: 84 D: 24</p> <p>Locked Doors (1/3-2/3 configuration) Full Height Divider Left: Adjustable Shelves Right: Adjustable Shelf, Wardrobe Hook, Mirror</p>
	26617	26618	26686	26687
84H				

Wardrobe/Storage				
	<p>W: 30,33,36,39,42,45,48 H: 84 D: 24</p> <p>Locked Doors Fixed Shelf Left: Wardrobe Hook, Mirror Right: Adjustable Shelves</p>	<p>W: 30,33,36,39,42,45,48 H: 84 D: 24</p> <p>Locked Doors Fixed Shelf Left: Adjustable Shelves Right: Wardrobe Hook, Mirror</p>	<p>W: 30,33,36,39,42,45,48 H: 84 D: 24</p> <p>Locked Doors Full Height Divider Left: Adjustable Shelf, Wardrobe Hook, Mirror Right: Adjustable Shelves</p>	<p>W: 30,33,36,39,42,45,48 H: 84 D: 24</p> <p>Locked Doors Full Height Divider Left: Adjustable Shelves Right: Adjustable Shelf, Wardrobe Hook, Mirror</p>
	26602	26604	26603	26605
84H				

Wardrobe / Storage

Slope top units require 26816 slope top cover panel for field installation.
Height (H) denotes cabinet box height plus toe kick.
10945 Pin Tray available separately (see Accessories section).

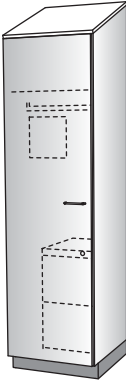
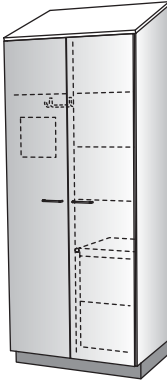
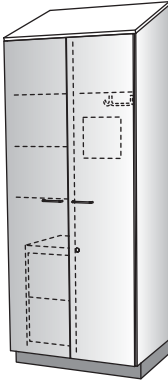
Wardrobe/Storage				
	<p>W: 24 H: 84 D: 24</p> <p>Locked Right Hinge Door Adjustable Shelf Hanger Bar Mirror 2 Full Extension Letter File Drawers</p>	<p>W: 24 H: 84 D: 24</p> <p>Locked Left Hinge Door Adjustable Shelf Hanger Bar Mirror 2 Full Extension Letter File Drawers</p>	<p>W: 36 H: 84 D: 24</p> <p>Locked Doors Full Height Center Divider Left: Adjustable Shelf, Wardrobe Hook, Mirror Right: Adjustable Shelves, 2 Full Extension Letter File Drawers</p>	<p>W: 36 H: 84 D: 24</p> <p>Locked Doors Full Height Center Divider Left: Adjustable Shelves, 2 Full Extension Letter File Drawers Right: Adjustable Shelf, Wardrobe Hook, Mirror</p>
	26672	26673	26667	26668
84H				

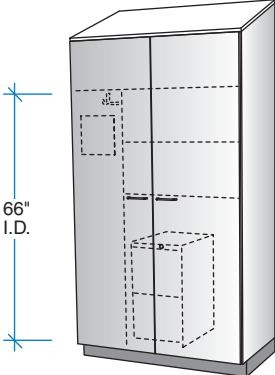
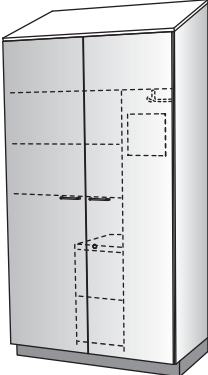
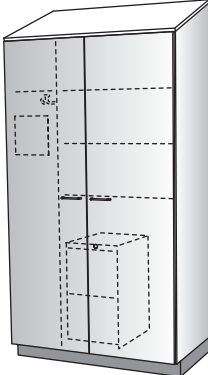
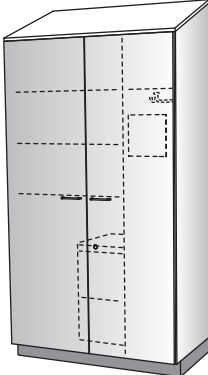
Wardrobe/Storage				
	<p>W: 36,39,42,45,48 H: 84 D: 24</p> <p>Locked Doors Fixed Shelf Left: Wardrobe Hook, Mirror Right: Adjustable Shelves, 2 Full Extension Letter File Drawers</p>	<p>W: 36,39,42,45,48 H: 84 D: 24</p> <p>Locked Doors Fixed Shelf Left: Adjustable Shelves, 2 Full Extension Letter File Drawers Right: Wardrobe Hook, Mirror</p>	<p>W: 36,39,42,45,48 H: 84 D: 24</p> <p>Locked Doors Full Height Divider Left: Adjustable Shelf, Wardrobe Hook, Mirror Right: Adjustable Shelves, 2 Full Extension Letter File Drawers</p>	<p>W: 36,39,42,45,48 H: 84 D: 24</p> <p>Locked Doors Full Height Divider Left: Adjustable Shelves, 2 Full Extension Letter File Drawers Right: Adjustable Shelf, Wardrobe Hook, Mirror</p>
	26609	26610	26606	26607
84H	 <p>66" I.D.</p>			

SLOPE TALL

Wardrobe / Storage

Slope top units require 26816 slope top cover panel for field installation.
 Height (H) denotes cabinet box height plus toe kick.
 10945 Pin Tray available separately (see Accessories section).







Wardrobe/Storage				
	<p>W: 36,39,42,45,48 H: 84 D: 24</p> <p>Locked Doors Full Height Center Divider Left: Adjustable Shelf, Wardrobe Hook, Mirror Right: Adjustable Shelves, 3 Full Extension Letter File Drawers</p>	<p>W: 36,39,42,45,48 H: 84 D: 24</p> <p>Locked Doors Full Height Center Divider Left: Adjustable Shelves, 3 Full Extension Letter File Drawers Right: Adjustable Shelf, Wardrobe Hook, Mirror</p>	<p>W: 36,39,42,45,48 H: 84 D: 24</p> <p>Locked Doors Full Height Divider Left: Adjustable Shelf, Wardrobe Hook, Mirror Right: Adjustable Shelves, 3 Full Extension Letter File Drawers</p>	<p>W: 36,39,42,45,48 H: 84 D: 24</p> <p>Locked Doors Full Height Divider Left: Adjustable Shelves, 3 Full Extension Letter File Drawers Right: Adjustable Shelf, Wardrobe Hook, Mirror</p>
	26669	26670	26614	26615
84H				

Wardrobe/Storage				
	<p>W: 30,33,36,39 H: 84 D: 24</p> <p>Locked Doors (1/3-2/3 configuration) Full Height Divider Left: Adjustable Shelf, Wardrobe Hook, Mirror Right: Adjustable Shelves, 2 Full Extension Letter File Drawers</p>	<p>W: 30,33,36,39 H: 84 D: 24</p> <p>Locked Doors (1/3-2/3 configuration) Full Height Divider Left: Adjustable Shelves, 2 Full Extension Letter File Drawers Right: Adjustable Shelf, Wardrobe Hook, Mirror</p>	<p>W: 33,36,39 H: 84 D: 24</p> <p>Locked Doors (1/3-2/3 configuration) Full Height Divider Left: Adjustable Shelf, Wardrobe Hook, Mirror Right: Adjustable Shelves, 3 Full Extension Letter File Drawers</p>	<p>W: 33,36,39 H: 84 D: 24</p> <p>Locked Doors (1/3-2/3 configuration) Full Height Divider Left: Adjustable Shelves, 3 Full Extension Letter File Drawers Right: Adjustable Shelf, Wardrobe Hook, Mirror</p>
	26678	26679	26688	26689
84H				

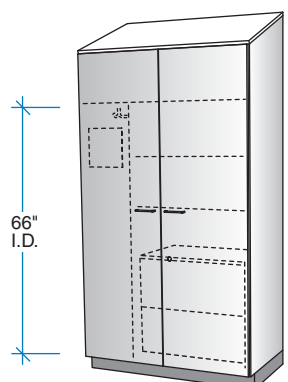
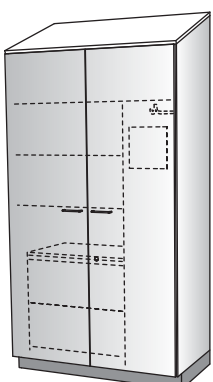
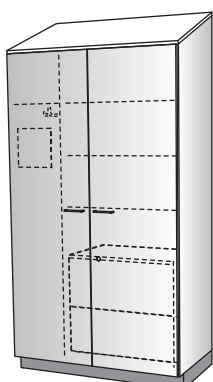
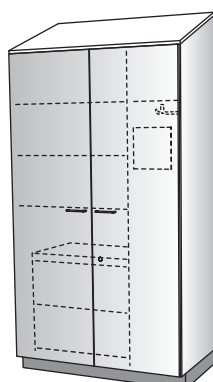
Wardrobe / Storage

Slope top units require 26816 slope top cover panel for field installation.
Height (H) denotes cabinet box height plus toe kick.
10945 Pin Tray available separately (see Accessories section).

Wardrobe/Storage				
	<p>W: 48 H: 84 D: 24</p> <p>Locked Doors Fixed Shelf Left: Wardrobe Hook, Mirror Right: Adjustable Shelves, 2 Full Extension Lateral File Drawers with Divider for Side Filing of Letter/Legal Files</p>	<p>W: 48 H: 84 D: 24</p> <p>Locked Doors Fixed Shelf Left: Adjustable Shelves, 2 Full Extension Lateral File Drawers with Divider for Side Filing of Letter/Legal Files Right: Wardrobe Hook, Mirror</p>	<p>W: 48 H: 84 D: 24</p> <p>Locked Doors Full Height Divider Left: Adjustable Shelf, Wardrobe Hook, Mirror Right: Adjustable Shelves, 2 Full Extension Lateral File Drawers with Divider for Side Filing of Letter/Legal Files</p>	<p>W: 48 H: 84 D: 24</p> <p>Locked Doors Full Height Divider Left: Adjustable Shelves, 2 Full Extension Lateral File Drawers with Divider for Side Filing of Letter/Legal Files Right: Adjustable Shelf, Wardrobe Hook, Mirror</p>
	26655	26656	26665	26666
84H				

Wardrobe/Storage				
	<p>W: 15,18 H: 84 D: 24</p> <p>Wardrobe Compartment with Locked Right Hinge Door, Adjustable Shelf, Wardrobe Hook, Mirror Full Extension Locked Letter File Drawer</p>	<p>W: 15,18 H: 84 D: 24</p> <p>Wardrobe Compartment with Locked Left Hinge Door, Adjustable Shelf, Wardrobe Hook, Mirror Full Extension Locked Letter File Drawer</p>	<p>W: 15,18 H: 84 D: 24</p> <p>Wardrobe Compartment with Locked Right Hinge Door, Adjustable Shelf, Wardrobe Hook, Mirror 2 Full Extension Locked Letter File Drawers</p>	<p>W: 15,18 H: 84 D: 24</p> <p>Wardrobe Compartment with Locked Left Hinge Door, Adjustable Shelf, Wardrobe Hook, Mirror 2 Full Extension Locked Letter File Drawers</p>
	26691	26692	26682	26683
84H				

SLOPE TALL

Wardrobe / Storage

Slope top units require 26816 slope top cover panel for field installation.
 Height (H) denotes cabinet box height plus toe kick.
 10945 Pin Tray available separately (see Accessories section).









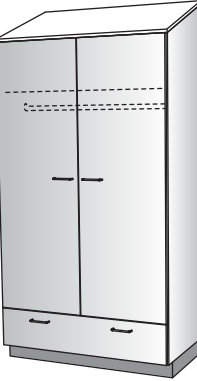
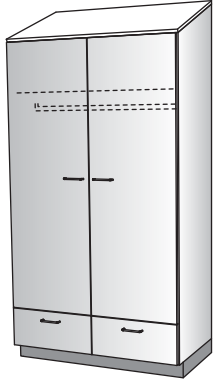
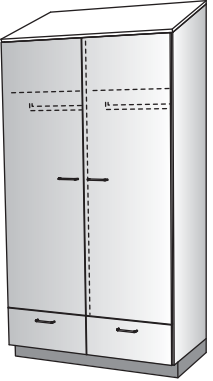

Wardrobe/Storage				
	<p>W: 30,33,36,39 H: 84 D: 24</p> <p>Locked Doors Full Height Divider Left: 2 Full Extension Locked Letter File Drawers, Wardrobe Compartment with Adjustable Shelf, Wardrobe Hook, Mirror Right: Adjustable Shelves</p>	<p>W: 30,33,36,39 H: 84 D: 24</p> <p>Locked Doors Full Height Divider Left: Adjustable Shelves Right: 2 Full Extension Locked Letter File Drawers, Wardrobe Compartment with Adjustable Shelf, Wardrobe Hook, Mirror</p>	<p>W: 30 H: 84 D: 24</p> <p>Locked Doors Full Height Center Divider Left: Adjustable Shelf, Hanger Bar, Mirror Right: 3 Full Extension Locked Letter File Drawers, Storage Compartment with Adjustable Shelves</p>	<p>W: 30 H: 84 D: 24</p> <p>Locked Doors Full Height Center Divider Left: 3 Full Extension Locked Letter File Drawers, Storage Compartment with Adjustable Shelves Right: Adjustable Shelf, Hanger Bar, Mirror</p>
	26684	26685	26657	26653
84H				

Wardrobe/Storage		
	<p>W: 36 H: 84 D: 24</p> <p>Locked Doors Full Height Center Divider Left: Adjustable Shelf, Hanger Bar, Mirror Right: 3 Full Extension Locked Legal File Drawers, Storage Compartment with Adjustable Shelves</p>	<p>W: 36 H: 84 D: 24</p> <p>Locked Doors Full Height Center Divider Left: 3 Full Extension Locked Legal File Drawers, Storage Compartment with Adjustable Shelves Right: Adjustable Shelf, Hanger Bar, Mirror</p>
	26658	26654
84H		

Armoire

Slope top units require 26816 slope top cover panel for field installation.
Height (H) denotes cabinet box height plus toe kick.

Armoire					
	W: 15,18,21,24 H: 84 D: 24 Right Hinge Door Fixed Shelf Hanger Bar Drawer	W: 15,18,21,24 H: 84 D: 24 Left Hinge Door Fixed Shelf Hanger Bar Drawer	W: 30,36,39,42,45,48 H: 84 D: 24 Doors Fixed Shelf Hanger Bar Drawer (30W/36W drawers have single pull)	W: 30,36,39,42,45,48 H: 84 D: 24 Doors Fixed Shelf Hanger Bar 2 Drawers	W: 30,36,39,42,45,48 H: 84 D: 24 Doors Center Divider 2 Fixed Shelves 2 Hanger Bars 2 Drawers
	26573	26574	26576	26579	26578
84H					

Armoire					
	W: 15,18,21,24 H: 84 D: 24 Right Hinge Door Hanger Bar 2 Drawers	W: 15,18,21,24 H: 84 D: 24 Left Hinge Door Hanger Bar 2 Drawers	W: 30,36,39,42,45,48 H: 84 D: 24 Doors Hanger Bar 2 Drawers (30W/36W drawers have single pull)	W: 30,36,39,42,45,48 H: 84 D: 24 Doors Hanger Bar 4 Drawers	W: 30,36,39,42,45,48 H: 84 D: 24 Doors Center Divider 2 Hanger Bars 4 Drawers
	26580	26581	26577	26583	26582
84H					

SLOPE TALL

Display / Trophy

Slope top units require 26816 slope top cover panel for field installation.
 Height (H) denotes cabinet box height plus toe kick.
 Tack Backs, Light Fascias, Light Fixtures, Additional Shelves/Brackets available.
 Must be securely attached to building structure.



Display/Trophy		
<p>W: 36,39,42 H: 84 D: 14,18,21,24</p> <p>Locked Sliding Display Doors with Non-Removable Tempered Glass Ratchet Lock with Key 1/4" Tempered Glass Shelves with Ground Front Edge 2 Heavy Duty Shelf Standards with Brackets (color linked to accent color option) Fixed Lower Front Panel</p>	<p>W: 45,48,54,60 H: 84 D: 14,18,21,24</p> <p>Locked Sliding Display Doors with Non-Removable Tempered Glass Ratchet Lock with Key 1/4" Tempered Glass Shelves with Ground Front Edge 3 Heavy Duty Shelf Standards with Brackets (color linked to accent color option) Fixed Lower Front Panel</p>	<p>W: 36,39,42 H: 84 D: 14,18,21,24</p> <p>Locked Sliding Display Doors with Non-Removable Tempered Glass Color Interior 1/4" Tempered Glass Shelves with Ground Front Edge 2 Heavy Duty Shelf Standards with Brackets (color linked to accent color option) Fixed Lower Front Panel</p>
26780	26781	26782
84H		





Keyed Ratchet Lock for Sliding Glass Display Doors

Display/Trophy		
<p>W: 45,48,54,60 H: 84 D: 14,18,21,24</p> <p>Locked Sliding Display Doors with Non-Removable Tempered Glass Color Interior 1/4" Tempered Glass Shelves with Ground Front Edge 3 Heavy Duty Shelf Standards with Brackets (color linked to accent color option) Fixed Lower Front Panel</p>	<p>W: 36,39,42 H: 84 D: 14,18,21,24</p> <p>Locked Sliding Display Doors with Non-Removable Tempered Glass Color Interior 1/4" Tempered Glass Shelves with Ground Front Edge 2 Heavy Duty Shelf Standards with Brackets (color linked to accent color option) Lower Storage with Locked Doors, Center Divider, Adjustable Shelves</p>	<p>W: 45,48,54,60 H: 84 D: 14,18,21,24</p> <p>Locked Sliding Display Doors with Non-Removable Tempered Glass Color Interior 1/4" Tempered Glass Shelves with Ground Front Edge 3 Heavy Duty Shelf Standards with Brackets (color linked to accent color option) Lower Storage with Locked Doors, Center Divider, Adjustable Shelves</p>
26783	26786	26787
84H		

Rollout Shelf / Open Bottom

Slope top units require 26816 slope top cover panel for field installation.
Height (H) denotes cabinet box height plus toe kick.

Rollout Shelf	
W: 36,42,48 H: 84 D: 24 Adjustable Shelves Lower Doors 6 Full Extension Rollout Shelves	W: 36,42,48 H: 84 D: 24 Upper/Lower Doors Adjustable Shelves 6 Full Extension Rollout Shelves
26494	26495
84H  <p>aligns with 35H base</p>	

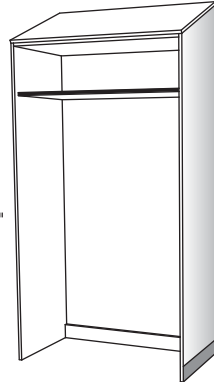
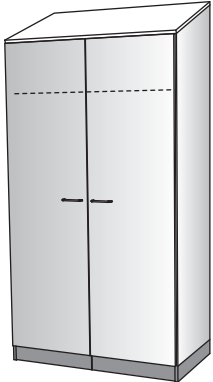
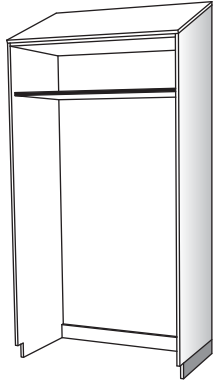
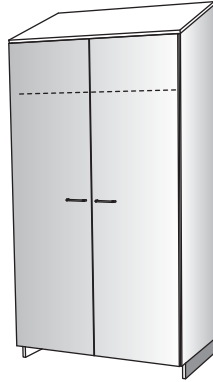
Open Bottom				
Interior Widths 36W = 34" 39W = 37" 42W = 40" 45W = 43" 48W = 46" Interior Depth 24D = 21 ⁷ / ₈ "	W: 36,39,42,45,48 H: 84 D: 24 Fixed Shelf	W: 36,39,42,45,48 H: 84 D: 24 Doors with Attached Toe Kicks (see Design Details) Fixed Shelf	W: 36,39,42,45,48 H: 84 D: 24 Fixed Shelf Toe Kick Notch in End Panels	W: 36,39,42,45,48 H: 84 D: 24 Doors Fixed Shelf Toe Kick Notch in End Panels
	26702	26704	26703	26705
84H  <p>70 3/4" I.D.</p>				

SLOPE TALL



Media Integration / Utility Storage

Slope top units require 26816 slope top cover panel for field installation.
 Height (H) denotes cabinet box height plus toe kick.
 10945 Pin Tray available separately (see Accessories section).

Media Integration

W: 36
H: 84
D: 24

Doors
 Left: Adjustable Shelf, Wardrobe Hook, Mirror
 Right: Adjustable Shelves with Wire Management Slot, Window, Black Vent Grilles, 2 Full Extension Letter File Drawers

W: 36
H: 84
D: 24

Doors
 Left: Adjustable Shelves with Wire Management Slot, Window, Black Vent Grilles, 2 Full Extension Letter File Drawers
 Right: Adjustable Shelf, Wardrobe Hook, Mirror

W: 36
H: 84
D: 21,24

Upper Compartment with Doors, Adjustable Shelf
 Left: Storage Compartment with Left Hinge Door
 Right: 3 Full Extension Lateral File Drawers, Compartment with Hinged Glass Doors, Adjustable Shelf with Wire Management Slot

W: 36
H: 84
D: 21,24

Upper Compartment with Doors, Adjustable Shelf
 Left: 3 Full Extension Lateral File Drawers, Compartment with Hinged Glass Doors, Adjustable Shelf with Wire Management Slot
 Right: Storage Compartment with Right Hinge Door

26674

26675

26676

26677

84H

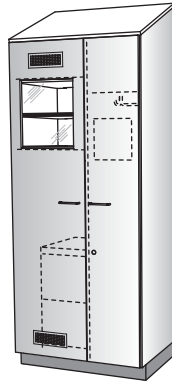
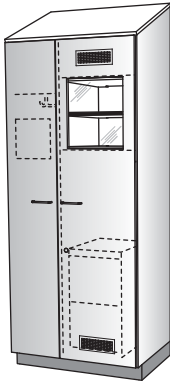

Utility Storage

W: 36,39,42,45,48
H: 84
D: 24

Doors with Hooks Attached to Inside Face:
 (6) Schoolhouse Hooks
 (4) Double J Wall Hooks
 Shallow Depth Shelves

26633

84H

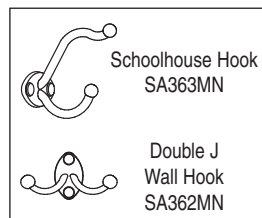
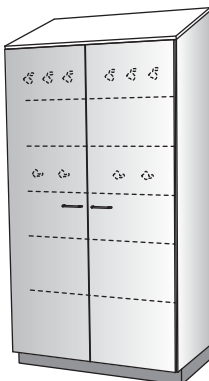

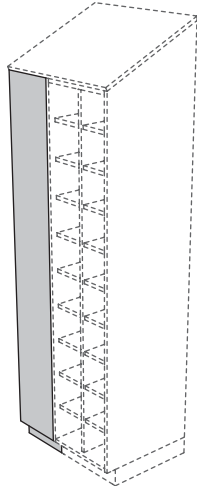
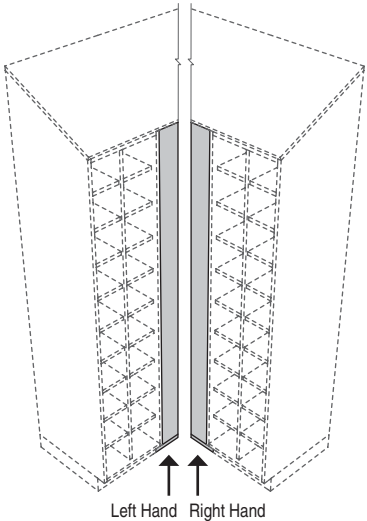
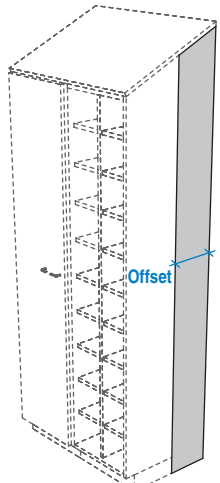
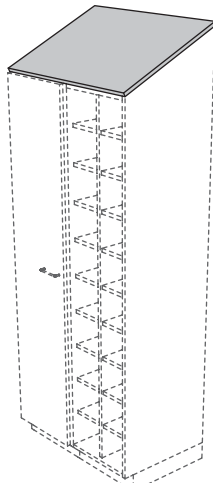
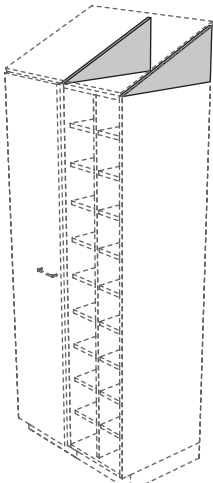
<p>Vertical Scribe</p> <p>W: 00 H: 84 D: 14,18,21,24</p> <p>Field Trim to Fit Actual Thickness=3/4" Actual Depth=3" Edgebanding: One Long Edge in Casebody Trim Color and Thickness</p>	<p>Front Filler</p> <p>W: 02,03,06,09,12 H: 84 D: 14,18,21,24</p> <p>Field Trim to Fit Edgebanding: None</p>	<p>Corner Filler</p> <p>W: 02,03,06,09,12 H: 84 D: 14,18,21,24</p> <p>Field Trim to Fit Depths (D) Listed are Depths of Cabinets to which Filler is Attached Edgebanding: None</p>
<p>25802</p>	<p>25803</p>	<p>25805</p>
		
<p>Side Filler</p> <p>W: 00 H: 84 D: 04,06,08,12,15</p> <p>Field Trim to Fit Edgebanding: One Long Edge in Casebody Trim Color and Thickness</p>	<p>Slope Top Cover Panel</p> <p>W: 36,48,60,72,84,96 H: 00 D: 14,18,21,24</p> <p>Shipped in Lengths for Field Trimming Based on Standard 25° Rise Edgebanding: One Long and 2 Short Edges in Casebody Trim Color and 0.5mm Thickness</p>	<p>Custom Slope Top End Wedge</p> <p>Field Cut to Desired Size Provide Height of Rise Desired Edgebanding: None</p>
<p>26807</p>	<p>26816</p>	<p>26817</p>
		

SLOPE TALL

Installation Accessories



File Crossbars

W: 15
H: 01
D: 00

Pair of Crossbars for 15W File Drawers (Letter)
Allow Side Filing

10896

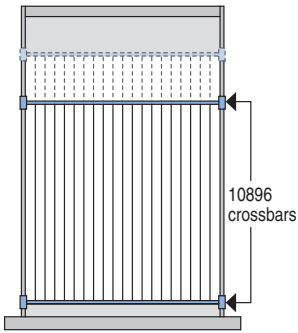

Letter File Drawer
with optional crossbars
installed for side filing

W: 18
H: 01
D: 00

Pair of Crossbars for 18W File Drawers (Legal)
Allow Side Filing

10897

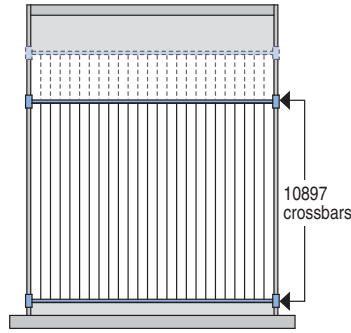

Legal File Drawer
with optional crossbars
installed for side filing

File Bars

W: 00
H: 01
D: 18

1 Pair of File Bars for Lateral File Drawers
Allow Front-to-Back Filing
1 Pair Required for 24W-27W Lateral File Drawers
2 Pairs Required for 30W-42W Lateral File Drawers

10940

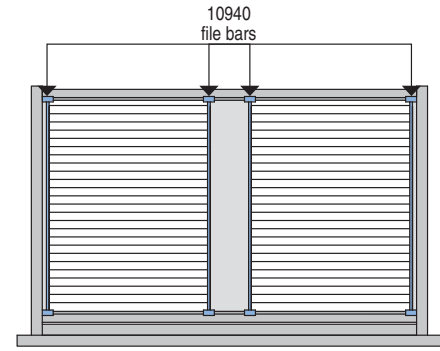

Lateral File Drawer
with two pairs of optional file bars installed
for front-to-back filing

SLOPE TOP

Stevens Advantage slope top units are designed with integral slope ends, eliminating the need for on-the-job fabrication of slope structures. Overlay slope cover panels are shipped with length and end edging for final fit and sizing as installation field conditions may require. Stevens Advantage slope design incorporates a full 3/4" thick slope top on a 25° constant rising slope. Slope top options are available on nominal cabinet depths of 14", 18", 21", and 24". Slope tops not recommended for cabinet height above 84", due to possible ceiling interferences. 26816 Slope Top Cover Panels must be specified and ordered separately (not included with cabinet units).

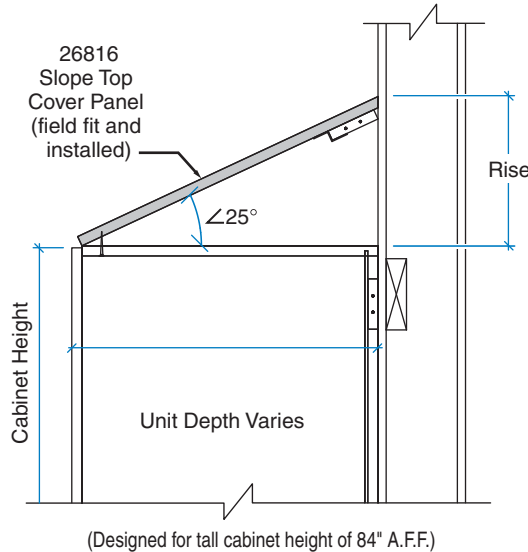

Nominal Unit Depth	Rise	
	inches	mm
14	7	177.9
18	8 3/4	222.6
21	10 3/8	262.8
24	11 1/2	292.8

ATTACHED TOE KICK

For a finished look on an open bottom cabinet with doors, an Attached Toekick is offered on some units. The toekick is black and can have vinyl base applied directly to it.

