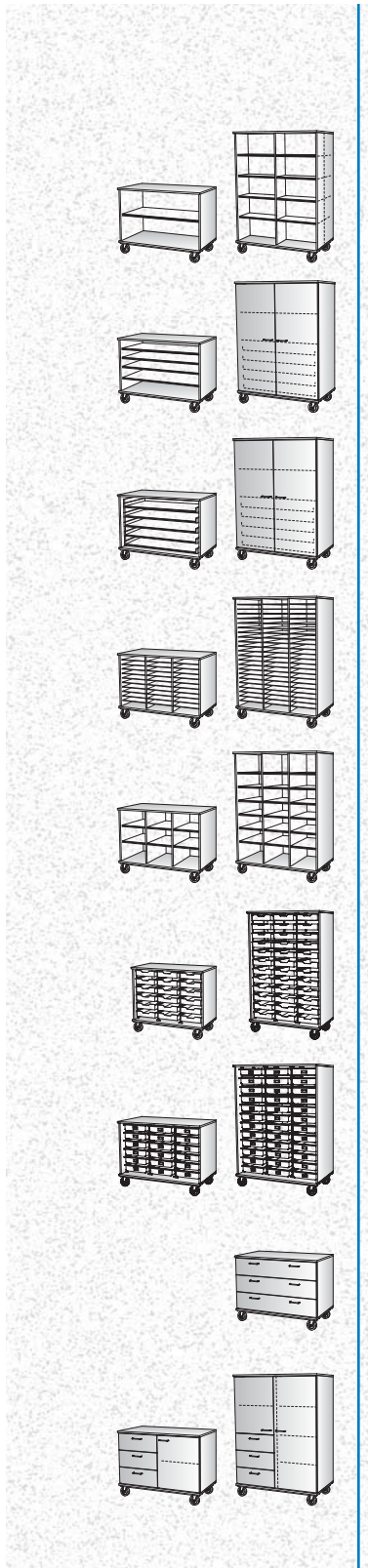

Table of Contents

MOBILES



Shelf 3-4

Paper Storage 5-6

Rollout Shelf 6

Folder 7

Cubicle 8-9

Bin Storage 10

Tray Storage 11-13

Drawer 14-15

Combination Storage 14-16

(continued on page 2)



Table of Contents *(continued)*

Coat Storage.....	17
Locker.....	17
Wardrobe/Storage	18
Demonstration Mobile	19-21
Specialty.....	22-23
Installation Accessories	24

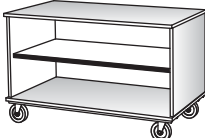
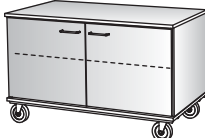
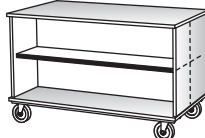
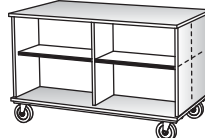
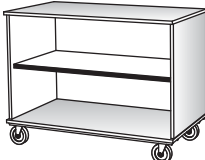
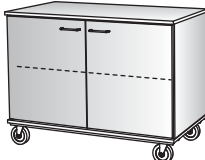
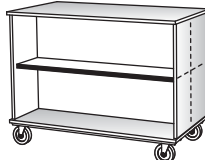
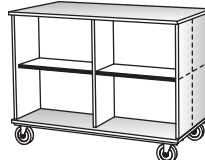
		Shelf			
		W: 36,44,48 H: 30,36 D: 20,24,29 Adjustable Shelf	W: 36,44,48 H: 30,36 D: 20,24,29 Doors Adjustable Shelf	W: 36,44,48 H: 30,36 D: 24,29 Double Sided Adjustable Shelves	W: 36,44,48 H: 30,36 D: 24,29 Double Sided Center Dividers Adjustable Shelves
		60101	60129	60102	60103
30H					
36H					

		Shelf			
		W: 36,44,48 H: 55,67 D: 24,29 Adjustable Shelves	W: 36,44,48 H: 55,67 D: 24,29 Doors Adjustable Shelves	W: 36,44,48 H: 55,67 D: 24,29 Double Sided Adjustable Shelves	W: 36,44,48 H: 55,67 D: 24,29 Double Sided Center Dividers Adjustable Shelves
		60101	60129	60102	60103
55H					
67H					

MOBILES



Shelf

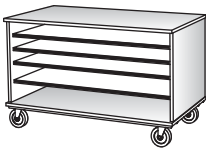
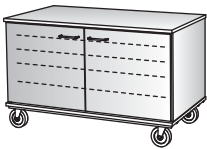
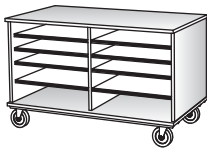
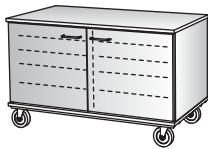
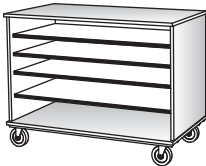
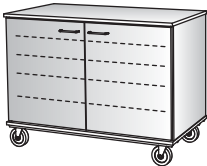
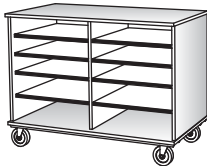
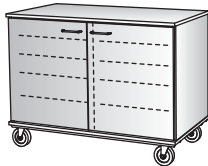

		Shelf		
		W: 36,44,48 H: 30,36 D: 20,24,29 Center Divider Adjustable Shelves	W: 36,44,48 H: 30,36 D: 20,24,29 Doors Center Divider Adjustable Shelves	W: 36,44,48 H: 30,36 D: 20,24,29 Sliding Doors Center Divider Adjustable Shelves
		60138	60181	60150
30H				
36H				

		Shelf			
		W: 36,44,48 H: 55,67 D: 24,29 Center Divider Adjustable Shelves	W: 36,44,48 H: 55,67 D: 24,29 Doors Center Divider Adjustable Shelves	W: 36,44,48 H: 55,67 D: 24,29 1/3-2/3 Configuration Vertical Divider Adjustable Shelves	W: 36,44,48 H: 55,67 D: 24,29 1/3-2/3 Configuration Doors Vertical Divider Adjustable Shelves
		60138	60181	60184	60185
55H					
67H					

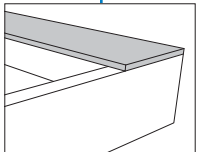

Paper Storage					
Max. Paper Widths 36W = 34" 44W = 42" 48W = 46"	W: 36,44,48 H: 30,36 D: 20,24,29,34	W: 36,44,48 H: 30,36 D: 20,24,29,34	Max. Paper Widths 36W = 16½" 44W = 20½" 48W = 22½"	W: 36,44,48 H: 30,36 D: 20,24,29,34	W: 36,44,48 H: 30,36 D: 20,24,29,34
	Adjustable Shelves Max. Paper Depth: 4" Less Than Unit Depth	Doors Adjustable Shelves Max. Paper Depth: 5" Less Than Unit Depth		Center Divider Adjustable Shelves Max. Paper Depth: 4" Less Than Unit Depth	Doors Center Divider Adjustable Shelves Max. Paper Depth: 5" Less Than Unit Depth
	60116	60115		60118	60117
30H			30H		
36H			36H		

Paper Storage			
Full-Width Drawers Max. Paper Widths 36W = 31" 44W = 39" 48W = 43"	W: 36,44,48 H: 36 D: 24,29,34	W: 36,44,48 H: 36 D: 24,29,34	Max. Paper Widths 36W = 15" 44W = 19" 48W = 21"
	5 Equal Full Extension Drawers Max. Paper Depth: 6" Less Than Unit Depth	Equal Full Extension Drawers: 2 Half-Width, 4 Full-Width Max. Paper Depth: 6" Less Than Unit Depth	
Half-Width Drawers Max. Paper Widths 36W = 15" 44W = 19" 48W = 21"	60393	60394	
36H			
	 <p>Paper storage drawers include rear retaining hoods.</p>		

MOBILES

Paper Storage / Rollout Shelf

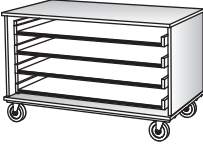

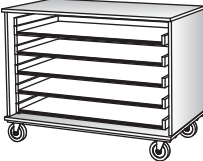
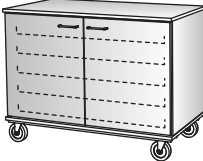

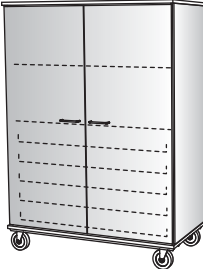

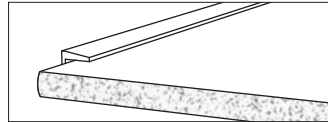

Paper Storage/Rollout Shelf		
Max. Paper Widths 36W = 30" 44W = 38" 48W = 42"	W: 36,44,48 H: 30,36 D: 24,29 Full Extension Rollout Shelves Max. Paper Depth: 5" Less Than Unit Depth	W: 36,44,48 H: 30,36 D: 24,29 Doors Full Extension Rollout Shelves Max. Paper Depth: 5" Less Than Unit Depth
	60492 30H 4 Rollout Shelves 	60493 
36H 5 Rollout Shelves 		

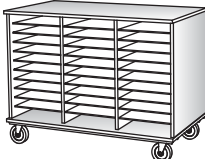
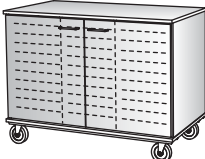
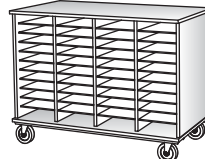
Paper Storage/Rollout Shelf	
Max. Paper Widths 36W = 30" 44W = 38" 48W = 42"	W: 36,44,48 H: 67 D: 24,29 Doors Adjustable Shelf 5 Full Extension Rollout Shelves Max. Paper Depth: 5" Less Than Unit Depth
	60494 67H 

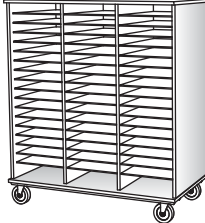
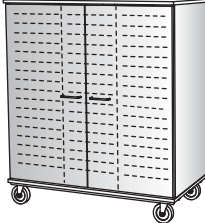
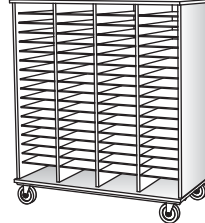

1/4"-thick folder shelves are held securely with translucent, low profile shelf supports. All edges unfinished. Front edge unfinished and shaped.

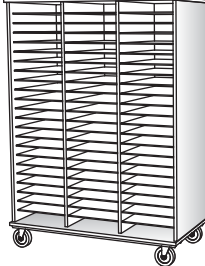
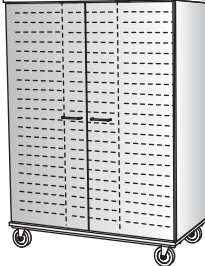
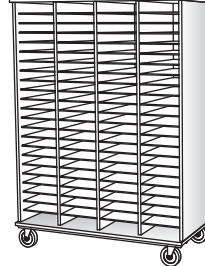
Folder		Folder		Folder		Folder	
Compt. Width 15"	W: 48 H: 36 D: 24 1/4" Folder Shelves, Adjustable and Removable on 1 1/4" Centers Compartments 2 1/4"H min.	W: 48 H: 36 D: 24 Doors 1/4" Folder Shelves, Adjustable and Removable on 1 1/4" Centers Compartments 2 1/4"H min.	Compt. Width 11"	W: 48 H: 36 D: 24 1/4" Folder Shelves, Adjustable and Removable on 1 1/4" Centers Compartments 2 1/4"H min.	W: 48 H: 36 D: 24 Doors 1/4" Folder Shelves, Adjustable and Removable on 1 1/4" Centers Compartments 2 1/4"H min.		
	60647	60648		60649	60650		
36H 33 Compts.			36H 44 Compts.				

Folder		Folder		Folder		Folder	
Compt. Width 15"	W: 48 H: 55,67 D: 24 1/4" Folder Shelves, Adjustable and Removable on 1 1/4" Centers Compartments 2 1/4"H min.	W: 48 H: 55,67 D: 24 Doors 1/4" Folder Shelves, Adjustable and Removable on 1 1/4" Centers Compartments 2 1/4"H min.	Compt. Width 11"	W: 48 H: 55,67 D: 24 1/4" Folder Shelves, Adjustable and Removable on 1 1/4" Centers Compartments 2 1/4"H min.	W: 48 H: 55,67 D: 24 Doors 1/4" Folder Shelves, Adjustable and Removable on 1 1/4" Centers Compartments 2 1/4"H min.		
	60647	60648		60649	60650		
55H 54 Compts.			55H 72 Compts.				
67H 69 Compts.			67H 92 Compts.				

MOBILES





Cubicle

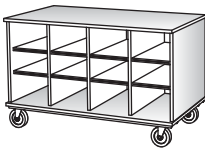
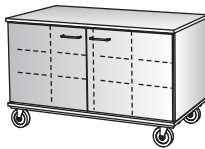
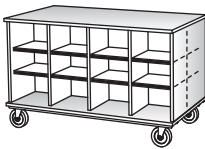
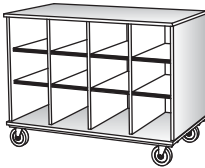
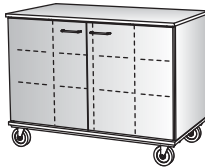
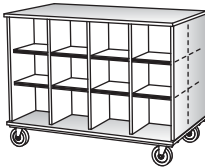

Cubicle			
Compt. Widths 36W = 11" 44W = 13½" 48W = 15"	W: 36,44,48 H: 30,36 D: 20,24 ¾" Adjustable Cubicle Shelves Compartment Spacing 3"H min.	W: 36,44,48 H: 30,36 D: 20,24 Doors ¾" Adjustable Cubicle Shelves Compartment Spacing 3"H min.	W: 36,44,48 H: 30,36 D: 24,29 Double Sided ¾" Adjustable Cubicle Shelves Compartment Spacing 3"H min.
	60226	60227	60233
30H 9 Compts.			30H 18 Compts.
36H 9 Compts.			36H 18 Compts.

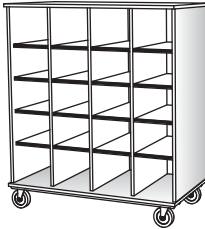
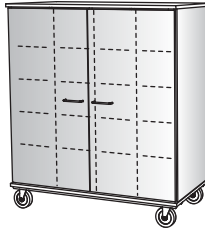
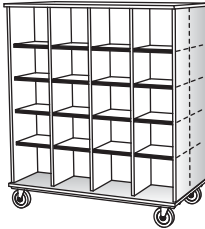
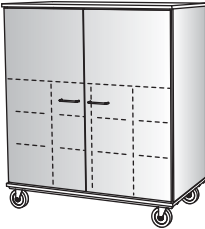
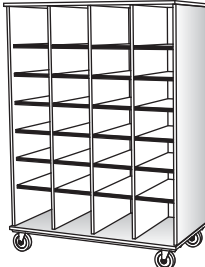
Cubicle				
Compt. Widths 36W = 11" 44W = 13½" 48W = 15"	W: 36,44,48 H: 55,67 D: 24 ¾" Adjustable Cubicle Shelves Compartment Spacing 3"H min.	W: 36,44,48 H: 55,67 D: 24 Doors ¾" Adjustable Cubicle Shelves Compartment Spacing 3"H min.	W: 36,44,48 H: 55,67 D: 24,29 Double Sided ¾" Adjustable Cubicle Shelves Compartment Spacing 3"H min.	W: 36,44,48 H: 55,67 D: 24 Doors Adjustable Shelf (67H only) ¾" Adjustable Cubicle Shelves Compartment Spacing 3"H min.
	60226	60227	60233	60232
55H 15 Compts.			55H 30 Compts. 	55H 9 Compts.
67H 21 Compts.			67H 42 Compts. 	67H 9 Compts.

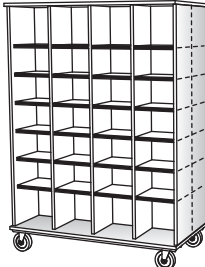
Cubicle			
<p>Compt. Widths 36W = 8" 44W = 10" 48W = 11"</p>	<p>W: 36,44,48 H: 30,36 D: 20,24</p> <p>¾" Adjustable Cubicle Shelves Compartment Spacing 3"H min.</p>	<p>W: 36,44,48 H: 30,36 D: 20,24</p> <p>Doors ¾" Adjustable Cubicle Shelves Compartment Spacing 3"H min.</p>	<p>W: 36,44,48 H: 30,36 D: 24,29</p> <p>Double Sided ¾" Adjustable Cubicle Shelves Compartment Spacing 3"H min.</p>
	60239	60240	60235
<p>30H 12 Compts.</p> 		<p>30H 24 Compts.</p> 	
<p>36H 12 Compts.</p> 		<p>36H 24 Compts.</p> 	

Cubicle				
<p>Compt. Widths 36W = 8" 44W = 10" 48W = 11"</p>	<p>W: 36,44,48 H: 55,67 D: 24</p> <p>¾" Adjustable Cubicle Shelves Compartment Spacing 3"H min.</p>	<p>W: 36,44,48 H: 55,67 D: 24</p> <p>Doors ¾" Adjustable Cubicle Shelves Compartment Spacing 3"H min.</p>	<p>W: 36,44,48 H: 55,67 D: 24,29</p> <p>Double Sided ¾" Adjustable Cubicle Shelves Compartment Spacing 3"H min.</p>	<p>W: 36,44,48 H: 55,67 D: 24</p> <p>Doors Adjustable Shelf (67H only) ¾" Adjustable Cubicle Shelves Compartment Spacing 3"H min.</p>
	60239	60240	60235	60247
<p>55H 20 Compts.</p> 		<p>55H 40 Compts.</p> 	<p>55H 12 Compts.</p> 	
<p>67H 28 Compts.</p> 		<p>67H 56 Compts.</p> 	<p>67H 12 Compts.</p> 	

MOBILES

Bin Storage



SA910: 12 $\frac{1}{4}$ W x 3H x 16 $\frac{3}{4}$ D



SA911: 12 $\frac{1}{4}$ W x 6H x 16 $\frac{3}{4}$ D

Bin Storage

W: 44
H: 30,36
D: 24

Molded Translucent Bins

W: 44
H: 30,36
D: 24

Doors
Molded Translucent Bins

W: 44
H: 30,36
D: 24

Molded Translucent Bins

W: 44
H: 30,36
D: 24

Doors
Molded Translucent Bins

60242

30H
(12) SA910
Bins

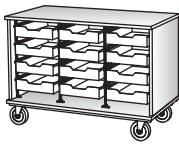

60243

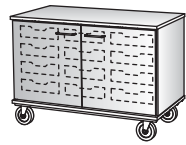

60248

30H
(6) SA911
Bins

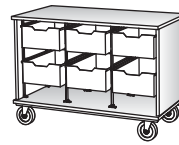

60249

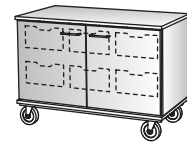

36H
(18) SA910
Bins

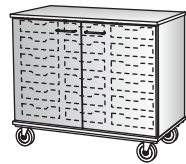
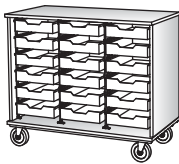

36H
(9) SA911
Bins

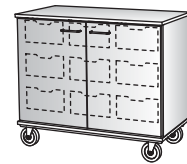
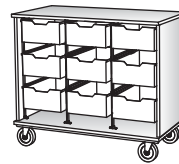

Bin Storage

W: 44
H: 55,67
D: 24

Molded Translucent Bins

W: 44
H: 55,67
D: 24

Doors
Molded Translucent Bins

W: 44
H: 55,67
D: 24

Molded Translucent Bins

W: 44
H: 55,67
D: 24

Doors
Molded Translucent Bins

60242

55H
(27) SA910
Bins

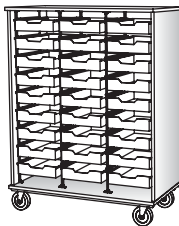

60243

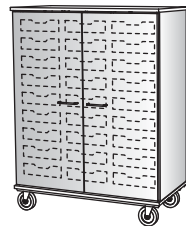

60248

55H
(3) SA910
Bins
(12) SA911
Bins



60249

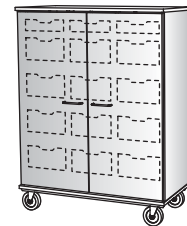

67H
(36) SA910
Bins

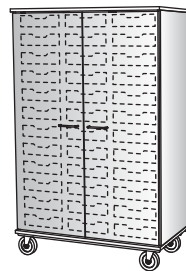
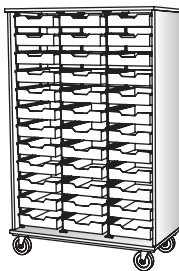

67H
(18) SA911
Bins

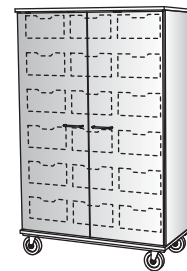











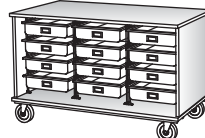
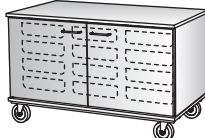

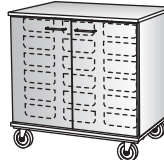
SA901: 14 1/4W x 3 1/2H x 19D

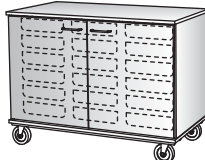

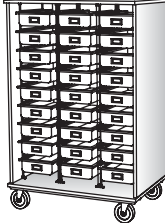
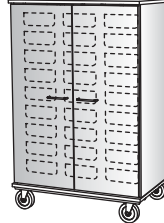
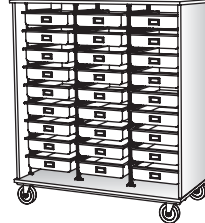
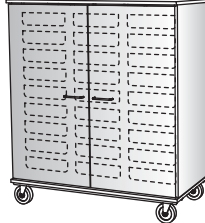
SA902: 10W x 3 1/2H x 19D

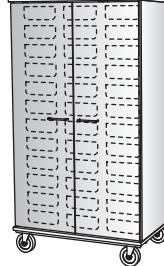
Tray Storage		Tray Storage		Tray Storage			
<p>W: 36 H: 30,36 D: 24</p> <p>Molded Trays with Card Holder</p>	<p>W: 36 H: 30,36 D: 24</p> <p>Doors Molded Trays with Card Holder</p>	<p>W: 48 H: 30,36 D: 24</p> <p>Molded Trays with Card Holder</p>	<p>W: 48 H: 30,36 D: 24</p> <p>Doors Molded Trays with Card Holder</p>	<p>60270</p> <p>30H (12) SA902 Trays</p> 	<p>60271</p> 	<p>60274</p> <p>30H (12) SA901 Trays</p> 	<p>60275</p> 
<p>36H (18) SA902 Trays</p> 		<p>36H (18) SA901 Trays</p> 					

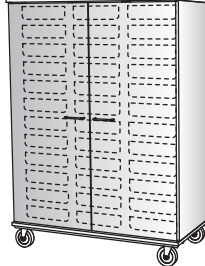
Tray Storage		Tray Storage		Tray Storage			
<p>W: 36 H: 55,67 D: 24</p> <p>Molded Trays with Card Holder</p>	<p>W: 36 H: 55,67 D: 24</p> <p>Doors Molded Trays with Card Holder</p>	<p>W: 48 H: 55,67 D: 24</p> <p>Molded Trays with Card Holder</p>	<p>W: 48 H: 55,67 D: 24</p> <p>Doors Molded Trays with Card Holder</p>	<p>60270</p> <p>55H (27) SA902 Trays</p> 	<p>60271</p> 	<p>60274</p> <p>55H (27) SA901 Trays</p> 	<p>60275</p> 
<p>67H (36) SA902 Trays</p> 		<p>67H (36) SA901 Trays</p> 					

MOBILES

Tray Storage



SA902: 10W x 3 1/2H x 19D

Tray Storage

W: 48
H: 30,36
D: 24

Molded Trays with Card Holder

W: 48
H: 30,36
D: 24

Doors
Molded Trays with Card Holder

60281

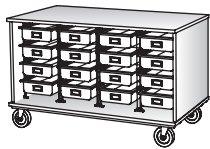

30H
(16) SA902
Trays

60282

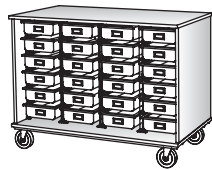
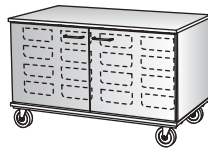

36H
(24) SA902
Trays

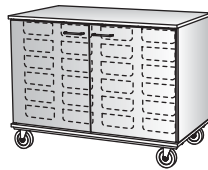

Tray Storage

W: 48
H: 55,67
D: 24

Molded Trays with Card Holder

W: 48
H: 55,67
D: 24

Doors
Molded Trays with Card Holder

60281

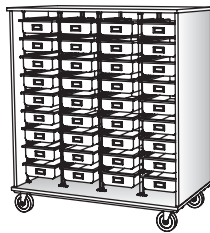

55H
(36) SA902
Trays

60282

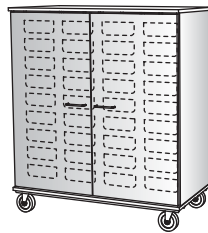

67H
(48) SA902
Trays

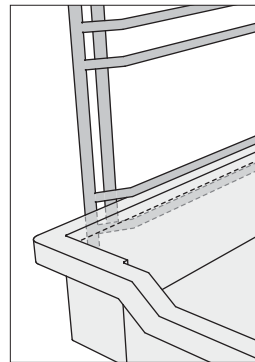
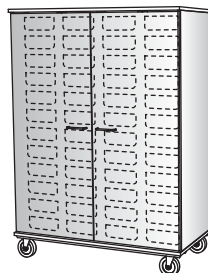



Bin and tray racks have captured runner rail to reduce tray tipout.



SA901: 14 1/4W x 3 1/2H x 19D

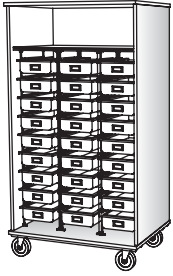
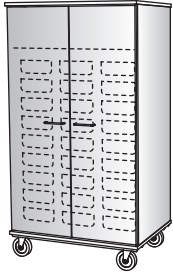

SA902: 10W x 3 1/2H x 19D

Tray Storage			
	<p>W: 36 H: 67 D: 24</p> <p>Upper Compartment (27) SA902 Molded Trays with Card Holder</p>	<p>W: 36 H: 67 D: 24</p> <p>Doors Upper Compartment (27) SA902 Molded Trays with Card Holder</p>	<p>W: 48 H: 67 D: 24</p> <p>Doors Adjustable Shelf (24) SA902 Molded Trays with Card Holder</p>
	60283	60284	60310
67H			

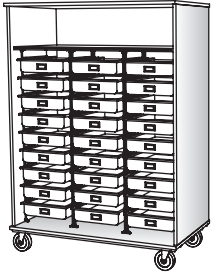
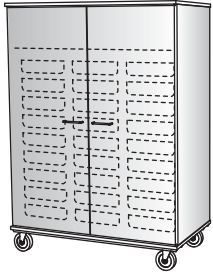
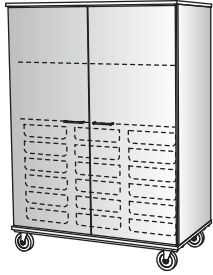
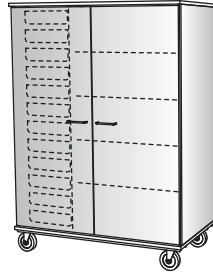
Tray Storage				
	<p>W: 48 H: 67 D: 24</p> <p>Upper Compartment (27) SA901 Molded Trays with Card Holder</p>	<p>W: 48 H: 67 D: 24</p> <p>Doors Upper Compartment (27) SA901 Molded Trays with Card Holder</p>	<p>W: 48 H: 67 D: 24</p> <p>Doors Adjustable Shelf (18) SA901 Molded Trays with Card Holder</p>	<p>W: 48 H: 67 D: 24</p> <p>1/3-2/3 Configuration Doors Vertical Divider Left: (12) SA901 Molded Trays with Card Holder Right: Adjustable Shelves</p>
	60285	60286	60306	60599
67H				













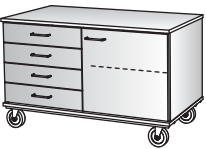

MOBILES

Drawer / Combination Storage



	Drawer			Combination Storage	
	<p>W: 36,44,48 H: 30,36 D: 24</p> <p>3 Equal Drawers</p>	<p>W: 36,44,48 H: 30,36 D: 24</p> <p>Equal Drawers: 2 Half-Width, 2 Full-Width</p>	<p>W: 36,44,48 H: 30,36 D: 24</p> <p>6 Equal Drawers</p>	<p>W: 36,44,48 H: 30,36 D: 24</p> <p>Right Hinge Door Adjustable Shelf 3 Equal Drawers</p>	<p>W: 36,44,48 H: 30,36 D: 24</p> <p>Left Hinge Door Adjustable Shelf 3 Equal Drawers</p>
	60334	60343	60344	60338	60339
30H					
36H					
	Combination Storage				
	<p>W: 36,44,48 H: 67 D: 24</p> <p>Doors Center Divider Adjustable Shelves 3 Equal Drawers</p>	<p>W: 36,44,48 H: 67 D: 24</p> <p>Doors Center Divider Adjustable Shelves Equal Drawers: 2 Half-Width, 2 Full-Width</p>	<p>W: 36,44,48 H: 67 D: 24</p> <p>Doors Center Divider Adjustable Shelves 6 Equal Drawers</p>	<p>W: 36,44,48 H: 67 D: 24</p> <p>Doors Center Divider Right: Adjustable Shelves Left: Adjustable Shelf, 3 Equal Drawers</p>	<p>W: 36,44,48 H: 67 D: 24</p> <p>Doors Center Divider Left: Adjustable Shelves Right: Adjustable Shelf, 3 Equal Drawers</p>
	60336	60349	60346	60347	60348
67H					

Drawer / Combination Storage

	Drawer			Combination Storage	
	<p>W: 36,44,48 H: 30,36 D: 24</p> <p>4 Equal Drawers</p>	<p>W: 36,44,48 H: 30,36 D: 24</p> <p>Equal Drawers: 2 Half-Width, 3 Full-Width</p>	<p>W: 36,44,48 H: 30,36 D: 24</p> <p>8 Equal Drawers</p>	<p>W: 36,44,48 H: 30,36 D: 24</p> <p>Right Hinge Door Adjustable Shelf 4 Equal Drawers</p>	<p>W: 36,44,48 H: 30,36 D: 24</p> <p>Left Hinge Door Adjustable Shelf 4 Equal Drawers</p>
	60371	60382	60383	60381	60380
30H					
36H					
	Combination Storage				
	<p>W: 36,44,48 H: 67 D: 24</p> <p>Doors Center Divider Adjustable Shelves 4 Equal Drawers</p>	<p>W: 36,44,48 H: 67 D: 24</p> <p>Doors Center Divider Adjustable Shelves Equal Drawers: 2 Half-Width, 3 Full-Width</p>	<p>W: 36,44,48 H: 67 D: 24</p> <p>Doors Center Divider Adjustable Shelves 8 Equal Drawers</p>	<p>W: 36,44,48 H: 67 D: 24</p> <p>Doors Center Divider Right: Adjustable Shelves Left: Adjustable Shelf, 4 Equal Drawers</p>	<p>W: 36,44,48 H: 67 D: 24</p> <p>Doors Center Divider Left: Adjustable Shelves Right: Adjustable Shelf, 4 Equal Drawers</p>
	60375	60386	60388	60376	60377
67H					

MOBILES

Combination Storage



Combination Storage

W: 36,44,48
H: 36
D: 24

Drawer
Doors
Adjustable Shelf

W: 36,44,48
H: 36
D: 24

2 Equal Drawers
Doors
Center Divider
Adjustable Shelves

60430

60432

36H



Combination Storage

W: 48
H: 67
D: 24

Sliding Glass Doors
Center Divider
Adjustable Shelves
4 Equal Drawers

W: 36,44,48
H: 67
D: 24



Upper/Lower Doors
Center Dividers
Adjustable Shelves
2 Equal Drawers

60160

60434

67H

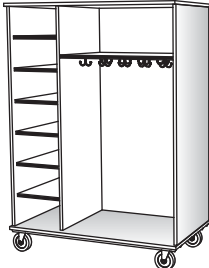
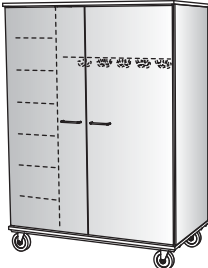
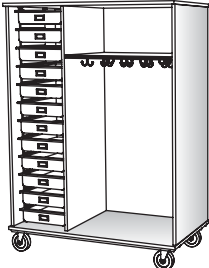
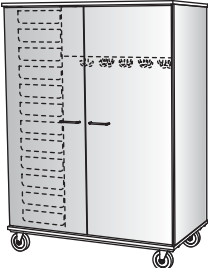

Coat Storage				
	<p>W: 48 H: 67 D: 24</p> <p>1/3-2/3 Configuration Vertical Divider Left: Adjustable Shelves Right: Adjustable Shelf, 10 Double Hooks</p>	<p>W: 48 H: 67 D: 24</p> <p>1/3-2/3 Configuration Doors Vertical Divider Left: Adjustable Shelves Right: Adjustable Shelf, 10 Double Hooks</p>	<p>W: 48 H: 67 D: 24</p> <p>1/3-2/3 Configuration Vertical Divider Left: (12) SA901 Molded Trays with Card Holder Right: Adjustable Shelf, 10 Double Hooks</p>	<p>W: 48 H: 67 D: 24</p> <p>1/3-2/3 Configuration Doors Vertical Divider Left: (12) SA901 Molded Trays with Card Holder Right: Adjustable Shelf, 10 Double Hooks</p>
	60186	60187	60590	60591
67H				
				SA901: 14 1/4W x 3 1/2H x 19D

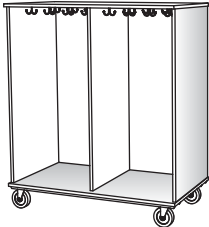
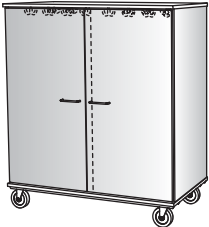
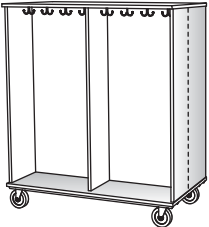
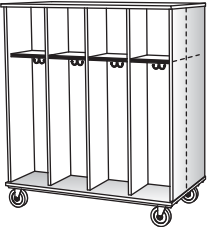
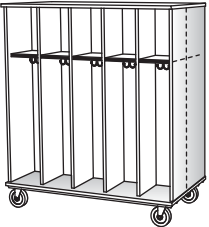
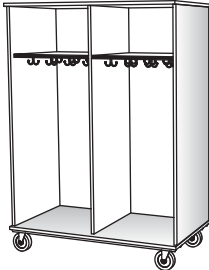
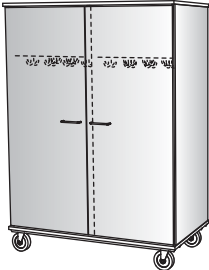
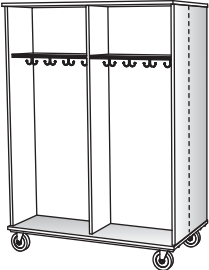
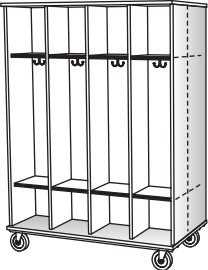
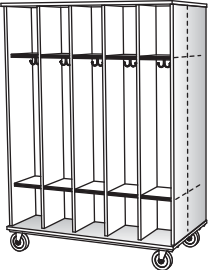
Coat Storage			Locker		
	<p>W: 48 H: 55,67 D: 24</p> <p>Center Divider 16 Double Hooks Adjustable Shelves (67H only)</p>	<p>W: 48 H: 55,67 D: 24</p> <p>Doors Center Divider 16 Double Hooks Adjustable Shelves (67H only)</p>	<p>W: 48 H: 55,67 D: 24,29</p> <p>Double Sided Center Dividers 16 Double Hooks Adjustable Shelves (67H only)</p>	<p>W: 48 H: 55,67 D: 24,29</p> <p>Double Sided 8 Compartments (11W) 8 Double Hooks Adjustable Shelves</p>	<p>W: 48 H: 55,67 D: 24,29</p> <p>Double Sided 10 Compartments (8 5/8W) 10 Double Hooks Adjustable Shelves</p>
	60582	60583	60584	60612	60613
55H					
67H					

MOBILES

Wardrobe / Storage



Wardrobe/Storage

W: 36
H: 67
D: 24

Adjustable Shelf
Hanger Bar

60555

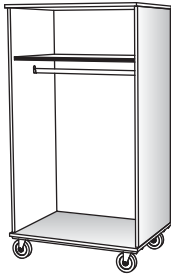

W: 36
H: 67
D: 24

Doors
Adjustable Shelf
Hanger Bar

60556

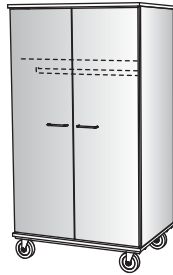

W: 48
H: 67
D: 24

Center Divider
Adjustable Shelves
Hanger Bars

60560

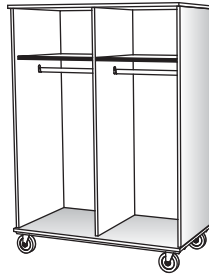

W: 48
H: 67
D: 24

Doors
Center Divider
Adjustable Shelves
Hanger Bars

60561



67H

Wardrobe/Storage

W: 48
H: 67
D: 24

1/3-2/3 Configuration
Doors
Vertical Divider
Left: Wardrobe Hook, Mirror
Right: Adjustable Shelves
10945 Pin Tray Available Separately
(see Accessories section)

60603

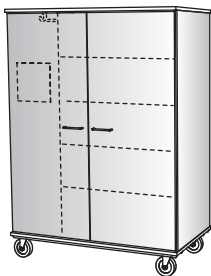

W: 48
H: 67
D: 24

1/3-2/3 Configuration
Doors
Vertical Divider
Left: Wardrobe Hook, Mirror
Right: Adjustable Shelves, 2 Full
Extension Letter File Drawers
10945 Pin Tray Available Separately
(see Accessories section)

60606

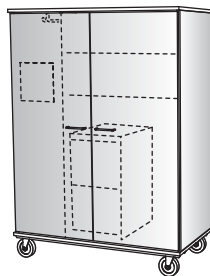

W: 48
H: 67
D: 24

1/3-2/3 Configuration
Doors
Vertical Divider
Left: Wardrobe Hook, Mirror
Right: Adjustable Shelves, 2 Full
Extension Legal File Drawers
10945 Pin Tray Available Separately
(see Accessories section)

60609

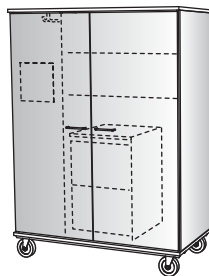





67H

Letter and legal file drawers are designed for front-to-back filing.
Optional crossbars allow side filing.
See Installation Accessories.

Demonstration Mobile

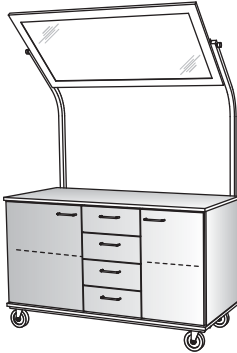
Demonstration mobiles with mirror are designed to roll through a standard 6'8" doorway.
Distance from floor to mirror pivot point is 76".

Demonstration Mobile				
	<p>W: 48 H: 36 D: 24,29</p> <p>Demonstration Mirror Left Hinge Door Adjustable Shelf 3 Equal Drawers</p>	<p>W: 59 H: 36 D: 24,29</p> <p>Demonstration Mirror Doors Adjustable Shelves 3 Equal Drawers</p>	<p>W: 48 H: 36 D: 24,29</p> <p>Demonstration Mirror Left Hinge Door Adjustable Shelf 4 Equal Drawers</p>	<p>W: 59 H: 36 D: 24,29</p> <p>Demonstration Mirror Doors Adjustable Shelves 4 Equal Drawers</p>
	60733	60731	60728	60729
36H				

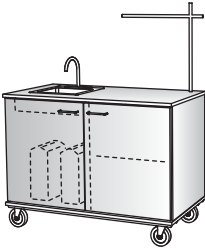
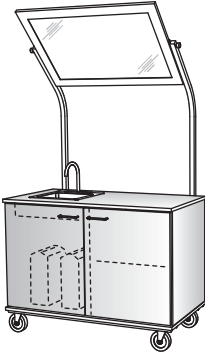
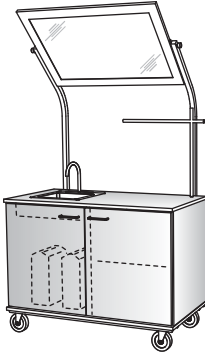
Demonstration Mobile				
	<p>W: 48 H: 36 D: 24,29</p> <p>Sink with Galley Pump Doors Adjustable Shelf 2 Jericans</p>	<p>W: 48 H: 36 D: 24,29</p> <p>Apparatus Rod and Socket Sink with Galley Pump Doors Adjustable Shelf 2 Jericans</p>	<p>W: 48 H: 36 D: 24,29</p> <p>Demonstration Mirror Sink with Galley Pump Doors Adjustable Shelf 2 Jericans</p>	<p>W: 48 H: 36 D: 24,29</p> <p>Demonstration Mirror Apparatus Rod and Socket Sink with Galley Pump Doors Adjustable Shelf 2 Jericans</p>
	60743	60726	60744	60745
36H				

MOBILES

Demonstration Mobile

Demonstration mobiles with mirror are designed to roll through a standard 6'8" doorway.
Distance from floor to mirror pivot point is 76".









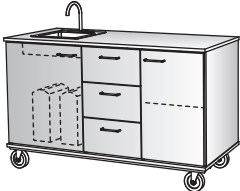

Demonstration Mobile				
	<p>W: 48 H: 36 D: 24,29</p> <p>Sink with Galley Pump Left Hinge Door 2 Jericans 3 Equal Drawers</p>	<p>W: 48 H: 36 D: 24,29</p> <p>Apparatus Rod and Socket Sink with Galley Pump Left Hinge Door 2 Jericans 3 Equal Drawers</p>	<p>W: 48 H: 36 D: 24,29</p> <p>Demonstration Mirror Sink with Galley Pump Left Hinge Door 2 Jericans 3 Equal Drawers</p>	<p>W: 48 H: 36 D: 24,29</p> <p>Demonstration Mirror Apparatus Rod and Socket Sink with Galley Pump Left Hinge Door 2 Jericans 3 Equal Drawers</p>
	60739	60727	60740	60746
36H				

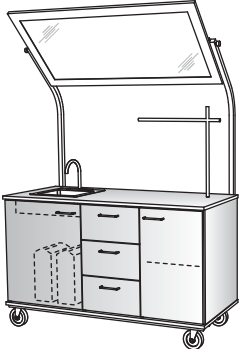
Demonstration Mobile				
	<p>W: 48 H: 36 D: 24,29</p> <p>Sink with Galley Pump Left Hinge Door 2 Jericans 4 Equal Drawers</p>	<p>W: 48 H: 36 D: 24,29</p> <p>Apparatus Rod and Socket Sink with Galley Pump Left Hinge Door 2 Jericans 4 Equal Drawers</p>	<p>W: 48 H: 36 D: 24,29</p> <p>Demonstration Mirror Sink with Galley Pump Left Hinge Door 2 Jericans 4 Equal Drawers</p>	<p>W: 48 H: 36 D: 24,29</p> <p>Demonstration Mirror Apparatus Rod and Socket Sink with Galley Pump Left Hinge Door 2 Jericans 4 Equal Drawers</p>
	60747	60748	60749	60750
36H				

Demonstration Mobile

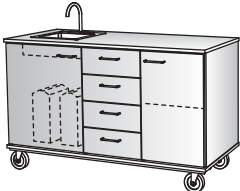
Demonstration mobiles with mirror are designed to roll through a standard 6'8" doorway.
Distance from floor to mirror pivot point is 76".

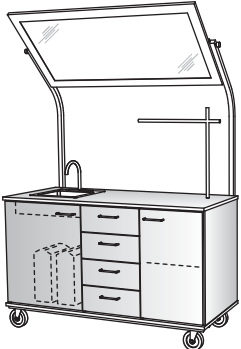

Demonstration Mobile				
	<p>W: 59 H: 36 D: 24,29</p> <p>Sink with Galley Pump Doors Adjustable Shelf 2 Jericans 3 Equal Drawers</p>	<p>W: 59 H: 36 D: 24,29</p> <p>Demonstration Mirror Sink with Galley Pump Doors Adjustable Shelf 2 Jericans 3 Equal Drawers</p>	<p>W: 59 H: 36 D: 24,29</p> <p>Demonstration Mirror Apparatus Rod and Socket Sink with Galley Pump Doors Adjustable Shelf 2 Jericans 3 Equal Drawers</p>	<p>W: 59 H: 36 D: 24,29</p> <p>Demonstration Mirror Sink with Galley Pump 2-Burner Cooktop Doors 2 Jericans Adjustable Shelf 3 Equal Drawers</p>
	60741	60742	60736	60732
36H				



Demonstration Mobile				
	<p>W: 59 H: 36 D: 24,29</p> <p>Sink with Galley Pump Doors Adjustable Shelf 2 Jericans 4 Equal Drawers</p>	<p>W: 59 H: 36 D: 24,29</p> <p>Demonstration Mirror Sink with Galley Pump Doors Adjustable Shelf 2 Jericans 4 Equal Drawers</p>	<p>W: 59 H: 36 D: 24,29</p> <p>Demonstration Mirror Apparatus Rod and Socket Sink with Galley Pump Doors Adjustable Shelf 2 Jericans 4 Equal Drawers</p>	<p>W: 59 H: 36 D: 24,29</p> <p>Demonstration Mirror Sink with Galley Pump 2-Burner Cooktop Doors 2 Jericans Adjustable Shelf 4 Equal Drawers</p>
	60751	60752	60753	60730
36H				

MOBILES



Specialty

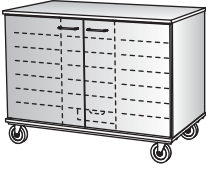

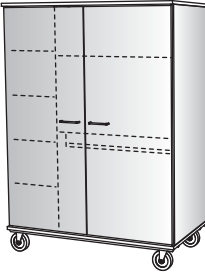
Specialty	
<p>File Drawer</p> <p>W: 44 H: 34 D: 24,29</p> <p>6 Full Extension Letter File Drawers</p>	<p>Instructor Podium</p> <p>W: 36,48 H: 42 D: 24</p> <p>Podium Adjustable Shelf Drawer 2 Full Extension Letter File Drawers All Exterior Color</p>
<p>60322</p> <p>34H</p> 	<p>60720</p> <p>42H</p> 
<p>Letter file drawers are designed for front-to-back filing. Optional crossbars allow side filing. See Installation Accessories.</p>	

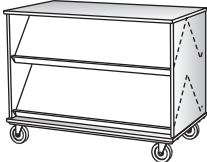
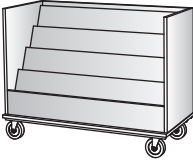
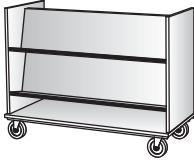
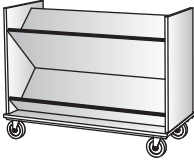
Specialty	
<p>Technology Storage</p> <p>W: 48 H: 36 D: 24</p> <p>Locked Doors Adjustable Shelves Storage for 20 Laptops (1) SA910 Molded Translucent Bin</p>	<p>Technology Storage</p> <p>W: 48 H: 67 D: 24</p> <p>Locked Doors Left: Adjustable Shelves Right: Computer Compartment, Adjustable Printer Shelf, Fixed CPU and Monitor Shelf, Pullout Keyboard Tray on Full Extension Slides</p>
<p>60119</p> <p>36H</p>   <p>SA910: 12¹/₄W x 3H x 16³/₄D</p>	<p>60610</p> <p>67H</p> 

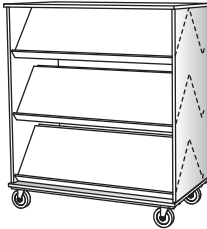
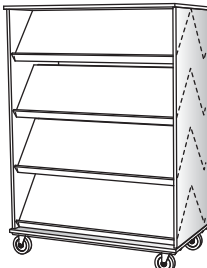
Specialty				
	Magazine Shelf	Periodical Display	Sloped Book Truck	Encyclopedia Cart
	W: 48 H: 36 D: 24 Double Sided 4 Sloped Magazine Shelves	W: 36,48 H: 36 D: 20 4 Display Shelves All Exterior Color	W: 36,48 H: 36 D: 20 Double Sided Access 4 Fixed Sloped Display Shelves All Exterior Color	W: 36,48 H: 36 D: 20 Double Sided Access 3 Fixed Sloped Display Shelves All Exterior Color
	60174	60755	60757	60758
36H				

Specialty			
	Magazine Shelf		
	W: 48 H: 55,67 D: 24 Double Sided 55H=6 Sloped Magazine Shelves 67H=8 Sloped Magazine Shelves	W: 48 H: 67 D: 24 2 Sloped Magazine Shelves Lower Doors Adjustable Shelf	W: 48 H: 67 D: 24 2 Sloped Magazine Shelves 4 Equal Drawers
	60174	60165	60166
55H			
67H			

MOBILES

Installation Accessories



File Crossbars

W: 15
H: 01
D: 00

Pair of Crossbars for 15W File Drawers (Letter)
Allow Side Filing

W: 18
H: 01
D: 00

Pair of Crossbars for 18W File Drawers (Legal)
Allow Side Filing

10896

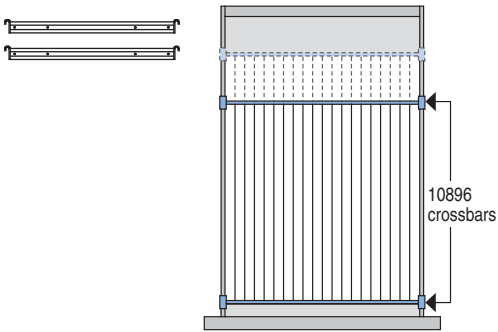

Letter File Drawer
with optional crossbars
installed for side filing

10897

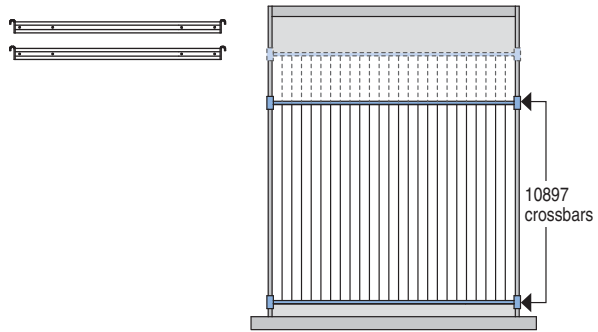

Legal File Drawer
with optional crossbars
installed for side filing