



UPDATE HISTORY

Home Arts Section



This UPDATE HISTORY outlines changes made to the Stevens Advantage Commercial Cabinetry and Millwork catalog since it was published in May 2014.

The most recent updates are shown first.

Go to stevensadvantage.com

→ RESOURCES

→ Commercial Casework

to view/download/print
the most current catalog sections.

Later updates supercede earlier updates.

(Revisions shown in **RED**)

UPDATE HISTORY

Home Arts Section



DECEMBER 2017			
MODEL #	TYPE OF UPDATE	DESCRIPTION OF UPDATE	CATALOG PAGE #
	Description	Changed "Available Top Series" to "Suggested Top Series" on charts; added note at top of page: "See Countertop section for available top series"; changed PS60 suggested top series to PS59 (profile edge did not change)	4,5,6,7,8,9,12,32,33
	Description	Added note: demonstration mobiles with mirror are designed to roll through standard 6'8" doorway.	14
10688	Dimensions	Added 32H	22
10689	Dimensions	Added 32H	22
10694	Dimensions	Added 32H	22
10958	Dimensions	Revised mirror frame dimensions	25
10959	Dimensions	Revised mirror frame dimensions	25
35008	Dimensions	Deleted 32H; added 29H	27
35010	Dimensions	Deleted 32H; added 29H	27

Table of Contents

HOME ARTS – CULINARY

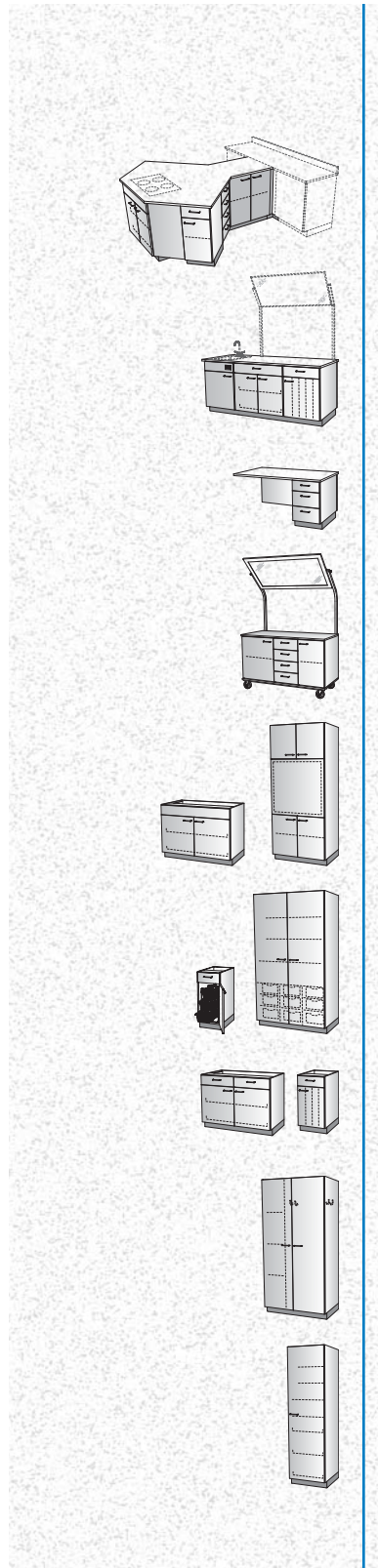

Cooking/Food Preparation4-5

Demonstration Island.....6-11

Desk Extension 12-13

Demonstration Mobile 14

Cooking/Baking 15-16

Food Storage 17

Pan/Tray Storage..... 18







Broom/Utility Storage 19

Pantry Storage..... 19

(continued on page 2)

Table of Contents *(continued)*

HOME ARTS – CULINARY

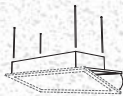
	Above Refrigerator Storage.....	20-21
	Recycling/Waste Bin.....	22
	Smock Storage.....	23
	Linen Storage	23
	Hamper	24
	Towel Storage.....	24
	Clothing Storage	24
	Demonstration Mirror/Accessories	25

(continued on page 3)

Table of Contents *(continued)*

HOME ARTS – SEWING

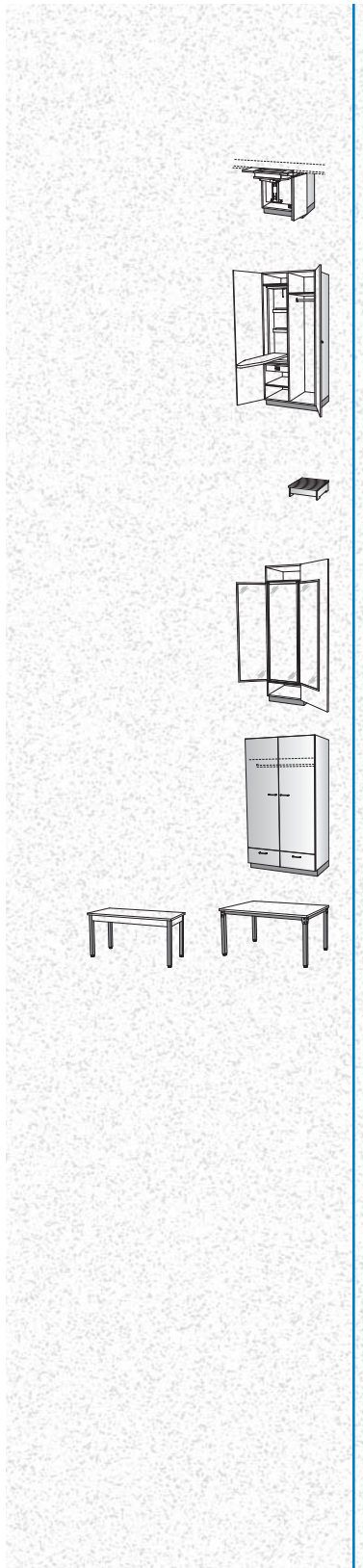

Sewing Cabinet26-27

Ironing Storage28

Fitting Platform29

Mirror.....29

Armoire30-31

Crafts/Cutting Table.....32-33

Cooking/Food Preparation

See Countertop section for available top series.



SUGGESTED TOP SERIES	
Series	Description
LS05_27	1 1/16" High Pressure Laminate with 3mm Edge
LS25_27	1 1/16" High Pressure Chemsurf Laminate with 3mm Edge
PS59_29	1 1/8" Solid Surface with 3R/3R Profile Edge

Cooking Extension

W	H	D
86	36	108

Peninsula Extension Only (without wall perimeter base units)
 May be used as an insert extension along a wall perimeter base cabinet run, allowing 30" gap between base units, in location required.
 Cooktop Not Included

Prep and Cooking Extension

W	H	D
86	36	108

Peninsula Extension Only (without wall perimeter base units)
 May be used as an insert extension along a wall perimeter base cabinet run, allowing 30" gap between base units, in location required.
 Sink Kit Available Separately (see below)
 Cooktop Not Included

35101

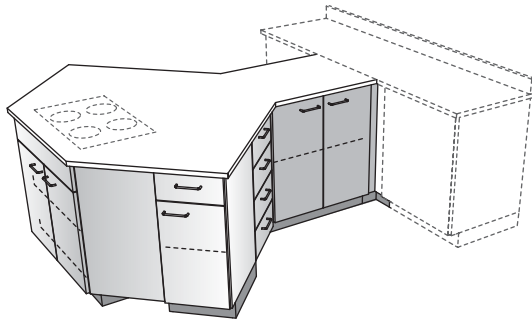

INCLUDES:

- | | W | H | D |
|---|----|----|----|
| (1) 10486 | 36 | 35 | 24 |
| 6 1/8" H False Front Doors
Rollout Shelves
Accommodates 30" Cooktop Appliance | | | |
| (1) 10421 | 15 | 35 | 21 |
| Drawer: 6 1/8" H Front Right Hinge Door
Adjustable Shelf | | | |
| (1) 10422 | 15 | 35 | 21 |
| Drawer: 6 1/8" H Front Left Hinge Door
Adjustable Shelf | | | |
| (2) 10370 | 18 | 35 | 18 |
| 4 Equal Drawers | | | |
| (1) 10129 | 30 | 35 | 24 |
| Doors
Adjustable Shelf | | | |

35103

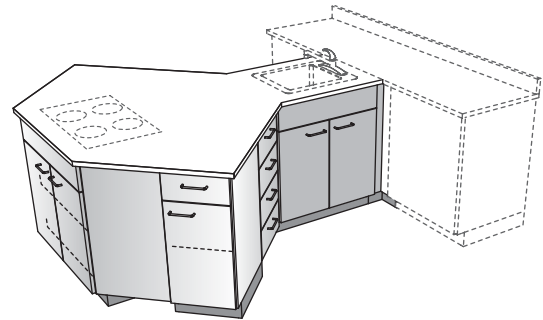

INCLUDES:

- | | W | H | D |
|---|----|----|----|
| (1) 10486 | 36 | 35 | 24 |
| 6 1/8" H False Front Doors
Rollout Shelves
Accommodates 30" Cooktop Appliance | | | |
| (1) 10421 | 15 | 35 | 21 |
| Drawer: 6 1/8" H Front Right Hinge Door
Adjustable Shelf | | | |
| (1) 10422 | 15 | 35 | 21 |
| Drawer: 6 1/8" H Front Left Hinge Door
Adjustable Shelf | | | |
| (2) 10370 | 18 | 35 | 18 |
| 4 Equal Drawers | | | |
| (1) 10479 | 30 | 35 | 24 |
| 6 1/8" H False Front Doors | | | |

Available Separately:

- | | |
|--------------|----------------------------|
| 35600 | Sink Kit |
| 52SL17519AGR | Stainless Steel Sink |
| 52J35 | Strainer |
| 52311 H & C | Single Lever Chrome Faucet |

SUGGESTED TOP SERIES	
Series	Description
LS05_27	1½" High Pressure Laminate with 3mm Edge
LS25_27	1½" High Pressure Chemsurf Laminate with 3mm Edge
PS59_29	1½" Solid Surface with 3R/3R Profile Edge

Food Prep Extension

W	H	D
86	36	112

GFI Receptacle (field cut and installed)
Peninsula Extension Only
(without wall perimeter base units)
May be used as an insert extension along a wall perimeter base cabinet run, allowing 30" gap between base units, in location required.

Food Prep Extension



W	H	D
86	36	112

GFI Receptacle (field cut and installed)
Peninsula Extension Only
(without wall perimeter base units)
May be used as an insert extension along a wall perimeter base cabinet run, allowing 30" gap between base units, in location required.
Sink Kit Available Separately (see below)

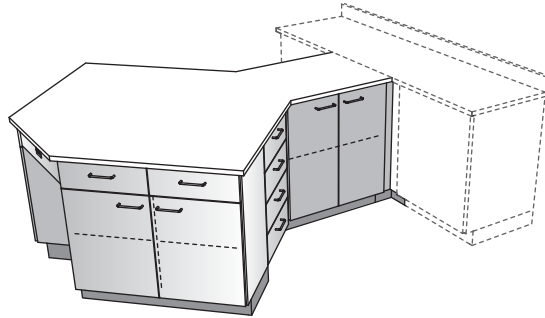
35121





INCLUDES:

	W	H	D
 (2) 10441	39	35	18
2 Drawers: 6½"H Fronts Doors Center Divider Adjustable Shelves			
 (2) 10370	21	35	18
4 Equal Drawers			
 (1) 10129	30	35	24
Doors Adjustable Shelf			

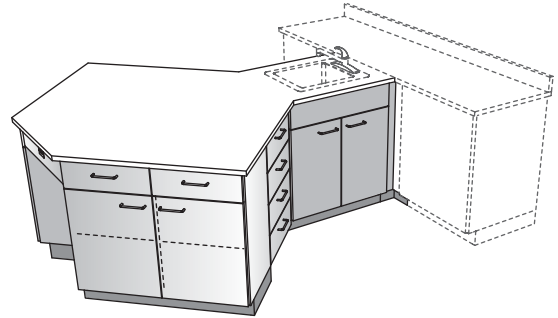
35123



INCLUDES:

	W	H	D
 (2) 10441	39	35	18
2 Drawers: 6½"H Fronts Doors Center Divider Adjustable Shelves			
 (2) 10370	21	35	18
4 Equal Drawers			
 (1) 10479	30	35	24
6½"H False Front Doors			

Available Separately:

35600	Sink Kit
	52SL17519AGR
	Stainless Steel Sink
	52J35 Strainer
	52311 H & C Single
	Lever Chrome Faucet

HOME ARTS – CULINARY

Demonstration Island

See Countertop section for available top series.



SUGGESTED TOP SERIES	
Series	Description
LS05_27	1 1/16" High Pressure Laminate with 3mm Edge
LS25_27	1 1/16" High Pressure Chemsurf Laminate with 3mm Edge
PS59_29	1 1/8" Solid Surface with 3R/3R Profile Edge

Demonstration Island (Prep and Baking)

W H D
86 36 30

GFI Receptacle (field cut and installed)
Sink Kit and Mirror Available Separately
(see below)

Demonstration Island (Prep and Baking)

W H D
86 36 30

GFI Receptacle (field cut and installed)
Sink Kit and Mirror Available Separately
(see below)

35140

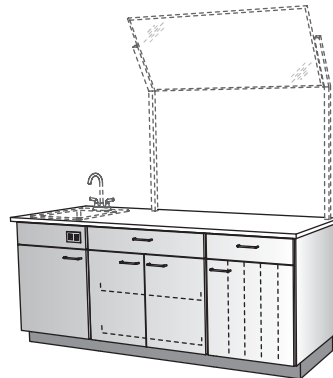

INCLUDES:

- | | W | H | D |
|-----------|---|----------|----------|
| (1) 35183 | 24 | 35 | 28 |
| | 6 1/8" H False Front
Left Hinge Door | | |
| (1) 35185 | 36 | 35 | 28 |
| | Drawer: 6 1/8" H Front
Doors
Rollout Shelves | | |
| (1) 35187 | 24 | 35 | 28 |
| | Drawer: 6 1/8" H Front
Right Hinge Door
1/4" Adjustable and Removable
Vertical Dividers
5 Vertical Compartments | | |
| (2) 10868 | Overlay Finished
Backs | | |

Available Separately:

- | | |
|-------|---|
| 35600 | Sink Kit |
| | 52SL17519AGR
Stainless Steel Sink |
| | 52J35 Strainer |
| | 52311 H & C Single
Lever Chrome Faucet |
| 10960 | 59 76 26
Demonstration Mirror |

35141

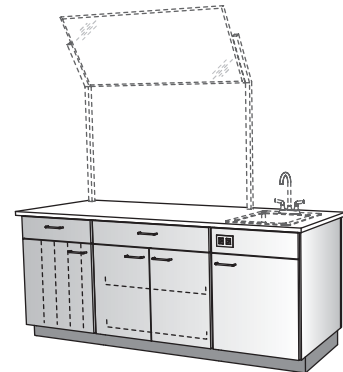

INCLUDES:

- | | W | H | D |
|-----------|--|----------|----------|
| (1) 35188 | 24 | 35 | 28 |
| | Drawer: 6 1/8" H Front
Left Hinge Door
1/4" Adjustable and Removable
Vertical Dividers
5 Vertical Compartments | | |
| (1) 35185 | 36 | 35 | 28 |
| | Drawer: 6 1/8" H Front
Doors
Rollout Shelves | | |
| (1) 35182 | 24 | 35 | 28 |
| | 6 1/8" H False Front
Right Hinge Door | | |
| (2) 10868 | Overlay Finished
Backs | | |

Available Separately:

- | | |
|-------|---|
| 35600 | Sink Kit |
| | 52SL17519AGR
Stainless Steel Sink |
| | 52J35 Strainer |
| | 52311 H & C Single
Lever Chrome Faucet |
| 10960 | 59 76 26
Demonstration Mirror |



Demonstration Island

See Countertop section for available top series.

SUGGESTED TOP SERIES	
Series	Description
LS05_27	1 1/16" High Pressure Laminate with 3mm Edge
LS25_27	1 1/16" High Pressure Chemsurf Laminate with 3mm Edge
PS59_29	1 1/8" Solid Surface with 3R/3R Profile Edge

Demonstration Island (Prep and Baking)

W H D
98 36 30

GFI Receptacle (field cut and installed)
Sink Kit and Mirror Available Separately
(see below)

Demonstration Island (Prep and Baking)



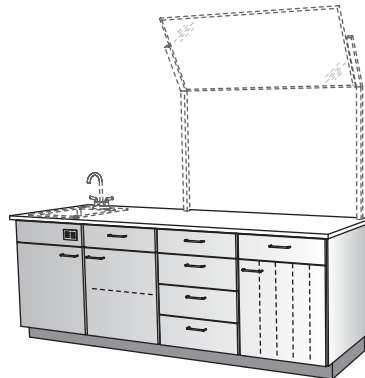

W H D
98 36 30

GFI Receptacle (field cut and installed)
Sink Kit and Mirror Available Separately
(see below)

35142



INCLUDES:

- | | W | H | D |
|---|---|----|----|
|  (1) 35183 | 24 | 35 | 28 |
| | 6 1/8" H False Front
Left Hinge Door | | |
|  (1) 35180 | 24 | 35 | 28 |
| | Drawer: 6 1/8" H Front
Right Hinge Door
Adjustable Shelf | | |
|  (1) 35189 | 24 | 35 | 28 |
| | Top Drawer: 6 1/8" H Front
3 Equal Drawers | | |
|  (1) 35187 | 24 | 35 | 28 |
| | Drawer: 6 1/8" H Front
Right Hinge Door
1/4" Adjustable and Removable
Vertical Dividers
5 Vertical Compartments | | |
| (2) 10868 | Overlay Finished Backs | | |



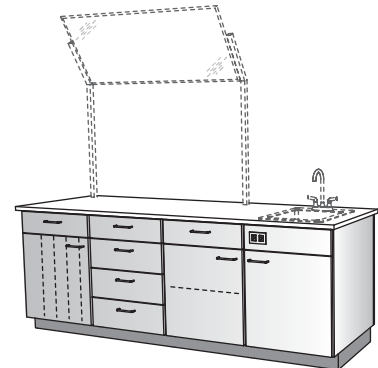

Available Separately:

- | | |
|--------------|----------------------------------|
| 35600 | Sink Kit |
| 52SL17519AGR | Stainless Steel Sink |
| 52J35 | Strainer |
| 52311 H & C | Single Lever Chrome Faucet |
| 10960 | 59 76 26
Demonstration Mirror |

35143



INCLUDES:

- | | W | H | D |
|---|--|----|----|
|  (1) 35188 | 24 | 35 | 28 |
| | Drawer: 6 1/8" H Front
Left Hinge Door
1/4" Adjustable and Removable
Vertical Dividers
5 Vertical Compartments | | |
|  (1) 35189 | 24 | 35 | 28 |
| | Top Drawer: 6 1/8" H Front
3 Equal Drawers | | |
|  (1) 35181 | 24 | 35 | 28 |
| | Drawer: 6 1/8" H Front
Left Hinge Door
Adjustable Shelf | | |
|  (1) 35182 | 24 | 35 | 28 |
| | 6 1/8" H False Front
Right Hinge Door | | |
| (2) 10868 | Overlay Finished Backs | | |

Available Separately:

- | | |
|--------------|----------------------------------|
| 35600 | Sink Kit |
| 52SL17519AGR | Stainless Steel Sink |
| 52J35 | Strainer |
| 52311 H & C | Single Lever Chrome Faucet |
| 10960 | 59 76 26
Demonstration Mirror |

HOME ARTS – CULINARY

Demonstration Island

See Countertop section for available top series.



SUGGESTED TOP SERIES	
Series	Description
LS05_27	1 1/16" High Pressure Laminate with 3mm Edge
LS25_27	1 1/16" High Pressure Chemsurf Laminate with 3mm Edge
PS59_29	1 1/8" Solid Surface with 3R/3R Profile Edge

Demonstration Island (Cooking)

W H D
98 36 30

GFI Receptacle (field cut and installed)
Sink Kit and Mirror Available Separately (see below)
Cooktop Not Included

Demonstration Island (Cooking)



W H D
98 36 30

GFI Receptacle (field cut and installed)
Sink Kit and Mirror Available Separately (see below)
Cooktop Not Included

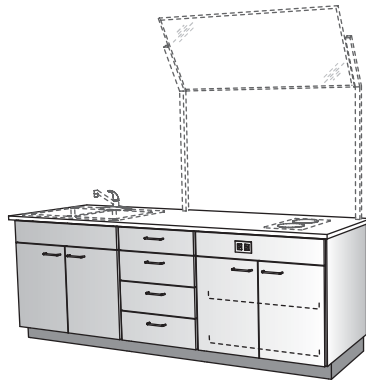
35144



INCLUDES:

- | | W | H | D |
|---|---|----------|----------|
|  (1) 35184 | 36 | 35 | 28 |
| | 6 1/8" H False Front Doors | | |
|  (1) 35189 | 24 | 35 | 28 |
| | Top Drawer: 6 1/8" H Front
3 Equal Drawers | | |
|  (1) 35186 | 36 | 35 | 28 |
| | 6 1/8" H False Front Doors
Rollout Shelves
Accommodates 30" Cooktop Appliance | | |
| (2) 10868 | Overlay Finished Backs | | |



Available Separately:

- | | |
|-------|--|
| 35601 | Sink Kit
52DL1829AGR
Stainless Steel Sink
52J35 Strainer
52311 H & C Single
Lever Chrome Faucet |
| 10960 | 59 76 26
Demonstration Mirror |

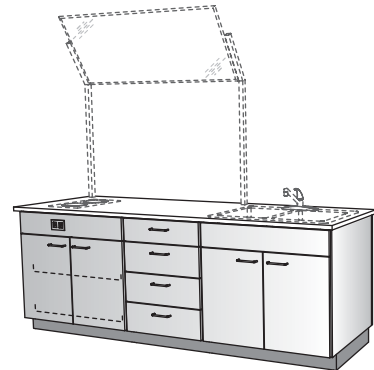
35145



INCLUDES:

- | | W | H | D |
|---|---|----------|----------|
|  (1) 35186 | 36 | 35 | 28 |
| | 6 1/8" H False Front Doors
Rollout Shelves
Accommodates 30" Cooktop Appliance | | |
|  (1) 35189 | 24 | 35 | 28 |
| | Top Drawer: 6 1/8" H Front
3 Equal Drawers | | |
|  (1) 35184 | 36 | 35 | 28 |
| | 6 1/8" H False Front Doors | | |
| (2) 10868 | Overlay Finished Backs | | |

Available Separately:

- | | |
|-------|--|
| 35601 | Sink Kit
52DL1829AGR
Stainless Steel Sink
52J35 Strainer
52311 H & C Single
Lever Chrome Faucet |
| 10960 | 59 76 26
Demonstration Mirror |

Demonstration Island

See Countertop section for available top series.

SUGGESTED TOP SERIES	
Series	Description
LS05_27	1½" High Pressure Laminate with 3mm Edge
LS25_27	1½" High Pressure Chemsurf Laminate with 3mm Edge
PS59_29	1½" Solid Surface with 3R/3R Profile Edge

Demonstration Island

W H D
98 36 30

Sink Kit and Mirror Available Separately (see below)

Demonstration Island



W H D
98 36 30

Sink Kit and Mirror Available Separately (see below)

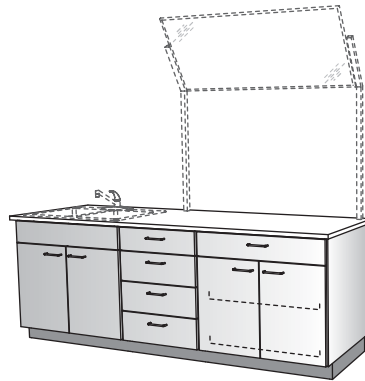
35146



INCLUDES:

- | | W | H | D |
|---|--|----------|----------|
|  (1) 35184 | 36 | 35 | 28 |
| | 6½"H False Front Doors | | |
|  (1) 35189 | 24 | 35 | 28 |
| | Top Drawer: 6½"H Front 3 Equal Drawers | | |
|  (1) 35185 | 36 | 35 | 28 |
| | Drawer: 6½"H Front Doors Rollout Shelves | | |
| (2) 10868 | Overlay Finished Backs | | |



Available Separately:

- | | |
|-------|--|
| 35601 | Sink Kit |
| | 52DL1829AGR |
| | Stainless Steel Sink |
| | 52J35 Strainer |
| | 52311 H & C Single Lever Chrome Faucet |
| 10960 | 59 76 26 |
| | Demonstration Mirror |

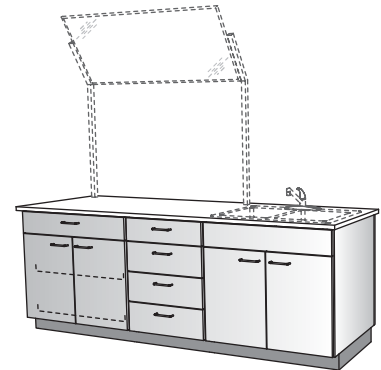
35147



INCLUDES:

- | | W | H | D |
|---|--|----------|----------|
|  (1) 35185 | 36 | 35 | 28 |
| | Drawer: 6½"H Front Doors Rollout Shelves | | |
|  (1) 35189 | 24 | 35 | 28 |
| | Top Drawer: 6½"H Front 3 Equal Drawers | | |
|  (1) 35184 | 36 | 35 | 28 |
| | 6½"H False Front Doors | | |
| (2) 10868 | Overlay Finished Backs | | |

Available Separately:

- | | |
|-------|--|
| 35601 | Sink Kit |
| | 52DL1829AGR |
| | Stainless Steel Sink |
| | 52J35 Strainer |
| | 52311 H & C Single Lever Chrome Faucet |
| 10960 | 59 76 26 |
| | Demonstration Mirror |

HOME ARTS – CULINARY

Demonstration Island Base

6 1/8" H drawer fronts align with other noted 6 1/8" H drawer and false fronts.



				Storage			
W	H	D		W	H	D	
12	32	23		12	32	23	
15	35	24		15	35	24	
18		28		18		28	
21		29		21		29	
24				24			
Right Hinge Door Adjustable Shelf				Left Hinge Door Adjustable Shelf			
				Doors Adjustable Shelf			
				Drawer: 6 1/8" H Front Right Hinge Door Adjustable Shelf			
				Drawer: 6 1/8" H Front Left Hinge Door Adjustable Shelf			
35194				35195			
				35196			
				35180			
				35181			

				Storage				Drawer							
W	H	D		W	H	D		W	H	D		W	H	D	
24	32	23		30	32	23		15	27	32	23	30	32	23	
27	35	24		33	35	24		18	30	35	24	36	35	24	
30		28		36		28		21	33	28				28	
33		29				29		24	36	29				29	
Drawer: 6 1/8" H Front Doors Adjustable Shelf				Drawers: 6 1/8" H Fronts Doors Center Divider Adjustable Shelves				Top Drawer: 6 1/8" H Front 2 Equal Drawers				Top Drawer: 6 1/8" H Front 3 Equal Drawers			
												Top Drawers: 6 1/8" H Fronts 3 Equal Drawers			
35197				35198				35190				35189			

Demonstration Island Base

6 1/8" H drawer fronts and false fronts align with other noted 6 1/8" H drawer and false fronts.

Pan Storage

W	H	D
24	32	23
27	35	24
30		28
33		29
36		

Drawer: 6 1/8" H Front
Doors
Rollout Shelves

35185

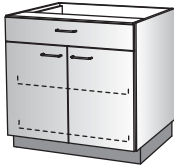

Cooktop

W	H	D
36	32	23
	35	24
		28
		29

6 1/8" H False Front
Doors
Rollout Shelves

35186

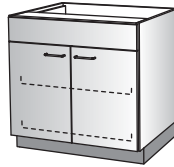

Tray Storage

W	H	D
15	32	23
18	35	24
21		28
24		29

Drawer: 6 1/8" H Front
Left Hinge Door
1/4" Adjustable and
Removable Vertical Dividers

35188



Number of Compartments	W	H	D	
	4	15	32	23
	4	18	35	24
	5	21		28
	5	24		29

Drawer: 6 1/8" H Front
Right Hinge Door
1/4" Adjustable and
Removable Vertical Dividers

35187



Sink Base

W	H	D
18	32	23
21	35	24
24		28
		29

6 1/8" H False Front
Right Hinge Door

35182



W	H	D
18	32	23
21	35	24
24		28
		29

6 1/8" H False Front
Left Hinge Door

35183



W	H	D
30	32	23
33	35	24
36		28
		29

6 1/8" H False Front
Doors

35184



HOME ARTS – CULINARY

Desk Extension

See Countertop section for available top series.



SUGGESTED TOP SERIES	
Series	Description
LS05_27	1 1/16" High Pressure Laminate with 3mm Edge
LS25_27	1 1/16" High Pressure Chemsurf Laminate with 3mm Edge
PS59_29	1 1/8" Solid Surface with 3R/3R Profile Edge

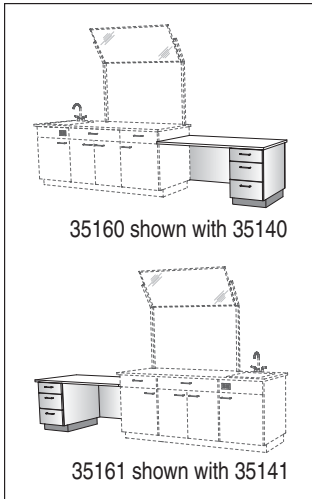

Teacher Desk Extension		
W	H	D
48	30	30
60		
Attaches to Demonstration Islands		
35160		

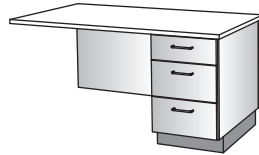

INCLUDES:

- | | W | H | D |
|---|---|----|----|
|  (1) 35190 | 18 | 29 | 28 |
| | Top Drawer: 6 1/8" H Front
2 Equal Drawers | | |
| (1) 10956 | Overlay Finished Back | | |
| (1) 10952 | Modesty Panel | | |

Teacher Desk Extension		
W	H	D
48	30	30
60		
Attaches to Demonstration Islands		
35161		

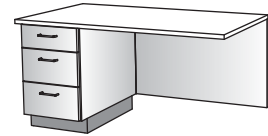

INCLUDES:

- | | W | H | D |
|---|---|----|----|
|  (1) 35190 | 18 | 29 | 28 |
| | Top Drawer: 6 1/8" H Front
2 Equal Drawers | | |
| (1) 10956 | Overlay Finished Back | | |
| (1) 10952 | Modesty Panel | | |

SUGGESTED TOP SERIES	
Series	Description
LS05_27	1 1/16" High Pressure Laminate with 3mm Edge
LS25_27	1 1/16" High Pressure Chemsurf Laminate with 3mm Edge
PS59_29	1 1/8" Solid Surface with 3R/3R Profile Edge

Teacher Desk Extension		
W	H	D
48	30	30
60		
Attaches to Demonstration Islands		
35162		



INCLUDES:



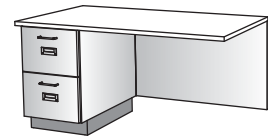

- | | W | H | D |
|---|-------------------------------|----|----|
|  (1) 35191 | 18 | 29 | 28 |
| | 2 Full Extension File Drawers | | |
| (1) 10956 | Overlay Finished Back | | |
| (1) 10952 | Modesty Panel | | |



Teacher Desk Extension		
W	H	D
48	30	30
60		
Attaches to Demonstration Islands		
35163		



INCLUDES:

- | | W | H | D |
|---|-------------------------------|----|----|
|  (1) 35191 | 18 | 29 | 28 |
| | 2 Full Extension File Drawers | | |
| (1) 10956 | Overlay Finished Back | | |
| (1) 10952 | Modesty Panel | | |

									Drawer		
W	H	D	W	H	D	W	H	D	W	H	D
15	29	23	15	29	23	30	29	23	15	29	23
18		24	18		24	36		24	18		24
		28			28			28			28
		29			29			29			29
Top Drawer: 6 1/8"H Front 2 Equal Drawers			2 Full Extension File Drawers			2 Full Extension Lateral Files Divider for Side Filing of Letter/Legal Files			2 Drawers Full Extension File Drawer		
35190			35191			35192			35193		
											

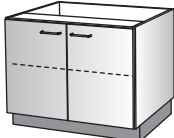
									Storage		
W	H	D	W	H	D	W	H	D	W	H	D
15	29	23	15	29	23	15	29	23	30	29	23
18		24	18		24	18		24	36		24
		28			28			28			28
		29			29			29			29
Right Hinge Door Adjustable Shelf			Right Hinge Door Adjustable Shelf			Left Hinge Door Adjustable Shelf			Doors Adjustable Shelf		
35194			35195			35195			35196		
											

HOME ARTS – CULINARY

Demonstration Mobile

Demonstration mobiles with mirror are designed to roll through a standard 6'8" doorway.



W H D
48 36 24
29

Demonstration Mirror
Left Hinge Door
Adjustable Shelf
3 Equal Drawers

60733

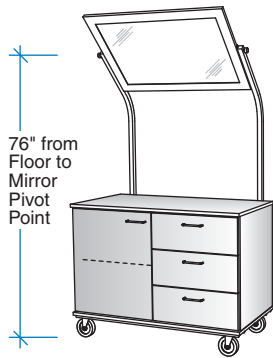

W H D
48 36 24
29

Demonstration Mirror
Sink with Galley Pump
Left Hinge Door
2 Jericans
3 Equal Drawers

60740

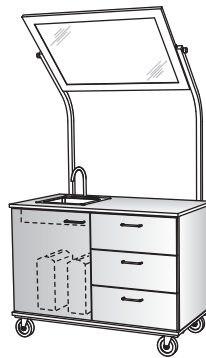

W H D
59 36 24
29

Demonstration Mirror
Doors
Adjustable Shelves
4 Equal Drawers

60729



W H D
59 36 24
29

Demonstration Mirror
Sink with Galley Pump
Doors
Adjustable Shelf
2 Jericans
3 Equal Drawers

60742



W H D
59 36 24
29

Demonstration Mirror
Sink with Galley Pump
2-Burner Cooktop
Doors
2 Jericans
Adjustable Shelf
4 Equal Drawers

60730

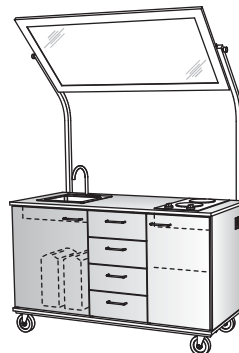

W H D
48 36 24
29

Demonstration Mirror
Sink with Galley Pump
Doors
Adjustable Shelf
2 Jericans

60744

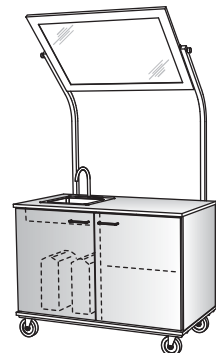

6 1/8" H false fronts align with other noted 6 1/8" H drawer and false fronts.

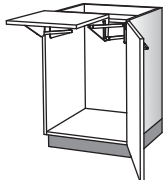
Mixing Cabinet			
W	H	D	
15	35	24	
18			
21			
24			
Right Hinge Door Lift-Up Platform Shelf			
10483			
			

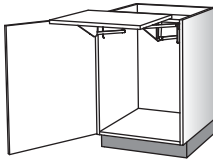
Mixing Cabinet			
W	H	D	
15	35	24	
18			
21			
24			
Left Hinge Door Lift-Up Platform Shelf			
10484			
			

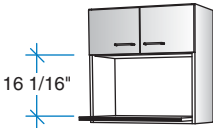
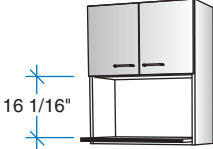
Microwave Cabinet			
W	H	D	
27	30	14	
30	36	18	
33			
36			
Microwave Cabinet 20"-Deep Attachable Microwave Shelf Accommodates Typical 1 cu.ft. - 2 cu.ft. Microwave			
15149			
			
30H			
			
36H			

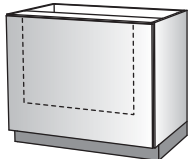
Drop-In-Range Enclosure			
W	H	D	
36	32	24	
42	35		
Field Cut Front Panel for Appliance			
10485			
			

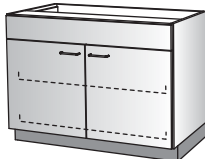
Cooktop Unit			
W	H	D	
36	32	24	
42	35		
48			
6 1/8" H False Front Doors Rollout Shelves			
10486			
			

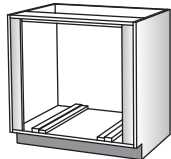
Under-Counter Oven Cabinet			
W	H	D	
30	35	24	
33		29	
36			
Finished Ends Open Back 30W/33W: For 27W/30W Oven and 30W Cooktop 36W: For 30W Oven and 36W Cooktop (2) pair removable bottom rails to accommodate standard oven heights, as required (1) pair removable vertical side rails to accommodate standard oven widths, as required			
10482			
			

Single Oven Cabinet

W H D
30 84 24
33
36

Upper Doors
2 Lower Drawers
Open Back
Field Cut Front Panel for Appliance

25635

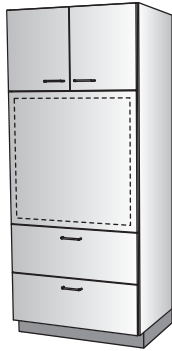

Single Oven Cabinet

W H D
30 84 24
33
36

Upper Doors
Lower Doors
Lower Adjustable Shelf
Open Back
Field Cut Front Panel for Appliance

25638

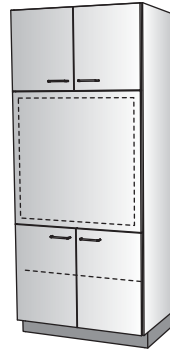

Double Oven Cabinet

W H D
30 84 24
33
36

Upper Doors
Lower Drawer
Open Back
Field Cut Front Panel for Appliances

25639



Oven/Microwave Cabinet

W H D
30 84 24
33
36

Designed to Accommodate
Both Oven and Microwave
Upper Doors
Lower Drawer
Open Back
Field Cut Front Panel for Appliances

25621

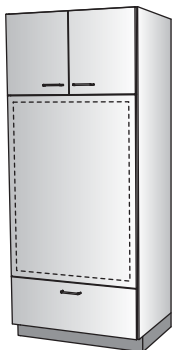

ADA Single Oven Cabinet

W H D
30 84 24
33
36



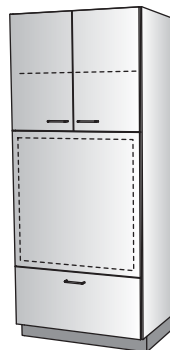

Upper Doors
Adjustable Shelf
Lower Drawer
Open Back
Field Cut Front Panel for Appliance

25634



6 1/8" H drawer fronts align with other noted 6 1/8" H drawer and false fronts.



Vegetable Storage

W H D	W H D	W H D	W H D
15 32 24 35	15 32 24 35	15 35 24	15 35 24
Right Hinge Door 3 Pullout Wire Baskets (8 5/8"W x 4 1/2"H x 19 1/4"D)	Left Hinge Door 3 Pullout Wire Baskets (8 5/8"W x 4 1/2"H x 19 1/4"D)	Drawer: 6 1/8" H Front Right Hinge Door 3 Pullout Wire Baskets (8 5/8"W x 4 1/2"H x 19 1/4"D)	Drawer: 6 1/8" H Front Left Hinge Door 3 Pullout Wire Baskets (8 5/8"W x 4 1/2"H x 19 1/4"D)
10456	10457	10458	10459
			

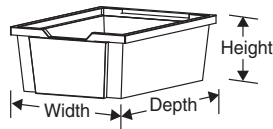
Molded translucent bins:
SA911: 12 1/4 W x 6 H x 16 3/4 D

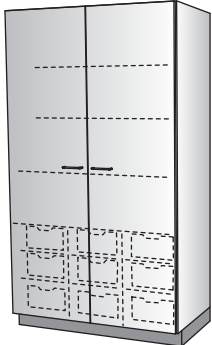

Food Staples

W H D	W H D	W H D	W H D
18 84 24	18 84 24	30 84 24 33 36	42 84 24 45 48
Right Hinge Door Half-Depth Adjustable Shelves Adjustable Shelves (3) SA911 Bins	Left Hinge Door Half-Depth Adjustable Shelves Adjustable Shelves (3) SA911 Bins	Doors Half-Depth Adjustable Shelves Adjustable Shelves (6) SA911 Bins	Doors Half-Depth Adjustable Shelves Adjustable Shelves (9) SA911 Bins
25480	25481	25482	25483
			

Pan/Tray Storage

6 1/8" H drawer fronts align with other noted 6 1/8" H drawer and false fronts.

Pan Storage

W	H	D
18	35	24
21		29
24		

Drawer: 6 1/8" H Front
Right Hinge Door
Rollout Shelves

10408



W	H	D
18	35	24
21		29
24		

Drawer: 6 1/8" H Front
Left Hinge Door
Rollout Shelves

10409



W	H	D
30	42	29
33	45	32
36	48	35
39		

Doors
Full Extension Rollout Shelves

10492

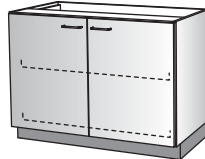

W	H	D
24	29	24
27	32	29
30	35	
33		
36		

Drawer: 6 1/8" H Front
Doors
Rollout Shelves

10494



W	H	D
39	29	24
42	32	29
45	35	
48		

Drawers: 6 1/8" H Fronts
Doors
Rollout Shelves
Not for use with stone-type tops

10495



Tray Storage

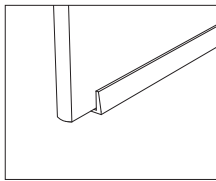

1/4"-thick vertical dividers are held securely with translucent, low profile supports.

Number of Compartments	W	H	D
4	15	32	18
4	18	35	21
5	21	24	24
5	24	29	29

Drawer: 6 1/8" H Front
Right Hinge Door
1/4" Adjustable and Removable Vertical Dividers

10659

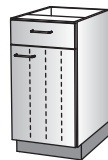

W	H	D
15	32	18
18	35	21
21	24	24
24	29	29

Drawer: 6 1/8" H Front
Left Hinge Door
1/4" Adjustable and Removable Vertical Dividers

10658

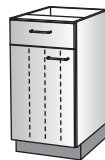

W	H	D
15	29	18
18	32	21
21	35	24
24	29	29

Right Hinge Door
1/4" Adjustable and Removable Vertical Dividers

10665



W	H	D
15	29	18
18	32	21
21	35	24
24	29	29

Left Hinge Door
1/4" Adjustable and Removable Vertical Dividers

10666

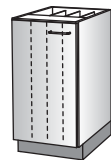

Broom/Utility Storage

W H D
18 84 24
21 29
24

Right Hinge Door
Center Divider
Left: Hooks
Right: Adjustable Shelves

W H D
18 84 24
21 29
24

Left Hinge Door
Center Divider
Left: Adjustable Shelves
Right: Hooks

W H D
36 84 24
42 29
48

Doors
Right: Hooks
Left: Adjustable Shelves

25636



25637



25640

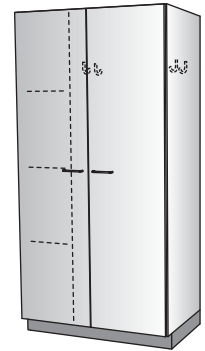

Pantry

W H D
18 84 24
21 21
24

Right Hinge Door
Half-Depth and Full-Depth
Adjustable Shelves
Rollout Shelves

W H D
18 84 24
21 21
24

Left Hinge Door
Half-Depth and Full-Depth
Adjustable Shelves
Rollout Shelves

25488



25489



Above Refrigerator

W	H	D
30	12	14
33	16	18
36	18	24
39		

W	H	D
30	12	14
33	16	18
36	18	24
39		

Refrigerator Enclosure Panel

W	H	D
00	84	14
		18
		24

15102

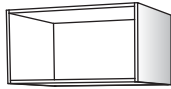

15103



25840



REFRIGERATOR SIZING GUIDELINES

12H Above Refrigerator Cabinet

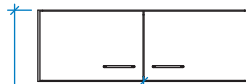

84"
overall height

72"
(1829mm)
vertical space
available for
refrigerator

16H Above Refrigerator Cabinet



74.5"
(1893mm)
vertical space
available for
refrigerator

18H Above Refrigerator Cabinet

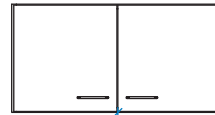

72"
(1829mm)
vertical space
available for
refrigerator

90"
overall height

14D/18D Above Refrigerator Cabinet mounting is the same as that of standard wall cabinets.

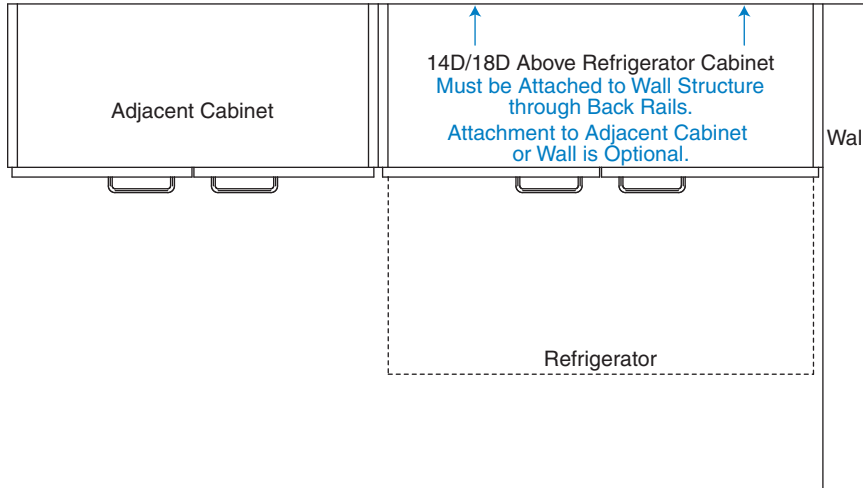

**MOUNTING
REQUIREMENTS
FOR 14D/18D
ABOVE REFRIGERATOR
CABINETS**

If located against wall, 24D Above Refrigerator Cabinet must be attached through end panels to adjacent wall and adjacent cabinet.

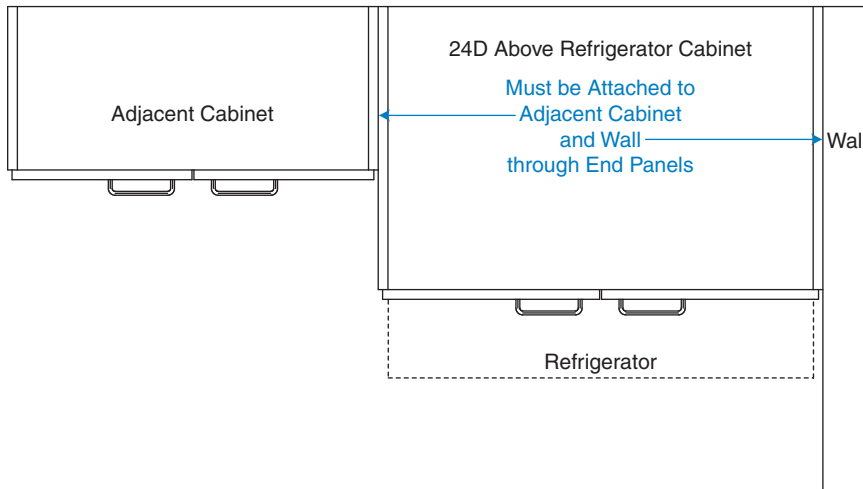

**MOUNTING
REQUIREMENTS
FOR 24D
ABOVE REFRIGERATOR
CABINETS**

If open ended, 24D Above Refrigerator Cabinet must be attached to adjacent cabinet and 25840 Refrigerator Enclosure Panel adjacent to cabinet end.

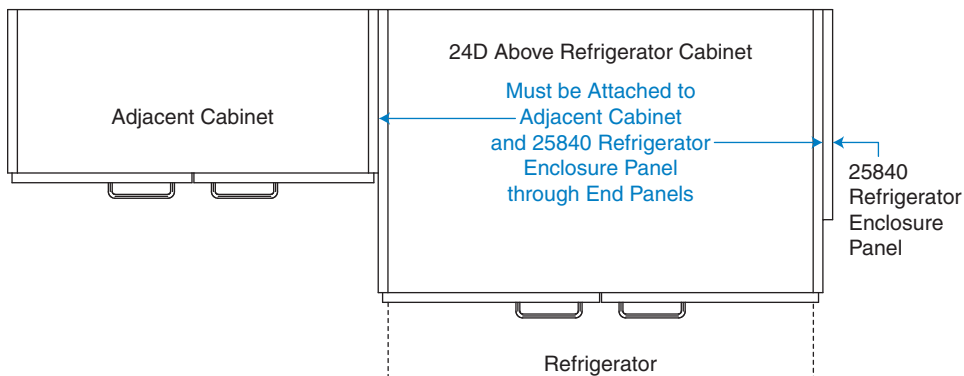

Recycling/Waste Bin

6 1/8" H drawer fronts align with other noted 6 1/8" H drawer and false fronts.

Recycling/Waste Bin - Pullout Door

W	H	D	W	H	D	W	H	D
15	32	24	18	32	24	18	35	24
	35			35				
Pullout Door Pullout Trash Bin (50 qt.)			Pullout Door 2 Pullout Trash Bins (35 qt. each)			Drawer: 6 1/8" H Front Pullout Door 2 Pullout Trash Bins (35 qt. each)		

10694

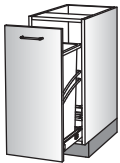

10695

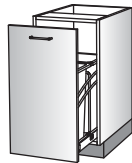

10696

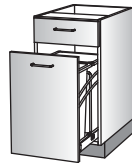

Recycling/Waste Bin - Hinge Door

W	H	D	W	H	D	W	H	D	W	H	D	W	H	D			
15	32	24	15	32	24	18	32	24	18	32	24	18	35	24			
	35			35			35			35							
Right Hinge Door Pullout Trash Bin (50 qt.)			Left Hinge Door Pullout Trash Bin (50 qt.)			Right Hinge Door 2 Pullout Trash Bins (35 qt. each)			Left Hinge Door 2 Pullout Trash Bins (35 qt. each)			Drawer: 6 1/8" H Front Right Hinge Door 2 Pullout Trash Bins (35 qt. each)			Drawer: 6 1/8" H Front Left Hinge Door 2 Pullout Trash Bins (35 qt. each)		

10688

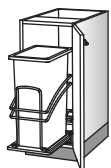

10689

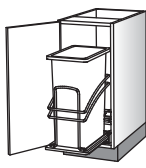

10690

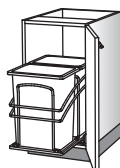

10691

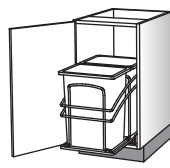

10692



10693

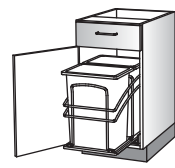

Smock Storage

W H D
24 84 24

Right Hinge Door
Fixed Shelf
14 Hooks

25611



W H D
24 84 24

Left Hinge Door
Fixed Shelf
14 Hooks

25612



W H D
36 84 24
48

Doors
Fixed Shelf
36W = 21 Hooks
48W = 28 Hooks

25613

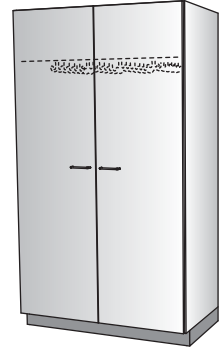

Linen Storage

W H D
18 84 24

Right Hinge Door
Ventilation Grilles
Wire Shelves

25630



W H D
18 84 24

Left Hinge Door
Ventilation Grilles
Wire Shelves

25631



W H D
48 84 24

Doors
Ventilation Grilles
Wire Shelves

25632

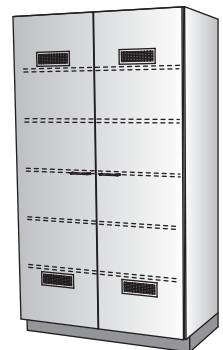

HOME ARTS – CULINARY

Towel/Clothing Storage

6 1/8" H drawer fronts align with other noted 6 1/8" H drawer and false fronts.



Pullout Hamper

W H D
18 35 24
21

Drawer: 6 1/8" H Front
Pullout Door
Pullout Hamper

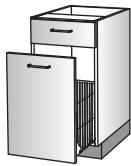

10656

Towel Storage

W H D
12 35 24
15

Right Hinge Door
Ventilation Grilles
Pullout Towel Rack



10454

W H D
12 35 24
15

Left Hinge Door
Ventilation Grilles
Pullout Towel Rack



10455

Clothing Storage

W H D
24 84 24

Right Hinge Door
Pullout Clothes Bars
Fixed Shelf



25584

W H D
24 84 24

Left Hinge Door
Pullout Clothes Bars
Fixed Shelf

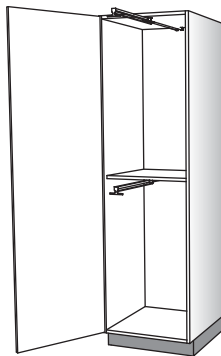

25585

W H D
24 84 24

Right Hinge Door
Pullout Clothes Bar
Fixed Shelf

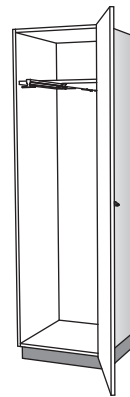

25586

W H D
24 84 24

Left Hinge Door
Pullout Clothes Bar
Fixed Shelf

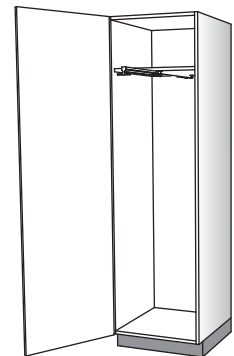

25587

Ceiling Mount Demonstration Mirror

	W	H	D
Mirror	47"	48	Varies
Frame	58"	59	26
	71"	72	

12" Adjustment to Accommodate Ceiling Height
Ceiling Mounted with 1/2" Threaded Rods
(included)

10959

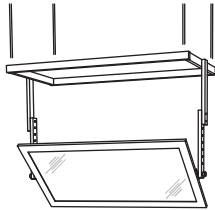

Movable Ceiling Mount Demonstration Mirror

	W	H	D
Mirror	47"	48	Varies
Frame	58"	59	28
	71"	72	

Track Length = 96"
12" Adjustment to Accommodate Ceiling Height
Ceiling Mounted with 1/2" Threaded Rods
(included)

10958

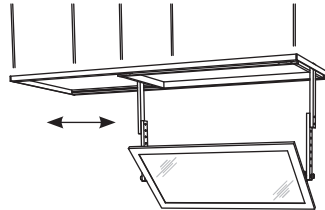

Motorized Visual Aid Mirror

	W	H	D
Mirror	67"	Varies	26
Frame			

Ceiling Mounted with 1/2" Threaded Rods
(included)
67" x 26" Framed Mirror
Motorized 110V Tilt with Power Remote

10961

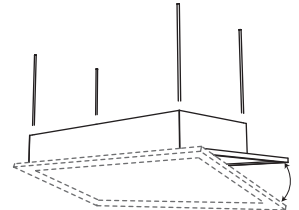

Demonstration Mirror

	W	H	D
Mirror	43"	48	76
Frame	54"	59	26
	67"	72	

W = Cabinet Width
76H = Distance from Floor
to Mirror Pivot

10960

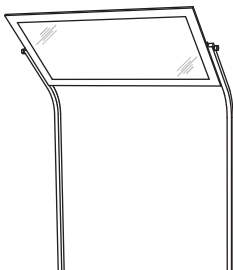

Sliding Towel Bar

W	H	D
05	02	18

Side Mounts to Cabinet
(left or right)
3 Towel Bars
Anochrome Finish

10902

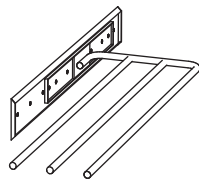

Clothing Carrier

W	H	D
02	02	10
		12
		16
		20

Mounts Under
Closet Shelves
Anochrome Finish

10903

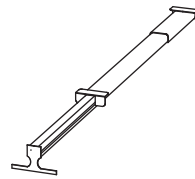

Sink Kit

Includes:
52SL17519AGR
Custom Single Bowl
Stainless Steel Sink
52J35
Stainless Steel Strainer
52311
Chrome H & C
Single Lever Faucet

35600

Applicable for:
35103 Prep and Cooking
Extension
35123 Food Prep Extension
35140 Demonstration Island
35141 Demonstration Island
35142 Demonstration Island
35143 Demonstration Island

See Accessories section
for details

Includes:
52DL1829AGR
Custom Double Bowl
Stainless Steel Sink
52J35
Stainless Steel Strainer
52311
Chrome H & C
Single Lever Faucet

35601

Applicable for:
35144 Demonstration Island
35145 Demonstration Island
35146 Demonstration Island
35147 Demonstration Island

See Accessories section
for details

Sewing Cabinet

Sewing machine not included.
Specific machine model number required for platform preparation.

SpaceSaver Sewing Cabinet – Side Seating

35004 & 35006 SpaceSaver Sewing Cabinets

The 35004 and 35006 SpaceSaver side seating sewing cabinets are designed to maximize efficient use of floor space. Machine orientation is needle-left (adjacent to the side counter). The assist lift mechanism places the sewing platform top flush with the adjacent side counter area. The entire adjacent counter surface can be used to support or provide working space for garments or projects being sewn. The total 45" dimension from the wall to the right edge of the sewing platform minimizes conflict of aisle passage and provides efficient floor space usage.

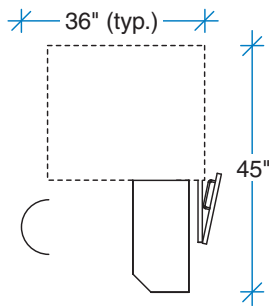

W H D
27 29 24

Flatbed Machine
Locking Doors
Needle-Left Orientation
Side Seat Position
Assist Lift
Duplex Receptacle

35004

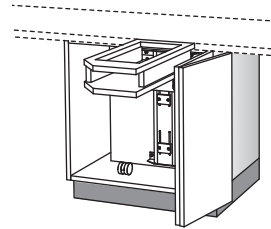

W H D
27 29 24

Free-arm Machine
Locking Doors
Needle-Left Orientation
Side Seat Position
Assist Lift
Duplex Receptacle

35006

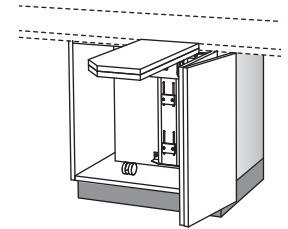

Sewing Cabinet – Front Seating

35000 & 35002 Sewing Cabinets

When front face seating is required, the 35000 and 35002 platform orientation allows for adjacent rear counter space as a convenient surface for garments or projects being sewn. Needle-left position has convenient front feed and platform extension to the left. Assist lift brings the sewing platform top flush with rear counter surface. The front orientation has seating of operator in the aisle area. Though not as space-efficient as SpaceSaver side seating, the 56" operator-to-wall dimension is a convenient usage of aisle space.

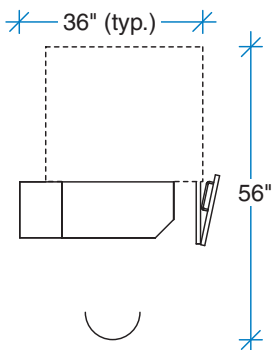

W H D
27 29 24

Flatbed Machine
Locking Doors
Needle-Left Orientation
Front Seat Position
Assist Lift
Duplex Receptacle

35000

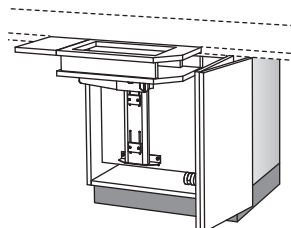

W H D
27 29 24

Free-arm Machine
Locking Doors
Needle-Left Orientation
Front Seat Position
Assist Lift
Duplex Receptacle

35002

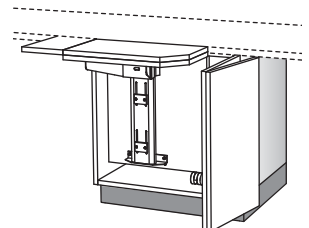

Sewing Cabinet

Sewing machine not included.
Specific machine model number required for platform preparation.

Pullout Sewing Cabinet – Side Seating

**35008 & 35010
Pullout Sewing Cabinets**

The 35008 and 35010 sewing cabinets are designed for right side operator seating. The cabinet front folds out to provide convenient sewing platform extension to the operator's left. These models provide solutions for both flatbed and free-arm machines with convenient assist lifts. The 67" total extension from the wall when in use requires adequate floor area and aisle clearances.

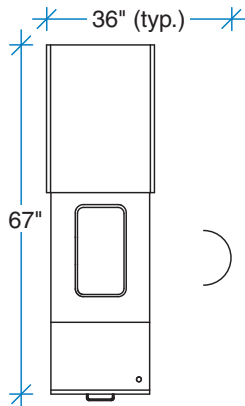

W	H	D
21	29	29
	29	

- Flatbed Machine
- Pullout Sewing Platform
- Locking Door
- Needle-Left Orientation
- Side Seat Position
- Assist Lift
- Duplex Receptacle
- Table Extension

35008

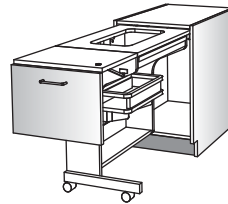

W	H	D
21	29	29
	29	

- Free-arm Machine
- Pullout Sewing Platform
- Locking Door
- Needle-Left Orientation
- Side Seat Position
- Assist Lift
- Duplex Receptacle
- Table Extension

35010

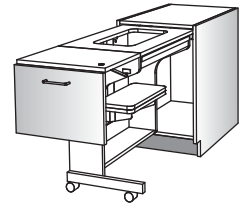

Ironing Center

Ironing Centers



Iron-A-Way Assembly is hinged to provide access to adjustable shelves located behind it.

Iron-A-Way ironing board stores securely in an upright position and pivots down to a horizontal use position.

Iron-A-Way Assembly

Includes:

- 42" Ventilated Metal Board
- Hot Iron Storage Compartment
- Storage Shelf
- Ironing Board Cover and Pad

W H D
21 84 24

Right Hinge Door
Iron-A-Way Assembly
Upper Fixed Shelf
Lower Adjustable Shelf
GFI
Must be securely attached to building structure

25623

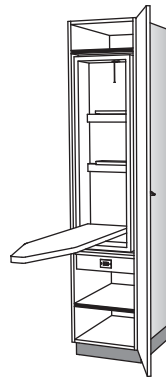

W H D
21 84 24

Left Hinge Door
Iron-A-Way Assembly
Upper Fixed Shelf
Lower Adjustable Shelf
GFI
Must be securely attached to building structure

25624



W H D
36 84 24

Doors
Iron-A-Way Assembly
Left: Upper Fixed Shelf,
Lower Adjustable Shelf, GFI
Right: Fixed Shelf, Hanger Bar
Must be securely attached to building structure

25622



Slideout Ironing Board

W H D
18 35 24

Right Hinge Door
Slideout Ironing Board
Adjustable Shelf
Total Extension from Wall = 60³/₈"

10625

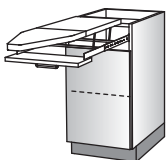

W H D
18 35 24

Left Hinge Door
Slideout Ironing Board
Adjustable Shelf
Total Extension from Wall = 60³/₈"

10626

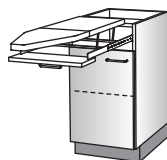

Ironing Board Storage

W H D
24 84 24

Right Hinge Door
4 Adjustable Shelves
Center Divider
Full Height Compartment

25627



W H D
24 84 24

Left Hinge Door
4 Adjustable Shelves
Center Divider
Full Height Compartment

25628



W H D
48 84 24

Doors
4 Adjustable Shelves
2 Vertical Dividers
2 Full Height Compartments

25629

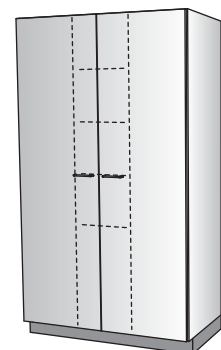

Fitting Platform

W H D
20 07 20

10627

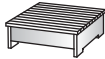

Wall Mounted
3-Way Mirror

W H D
57 60 02

3-Way Mirror

15700

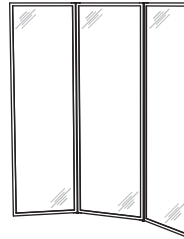

Movable 3-Way
Mirror

W H D
57 75 22

3-Way Mirror
Dual-Wheel Casters

60700

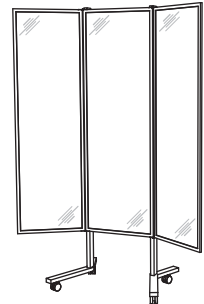

W H D
24 84 24

Right Hinge Door
Upper and Lower
Storage Compartments

25650

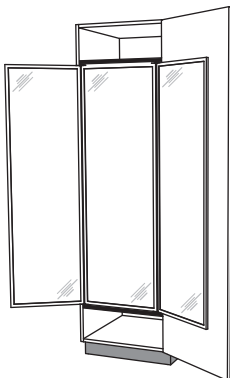

W H D
24 84 24

Left Hinge Door
Upper and Lower
Storage Compartments

25651

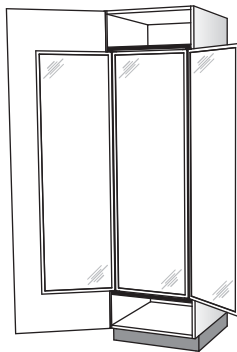

3-Way Mirror

W H D
48 84 24

Doors
Upper and Lower
Storage Compartments
4 Fixed Shelves

25652

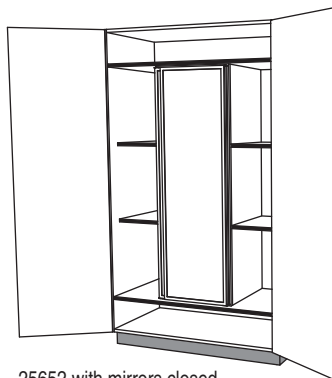

25652 with mirrors closed

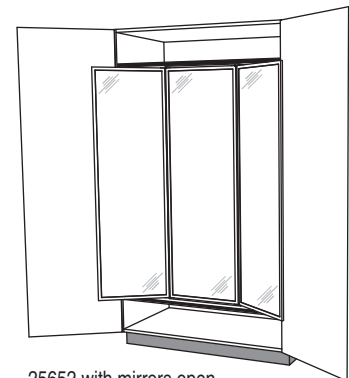

25652 with mirrors open

HOME ARTS – SEWING

Armoire



W H D
15 84 24
18
21
24

Right Hinge Door
Fixed Shelf
Hanger Bar
Drawer

25573



W H D
15 84 24
18
21
24

Left Hinge Door
Fixed Shelf
Hanger Bar
Drawer

25574



W H D
30 84 24
36
39
42
45
48

Doors
Fixed Shelf
Hanger Bar
Drawer

25576

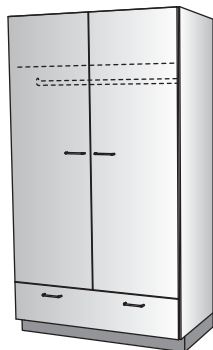

30W/36W drawers have single pull

W H D
30 84 24
36
39
42
45
48

Doors
Center Vertical Divider
2 Fixed Shelves
2 Hanger Bars
2 Drawers

25578

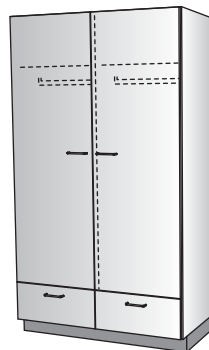

W H D
30 84 24
36
39
42
45
48

Doors
Fixed Shelf
Hanger Bar
2 Drawers

25579

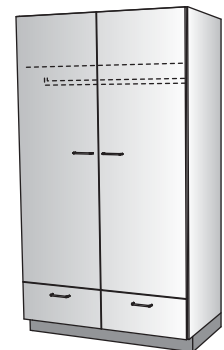

W H D
15 84 24
18
21
24

Right Hinge Door
Hanger Bar
2 Drawers

W H D
15 84 24
18
21
24

Left Hinge Door
Hanger Bar
2 Drawers

25580

25581



W H D
30 84 24
36
39
42
45
48

Doors
Hanger Bar
2 Drawers

W H D
30 84 24
36
39
42
45
48

Doors
Center Vertical Divider
2 Hanger Bars
4 Drawers

W H D
30 84 24
36
39
42
45
48

Doors
Hanger Bar
4 Drawers

25577

25582

25583



30W/36W drawers have single pull

Crafts/Cutting Table

See Countertop section for available top series.

SUGGESTED TOP SERIES	
Series	Description
LS05_27	1 1/16" High Pressure Laminate with 3mm Edge
PS59_29	1 1/8" Solid Surface with 3R/3R Profile Edge
WD00S44	1 3/4" Hardwood (Maple)

Round Crafts/Cutting Table

W	H	D
42	30	42
	34	
48	30	48
	34	

Powder Coated 2x2
Steel Tubular Legs
Adjustable Leveling Glides
Laminate Plycore Frame Rails
34H = ADA Height

38890



Square Crafts/Cutting Table

W	H	D
42	30	42
	34	
48	30	48
	34	

Powder Coated 2x2
Steel Tubular Legs
Adjustable Leveling Glides
Laminate Plycore Frame Rails
34H = ADA Height

38892

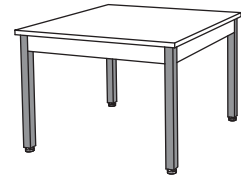

Rectangle Crafts/Cutting Table

W	H	D
36	60	30
42	66	34
48	72	
54		

Powder Coated 2x2
Steel Tubular Legs
Adjustable Leveling Glides
Laminate Plycore Frame Rails
34H = ADA Height

38860

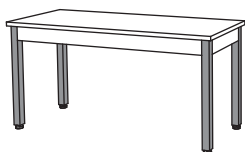

W	H	D
36	60	30
42	66	34
48	72	
54		

Powder Coated 2x2
Steel Tubular Legs
Adjustable Leveling Glides
Laminate Plycore Frame Rails
34H = ADA Height

38868

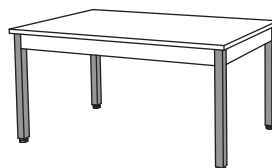

W	H	D
48	66	30
54	72	34
60		48

Powder Coated 2x2
Steel Tubular Legs
Adjustable Leveling Glides
Laminate Plycore Frame Rails
34H = ADA Height

38876

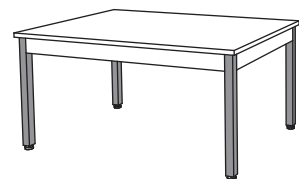



Steel Frame Crafts/Cutting Table

See Countertop section for available top series.

SUGGESTED TOP SERIES	
Series	Description
LS05_27	1 1/16" High Pressure Laminate with 3mm Edge
PS59_29	1 1/8" Solid Surface with 3R/3R Profile Edge
WD00S44	1 3/4" Hardwood (Maple)

For Steel Frame Crafts/Cutting Table and Extension Table combinations, tops provided in one-piece lengths up to maximum of:

- 143 1/2" High Pressure Laminate
- 119 1/2" Solid Surface
- 143 1/2" Hardwood (Maple)

Steel Frame Crafts/Cutting Table

W	H	D
36	30	30
42	34	36
48		
54		
60		
66		
72		

Powder Coated, Heavy Welded Steel Frame Assembly
Bolted 2x2 Tubular Legs
Adjustable Leveling Glides
34H = ADA Height

W	H	D
48	30	42
54	34	48
60		
66		
72		

Powder Coated, Heavy Welded Steel Frame Assembly
Bolted 2x2 Tubular Legs
Adjustable Leveling Glides
34H = ADA Height

38768



38776



Steel Frame Crafts/Cutting Extension Table

W	H	D
35	30	30
41	34	36
47		
53		
59		
65		
71		

Powder Coated, Heavy Welded Steel Frame Assembly
Bolted 2x2 Tubular Legs
Adjustable Leveling Glides
34H = ADA Height

W	H	D
47	30	42
53	34	48
59		
65		
71		

Powder Coated, Heavy Welded Steel Frame Assembly
Bolted 2x2 Tubular Legs
Adjustable Leveling Glides
34H = ADA Height

38772

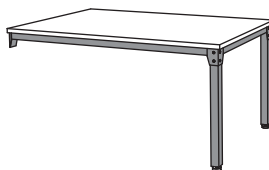

38780

