

Table of Contents

Terms and Codes 5

COUNTERTOPS

Laminate Series 6-10

LS00: 90° postform edge top, applied 90° postform edge
backsplash, applied self edge endsplash 6

LS05: 3mm edge top, applied 3mm edge backsplash and
endsplash 6

LS07: Self edge top, applied self edge backsplash and
endsplash 7

LS10: 90° postform edge top, integral coved 90° postform edge
backsplash, applied self edge endsplash 7

LS11: 3mm edge top, integral coved 3mm edge backsplash,
applied 3mm edge endsplash 8

LS15: 180° postform edge top, applied 90° postform edge
backsplash, applied self edge endsplash 8

LS16: 180° postform edge top, integral coved 90° postform
edge backsplash, applied self edge endsplash 9

LS25: Chemsurf face laminate, 3mm edge top, applied 3mm
edge backsplash and endsplash 10

LS26: Chemsurf face laminate, self edge top, applied self edge
backsplash and endsplash 10

Wood Edge Laminate Series: Profile wood edge top,
applied 90° postform edge
backsplash, applied self edge
endsplash 11-14

LS60: 3R/3R profile top 11

LS64: 6R/6R profile top 11

LS65: 12B/0 profile top 12

LS67: 12R/0 profile top 12

LS68: 12R/12R profile top 13

LS70: Bullnose profile top 13

LS71: 6R/0 profile top 14

Solid Surface Series: Profile edge top, applied .5B/0 profile
edge backsplash and endsplash 15-20

PS59: 3R/3R profile top 15

PS60: 3R/.5B profile top 15

PS61: 6B/.5B profile top 16

PS62: 6B/6B profile top 16

PS63: 6R/.5B profile top 17

PS64: 6R/6R profile top 17

PS65: 12B/.5B profile top 18

PS66: 12R/.5B profile top 18

PS67: 12R/6R profile top 19

PS68: 12R/12R profile top 19

PS72: .5B/.5B profile top 20

(continued on page 2)



Table of Contents *(continued)*

Solid Surface Series: Profile edge top, integral covered .5B/0 profile edge backsplash, applied .5B/0 profile edge endsplash	21-26
PS79: 3R/3R profile top	21
PS80: 3R/.5B profile top	21
PS81: 6B/.5B profile top	22
PS82: 6B/6B profile top	22
PS83: 6R/.5B profile top	23
PS84: 6R/6R profile top	23
PS85: 12B/.5B profile top	24
PS86: 12R/.5B profile top	24
PS87: 12R/6R profile top	25
PS88: 12R/12R profile top	25
PS92: .5B/.5B profile top	26
 Epoxy Resin Series: 3mm bevel/radius edges	27
ES00: Applied backsplash and endsplash	27
ES02: Lipped marine edge top, applied backsplash and endsplash	27
 Hardwood Series	28
WD00	28
 Stainless Steel Series	29-30
SS00: Formed edge	29
SS01: Marine edge	30
 Phenolic Series	31-33
AP00: Decorative face	31
AP01: Black acid resistant face	31
AP02: Decorative acid resistant face	32
AP03: Decorative face, drip groove	32
AP04: Black acid resistant face, drip groove	33
AP05: Decorative acid resistant face, drip groove	33
 Granite Series: Applied straight polish profile edge backsplash and endsplash	34-35
GS00: Straight polish/straight polish profile edge top	34
GS01: Bevel ±1/4"/straight polish profile edge top	34
GS02: Half bullnose/straight polish profile edge top	35
 Marble Series: Applied straight polish profile edge backsplash and endsplash	36-37
MS00: Straight polish/straight polish profile edge top	36
MS01: Bevel ±1/4"/straight polish profile edge top	36
MS02: Half bullnose/straight polish profile edge top	37

(continued on page 3)

Table of Contents *(continued)*

Quartz Series: Applied straight polish profile edge backsplash and endsplash **38-39**

 QS00: Straight polish/straight polish profile edge top 38

 QS01: Bevel ±1/4"/straight polish profile edge top..... 38

 QS02: Half bullnose/straight polish profile edge top 39

WINDOWSILLS

Laminate Series..... **40-42**

 LS50: Self edge 40

 LS51: 90° postform edge 41

 LS52: 180° postform edge 42

Solid Surface Series..... **43-44**

 PS10: 3R/3R profile edge 43

 PS11: 3R/.5B profile edge 43

 PS12: 6R/6R profile edge 44

 PS13: .5B/.5B profile edge..... 44

COUNTERTOPS

Commercial Cabinetry and Millwork





Stevens Industries, Inc., from its initial founding in 1956, has provided a complete solution of cabinets and countertops fabricated and coordinated as a full product offering. Stevens Advantage countertops, included with the wide range of cabinets and millwork, can complete the entire project's requirements. Countertops are available in several versions of laminate, solid surface (polymer), epoxy resin, hardwood, stainless steel, phenolic, granite, marble and quartz. The following technical descriptions and design data illustrate the available designs. Beyond those shown, Stevens Millwork can also provide unique special applications.

GLOSSARY OF TERMS:

3mm Edge:	Edge with high impact 3mm (1/8") thickness extrusion (patterns available from Stevens standard offering)
90° Postform:	Seamless formed High Pressure Laminate wrapped over a 90° radius profile (eliminates brown edges and separate applied edge strips)
180° Postform:	Seamless formed High Pressure Laminate wrapped over a 180° profile (eliminates brown edges and separate applied edge strips)
Backer:	Back underside faced with laminate backer
Chemsurf:	Chemical resistant laminate
HGS:	Horizontal Grade Standard
HPL:	Face surfacing in High Pressure Laminate
Integral Cove:	Backsplash with a concave formed seamless intersection between countertop and backsplash
Marine Edge:	Raised outside countertop edge
MDF:	Medium Density Fiberboard
NAF:	No Added Formaldehyde
Self Edge:	Edges laminated with same High Pressure Laminate as countertop face
TFL:	Thermally Fused Laminate
TSCA:	Toxic Substances Control Act

COUNTERTOP PREFIX CODES:

AP:	Phenolic	MS:	Marble
BW:	Laminated Workbench	PS:	Solid Surface (Polymer)
ES:	Epoxy Resin	QS:	Quartz
GS:	Granite	SS:	Stainless Steel
LS:	Laminate	WD:	Laminated Hardwood (Butcher Block)

COUNTERTOP CORE/SUBSTRATE CODES:

C:	TSCA particleboard	M:	Moisture-resistant/NAF particleboard
D:	Medium Density Fiberboard (MDF)	P:	Plywood
F:	Fire-rated particleboard	R:	Rail
G:	Moisture-resistant/NAF MDF	S:	Solid
H:	Fire-rated MDF		

COUNTERTOPS

Laminate Series

LT = Laminate Top
LB = Laminate Backsplash
LE = Laminate Endsplash



LS00

Example:
LS00C2721

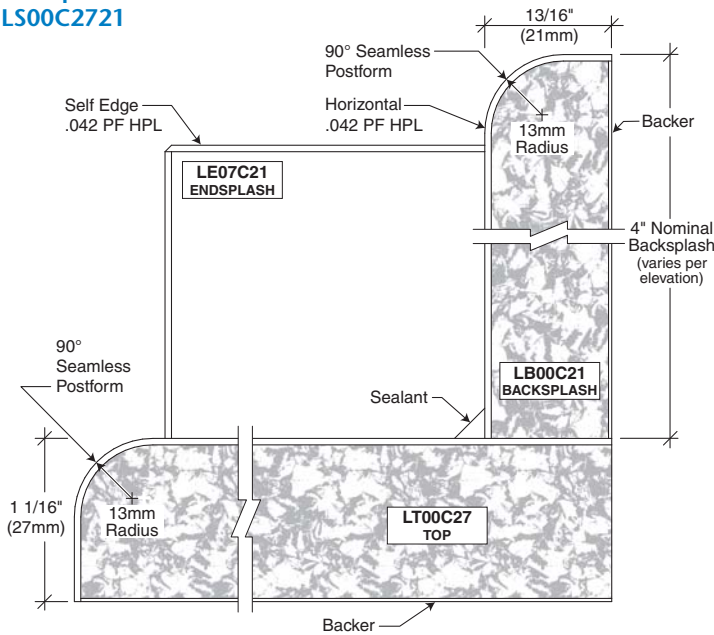

LS00 LAMINATE

- 90° postform edge top
- Applied 90° postform edge backsplash
- Applied self edge endsplash

Series/Core Codes:

- LS00C** TSCA particleboard
- LS00M** Moisture-resistant/NAF particleboard
- LS00F** Fire-rated particleboard
- LS00D** Medium Density Fiberboard (MDF)
- LS00G** Moisture-resistant/NAF MDF
- LS00H** Fire-rated MDF

LS00C, LS00M, LS00F, LS00D, LS00G and LS00H available countertop thicknesses:

- 21mm (13/16")
- 27mm (1-1/16")
- 30mm (1-3/16") (n/a for LS00F fire-rated particleboard)
- 40mm (1-9/16") (n/a for LS00H fire-rated MDF)

LS05

Example:
LS05C2721

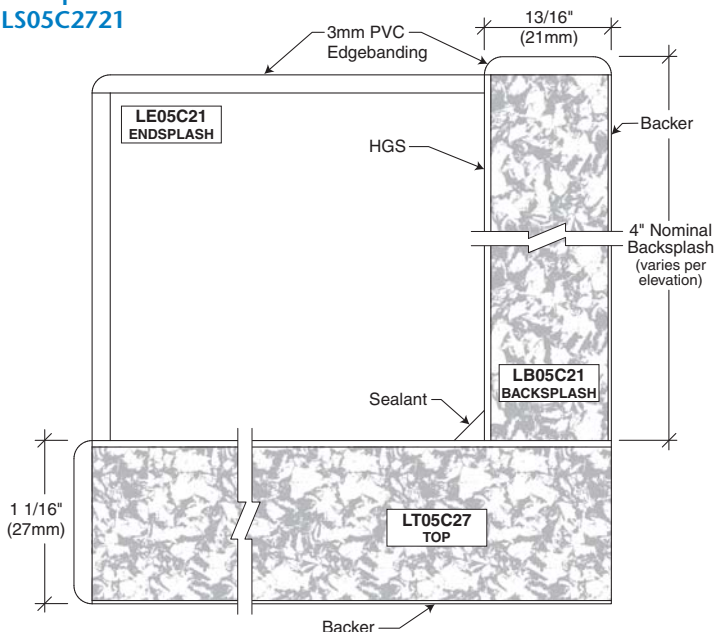

LS05 LAMINATE

- 3mm edge top
- Applied 3mm edge backsplash and endsplash

Series/Core Codes:

- LS05C** TSCA particleboard
- LS05M** Moisture-resistant/NAF particleboard
- LS05F** Fire-rated particleboard
- LS05D** Medium Density Fiberboard (MDF)
- LS05G** Moisture-resistant/NAF MDF
- LS05H** Fire-rated MDF
- LS05P** Plywood

LS05C, LS05M, LS05F, LS05D, LS05G and LS05H available countertop thicknesses:

- 21mm (13/16")
- 27mm (1-1/16")
- 30mm (1-3/16") (n/a for LS05F fire-rated particleboard)
- 40mm (1-9/16")* (n/a for LS05H fire-rated MDF)

LS05P available countertop thicknesses:

- 20mm (3/4")
- 27mm (1-1/16")
- 40mm (1-9/16")*

*edges: specific patterns only

LT = Laminate Top
LB = Laminate Backsplash
LE = Laminate Endsplash

LS07

Example:
LS07C2721

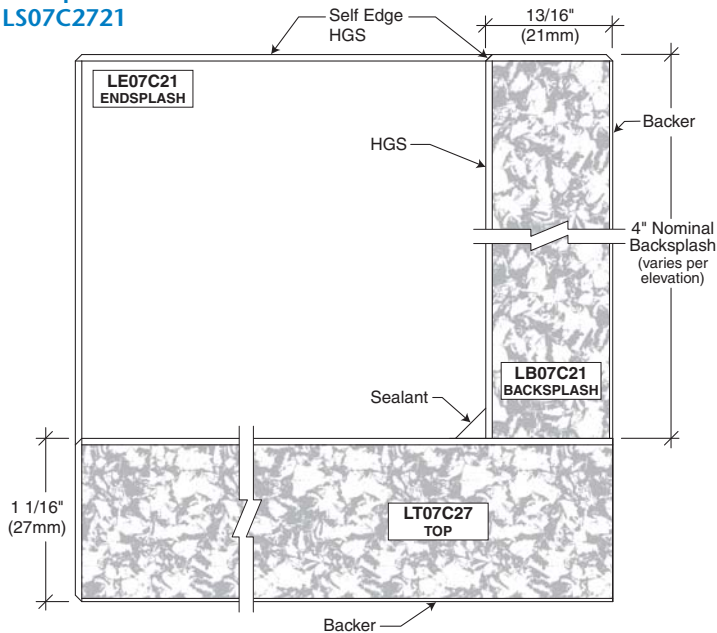

LS07 LAMINATE

- Self edge top
- Applied self edge backsplash and endsplash

Series/Core Codes:

- LS07C** TSCA particleboard
- LS07M** Moisture-resistant/NAF particleboard
- LS07F** Fire-rated particleboard
- LS07D** Medium Density Fiberboard (MDF)
- LS07G** Moisture-resistant/NAF MDF
- LS07H** Fire-rated MDF
- LS07P** Plywood

LS07C, LS07M, LS07F, LS07D, LS07G and LS07H available countertop thicknesses:

- 21mm (13/16")
- 27mm (1-1/16")
- 30mm (1-3/16") (n/a for LS07F fire-rated particleboard)
- 40mm (1-9/16") (n/a for LS07H fire-rated MDF)

LS07P available countertop thicknesses:

- 20mm (3/4")
- 27mm (1-1/16")
- 40mm (1-9/16")

Drop edge available upon special request in 1/2" increments, from 2" to 6". Drop edge not available over casework.

LS10

Example:
LS10C2721

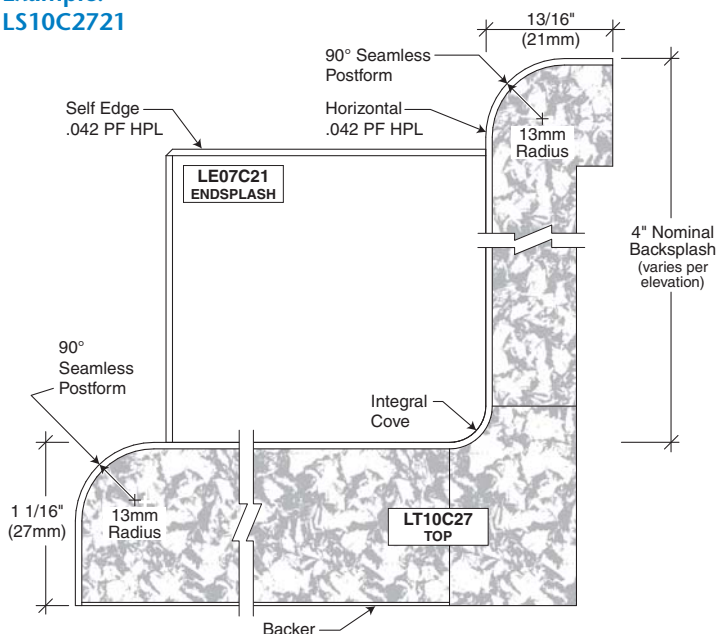

LS10 LAMINATE

- 90° postform edge top
- Integral coved 90° postform edge backsplash
- Applied self edge endsplash

Series/Core Codes:

- LS10C** TSCA particleboard
- LS10M** Moisture-resistant/NAF particleboard
- LS10F** Fire-rated particleboard
- LS10D** Medium Density Fiberboard (MDF)
- LS10G** Moisture-resistant/NAF MDF
- LS10H** Fire-rated MDF

LS10C, LS10M, LS10F, LS10D, LS10G and LS10H available countertop thicknesses:

- 21mm (13/16")
- 27mm (1-1/16")
- 30mm (1-3/16") (n/a for LS10F fire-rated particleboard)
- 40mm (1-9/16") (n/a for LS10H fire-rated MDF)

COUNTERTOPS

Laminate Series

LT = Laminate Top
LB = Laminate Backsplash
LE = Laminate Endsplash



LS11

Example:
LS11C2721

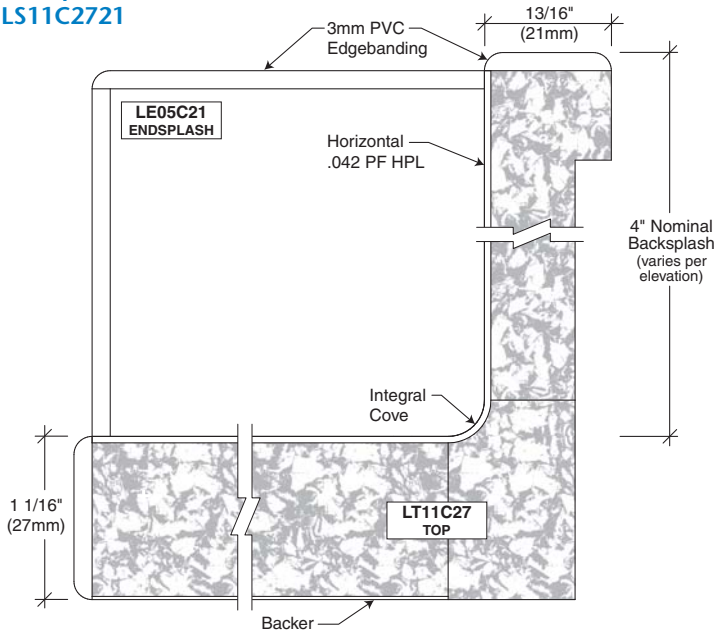

LS11 LAMINATE

- 3mm edge top
- Integral coved 3mm edge backsplash
- Applied 3mm edge endsplash

Series/Core Codes:

- LS11C** TSCA particleboard
LS11M Moisture-resistant/NAF particleboard
LS11F Fire-rated particleboard
LS11D Medium Density Fiberboard (MDF)
LS11G Moisture-resistant/NAF MDF
LS11H Fire-rated MDF
LS11P Plywood

LS11C, LS11M, LS11F, LS11D, LS11G and LS11H available countertop thicknesses:

- 21mm (13/16")
- 27mm (1-1/16")
- 30mm (1-3/16") (n/a for LS11F fire-rated particleboard)
- 40mm (1-9/16")* (n/a for LS11H fire-rated MDF)

LS11P available countertop thicknesses:

- 20mm (3/4")
- 27mm (1-1/16")
- 40mm (1-9/16")*

*edges: specific patterns only

LS15

Example:
LS15C2721

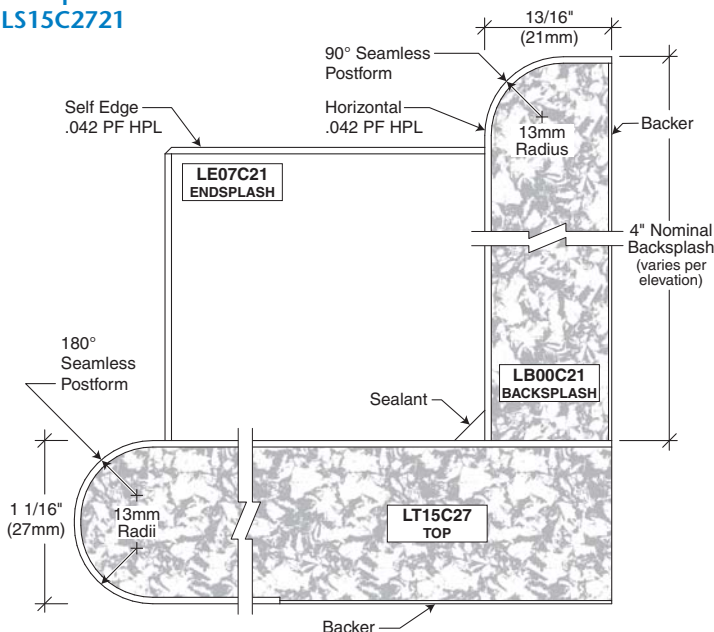

LS15 LAMINATE

- 180° postform edge top
- Applied 90° postform edge backsplash
- Applied self edge endsplash

Series/Core Codes:

- LS15C** TSCA particleboard
LS15M Moisture-resistant/NAF particleboard
LS15F Fire-rated particleboard
LS15D Medium Density Fiberboard (MDF)
LS15G Moisture-resistant/NAF MDF
LS15H Fire-rated MDF

LS15C, LS15M, LS15F, LS15D, LS15G and LS15H available countertop thicknesses:

- 27mm (1-1/16")
- 30mm (1-3/16") (n/a for LS15F fire-rated particleboard)
- 40mm (1-9/16") (n/a for LS15H fire-rated MDF)

LT = Laminate Top
LB = Laminate Backsplash
LE = Laminate Endsplash

LS16

Example:
LS16C2721

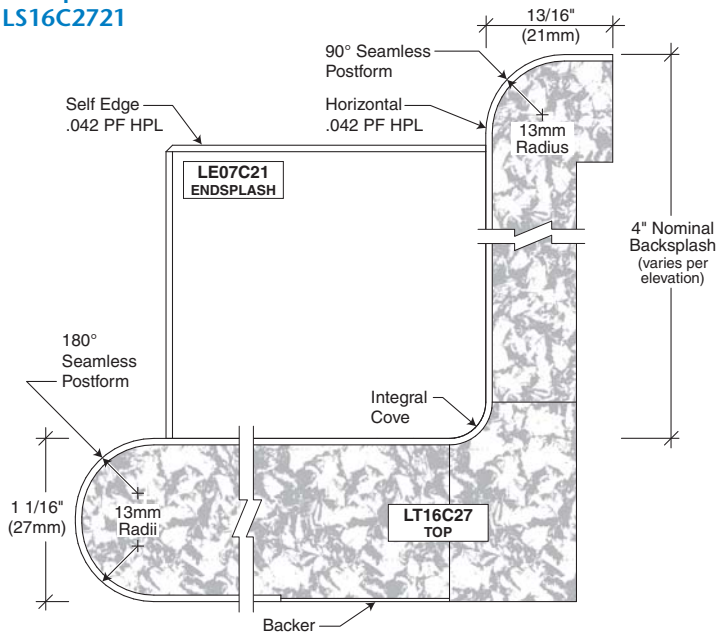

LS16 LAMINATE

- 180° postform edge top
- Integral cove 90° postform edge backsplash
- Applied self edge endsplash

Series/Core Codes:

- LS16C** TSCA particleboard
- LS16M** Moisture-resistant/NAF particleboard
- LS16F** Fire-rated particleboard
- LS16D** Medium Density Fiberboard (MDF)
- LS16G** Moisture-resistant/NAF MDF
- LS16H** Fire-rated MDF

LS16C, LS16M, LS16F, LS16D, LS16G and LS16H available countertop thicknesses:

- 27mm (1-1/16")
- 30mm (1-3/16") (n/a for LS16F fire-rated particleboard)
- 40mm (1-9/16") (n/a for LS16H fire-rated MDF)

COUNTERTOPS

Laminate Series Chemsurf

LT = Laminate Top
LB = Laminate Backsplash
LE = Laminate Endsplash



LS25

Example:
LS25C2721

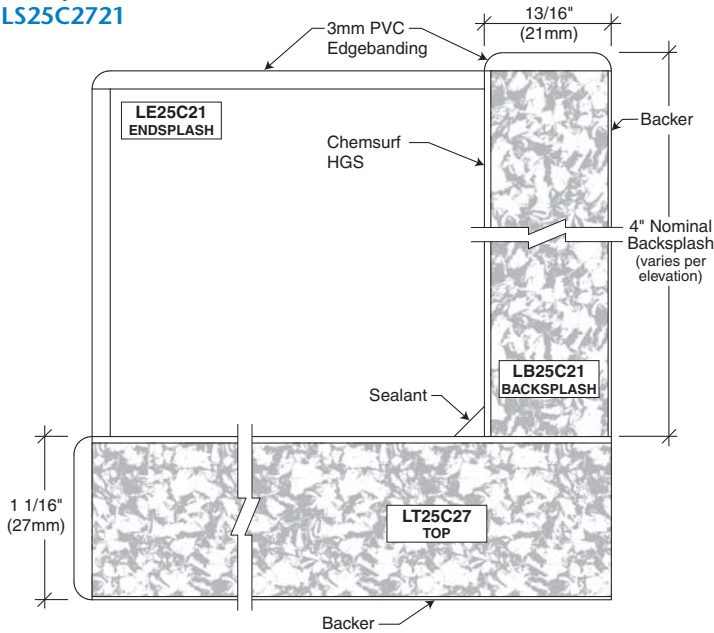

LS25 LAMINATE

- Chemsurf face laminate
- 3mm edge top
- Applied 3mm edge backsplash and endsplash

Series/Core Codes:

- LS25C** TSCA particleboard
- LS25M** Moisture-resistant/NAF particleboard
- LS25F** Fire-rated particleboard
- LS25D** Medium Density Fiberboard (MDF)
- LS25G** Moisture-resistant/NAF MDF
- LS25H** Fire-rated MDF
- LS25P** Plywood

LS25C, LS25M, LS25F, LS25D, LS25G and LS25H available countertop thicknesses:

- 21mm (13/16")
- 27mm (1-1/16")
- 30mm (1-3/16") (n/a for LS25F fire-rated particleboard)
- 40mm (1-9/16")* (n/a for LS25H fire-rated MDF)

LS25P available countertop thicknesses:

- 20mm (3/4")
- 27mm (1-1/16")
- 40mm (1-9/16")*

*edges: specific patterns only

LS26

Example:
LS26C2721

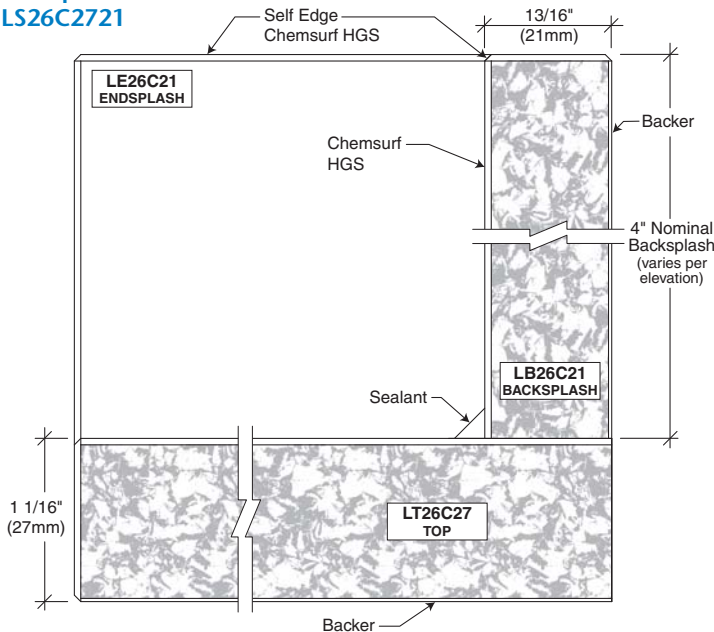

LS26 LAMINATE

- Chemsurf face laminate
- Self edge top
- Applied self edge backsplash and endsplash

Series/Core Codes:

- LS26C** TSCA particleboard
- LS26M** Moisture-resistant/NAF particleboard
- LS26F** Fire-rated particleboard
- LS26D** Medium Density Fiberboard (MDF)
- LS26G** Moisture-resistant/NAF MDF
- LS26H** Fire-rated MDF
- LS26P** Plywood

LS26C, LS26M, LS26F, LS26D, LS26G and LS26H available countertop thicknesses:

- 21mm (13/16")
- 27mm (1-1/16")
- 30mm (1-3/16") (n/a for LS26F fire-rated particleboard)
- 40mm (1-9/16") (n/a for LS26H fire-rated MDF)

LS26P available countertop thicknesses:

- 20mm (3/4")
- 27mm (1-1/16")
- 40mm (1-9/16")

Drop edge available upon special request in 1/2" increments, from 2" to 6". Drop edge not available over casework.

LT = Laminate Top
LB = Laminate Backsplash
LE = Laminate Endsplash

LS60

(Stevens preferred)

Example:
LS60C2721

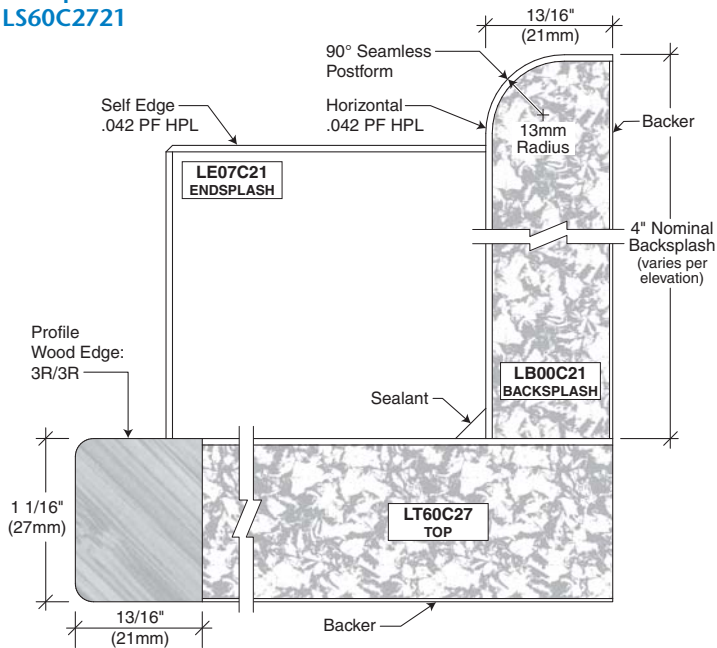

LS60 LAMINATE WITH WOOD EDGE

- 3R/3R profile wood edge top
- Applied 90° postform edge backsplash
- Applied self edge endsplash

Series/Core Codes:

- LS60C TSCA particleboard
- LS60M Moisture-resistant/NAF particleboard
- LS60F Fire-rated particleboard
- LS60D Medium Density Fiberboard (MDF)
- LS60G Moisture-resistant/NAF MDF
- LS60H Fire-rated MDF

LS60C, LS60M, LS60F, LS60D, LS60G and LS60H available countertop thicknesses:

- 21mm (13/16")
- 27mm (1-1/16")
- 30mm (1-3/16") (n/a for LS60F fire-rated particleboard)
- 40mm (1-9/16") (n/a for LS60H fire-rated MDF)

Wood Edge available species and finishes:

- Species: maple, red oak, cherry
- Finishes: Stevens current standards

LS64

Example:
LS64C2721

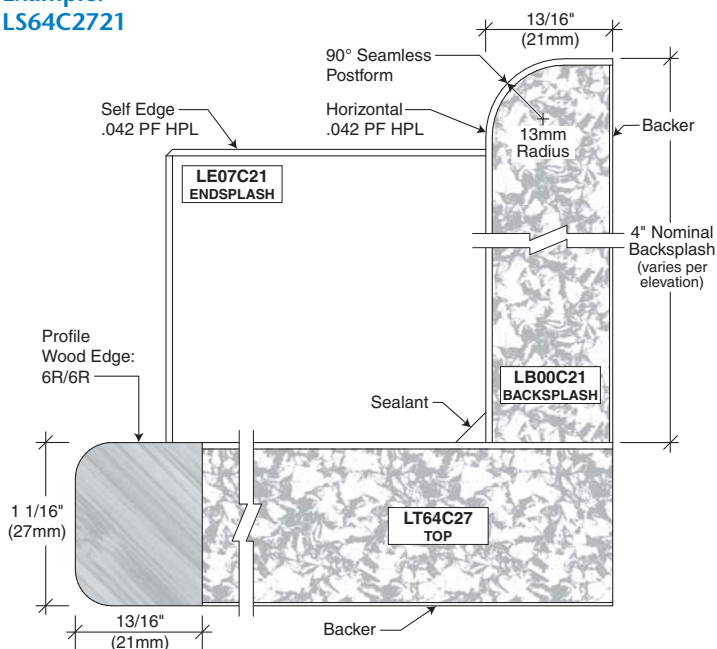

LS64 LAMINATE WITH WOOD EDGE

- 6R/6R profile wood edge top
- Applied 90° postform edge backsplash
- Applied self edge endsplash

Series/Core Codes:

- LS64C TSCA particleboard
- LS64M Moisture-resistant/NAF particleboard
- LS64F Fire-rated particleboard
- LS64D Medium Density Fiberboard (MDF)
- LS64G Moisture-resistant/NAF MDF
- LS64H Fire-rated MDF

LS64C, LS64M, LS64F, LS64D, LS64G and LS64H available countertop thicknesses:

- 21mm (13/16")
- 27mm (1-1/16")
- 30mm (1-3/16") (n/a for LS64F fire-rated particleboard)
- 40mm (1-9/16") (n/a for LS64H fire-rated MDF)

Wood Edge available species and finishes:

- Species: maple, red oak, cherry
- Finishes: Stevens current standards

COUNTERTOPS

Laminate Series Wood Edge Top

LT = Laminate Top
LB = Laminate Backsplash
LE = Laminate Endsplash



LS65

Example:
LS65C2721

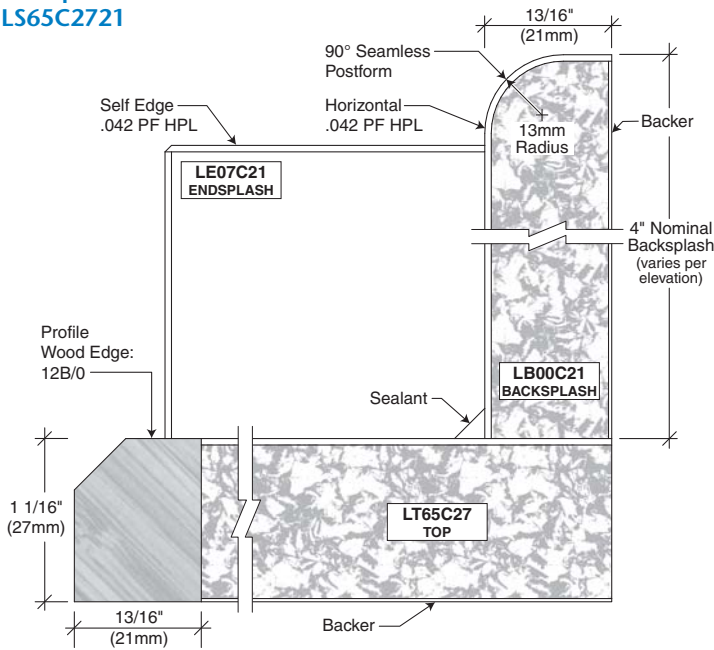

LS65 LAMINATE WITH WOOD EDGE

- 12B/0 profile wood edge top
- Applied 90° postform edge backsplash
- Applied self edge endsplash

Series/Core Codes:

- LS65C** TSCA particleboard
- LS65M** Moisture-resistant/NAF particleboard
- LS65F** Fire-rated particleboard
- LS65D** Medium Density Fiberboard (MDF)
- LS65G** Moisture-resistant/NAF MDF
- LS65H** Fire-rated MDF

LS65C, LS65M, LS65F, LS65D, LS65G and LS65H available countertop thicknesses:

- 21mm (13/16")
- 27mm (1-1/16")
- 30mm (1-3/16") (n/a for LS65F fire-rated particleboard)
- 40mm (1-9/16") (n/a for LS65H fire-rated MDF)

Wood Edge available species and finishes:

- Species: maple, red oak, cherry
- Finishes: Stevens current standards

LS67

Example:
LS67C2721

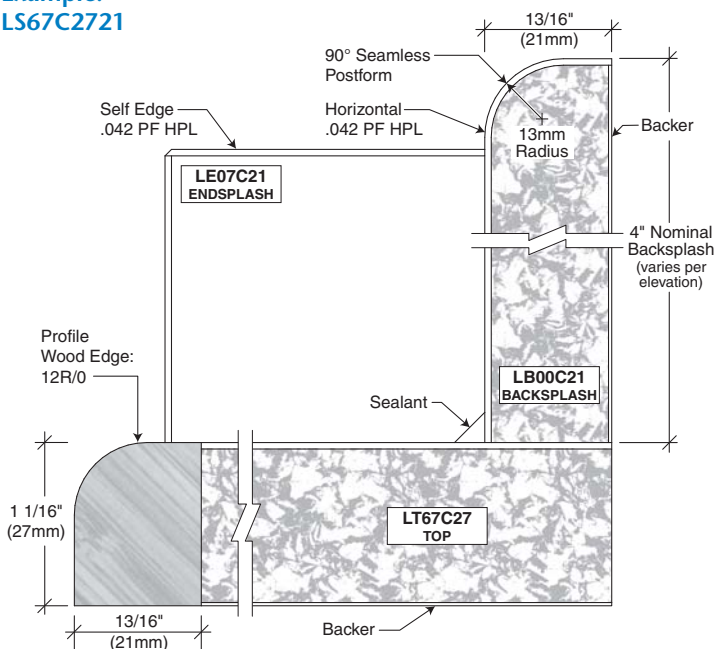

LS67 LAMINATE WITH WOOD EDGE

- 12R/0 profile wood edge top
- Applied 90° postform edge backsplash
- Applied self edge endsplash

Series/Core Codes:

- LS67C** TSCA particleboard
- LS67M** Moisture-resistant/NAF particleboard
- LS67F** Fire-rated particleboard
- LS67D** Medium Density Fiberboard (MDF)
- LS67G** Moisture-resistant/NAF MDF
- LS67H** Fire-rated MDF

LS67C, LS67M, LS67F, LS67D, LS67G and LS67H available countertop thicknesses:

- 21mm (13/16")
- 27mm (1-1/16")
- 30mm (1-3/16") (n/a for LS67F fire-rated particleboard)
- 40mm (1-9/16") (n/a for LS67H fire-rated MDF)

Wood Edge available species and finishes:

- Species: maple, red oak, cherry
- Finishes: Stevens current standards

LT = Laminate Top
LB = Laminate Backsplash
LE = Laminate Endsplash

LS68

Example:
LS68C2721

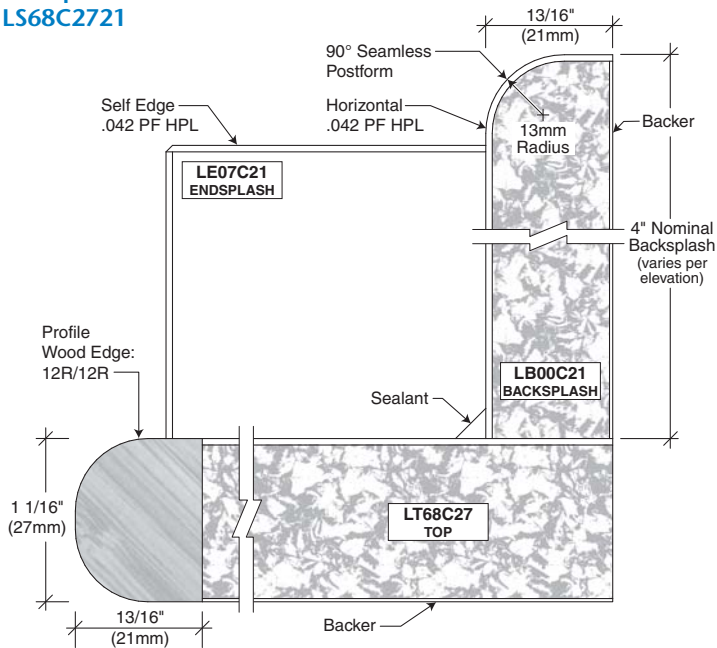

LS68 LAMINATE WITH WOOD EDGE

- 12R/12R profile wood edge top
- Applied 90° postform edge backsplash
- Applied self edge endsplash

Series/Core Codes:

- LS68C** TSCA particleboard
- LS68M** Moisture-resistant/NAF particleboard
- LS68F** Fire-rated particleboard
- LS68D** Medium Density Fiberboard (MDF)
- LS68G** Moisture-resistant/NAF MDF
- LS68H** Fire-rated MDF

LS68C, LS68M, LS68F, LS68D, LS68G and LS68H available countertop thicknesses:

- 27mm (1-1/16")
- 30mm (1-3/16") (n/a for LS68F fire-rated particleboard)
- 40mm (1-9/16") (n/a for LS68H fire-rated MDF)

Wood Edge available species and finishes:

- Species: maple, red oak, cherry
- Finishes: Stevens current standards

LS70

Example:
LS70C2721

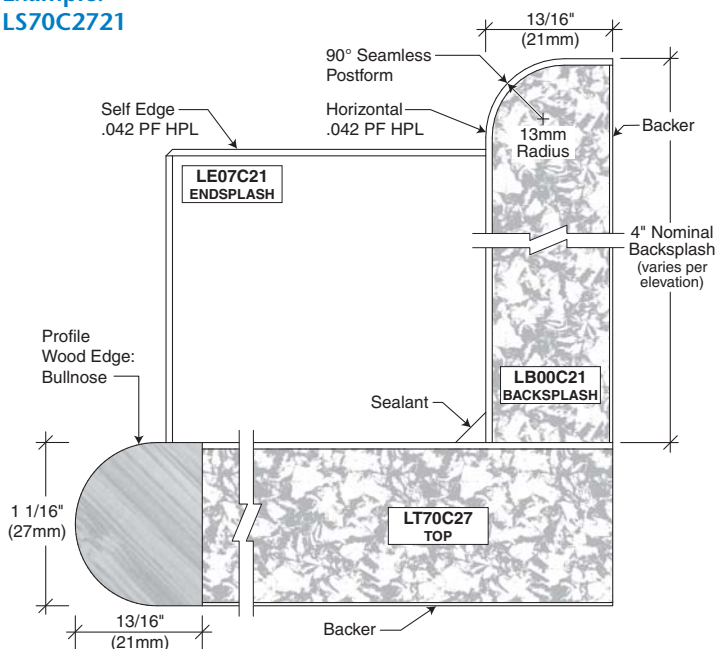

LS70 LAMINATE WITH WOOD EDGE

- Bullnose profile wood edge top
- Applied 90° postform edge backsplash
- Applied self edge endsplash

Series/Core Codes:

- LS70C** TSCA particleboard
- LS70M** Moisture-resistant/NAF particleboard
- LS70F** Fire-rated particleboard
- LS70D** Medium Density Fiberboard (MDF)
- LS70G** Moisture-resistant/NAF MDF
- LS70H** Fire-rated MDF

LS70C, LS70M, LS70F, LS70D, LS70G and LS70H available countertop thicknesses:

- 21mm (13/16")
- 27mm (1-1/16")
- 30mm (1-3/16") (n/a for LS70F fire-rated particleboard)

Wood Edge available species and finishes:

- Species: maple, red oak, cherry
- Finishes: Stevens current standards

COUNTERTOPS

Laminate Series Wood Edge Top

LT = Laminate Top
LB = Laminate Backsplash
LE = Laminate Endsplash



LS71

Example:
LS71C2721

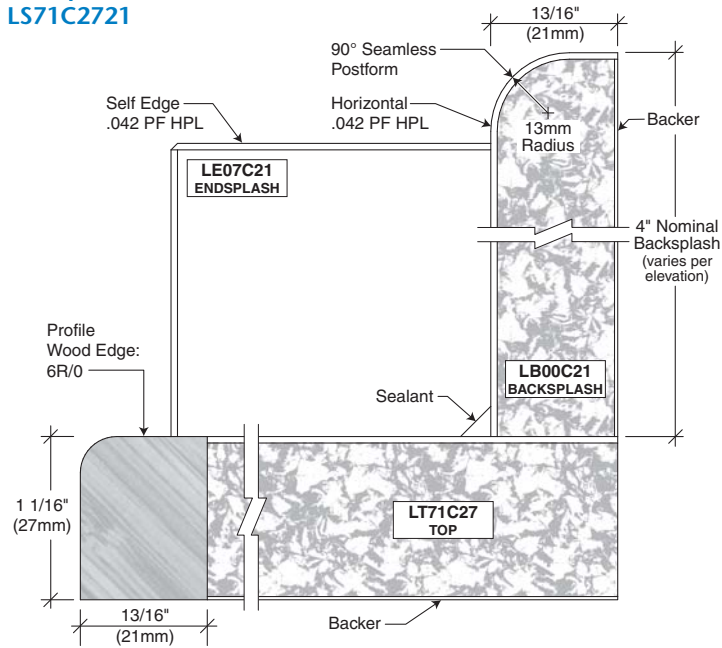

LS71 LAMINATE WITH WOOD EDGE

- 6R/0 profile wood edge top
- Applied 90° postform edge backsplash
- Applied self edge endsplash

Series/Core Codes:

- LS71C** TSCA particleboard
- LS71M** Moisture-resistant/NAF particleboard
- LS71F** Fire-rated particleboard
- LS71D** Medium Density Fiberboard (MDF)
- LS71G** Moisture-resistant/NAF MDF
- LS71H** Fire-rated MDF

LS71C, LS71M, LS71F, LS71D, LS71G and LS71H available countertop thicknesses:

- 21mm (13/16")
- 27mm (1-1/16")
- 30mm (1-3/16") (n/a for LS71F fire-rated particleboard)
- 40mm (1-9/16") (n/a for LS71H fire-rated MDF)

Wood Edge available species and finishes:

- Species: maple, red oak, cherry
- Finishes: Stevens current standards

PT = Solid Surface Top
PB = Solid Surface Backsplash
PE = Solid Surface Endsplash

PS59

(Stevens preferred)

Example:
PS59C2912

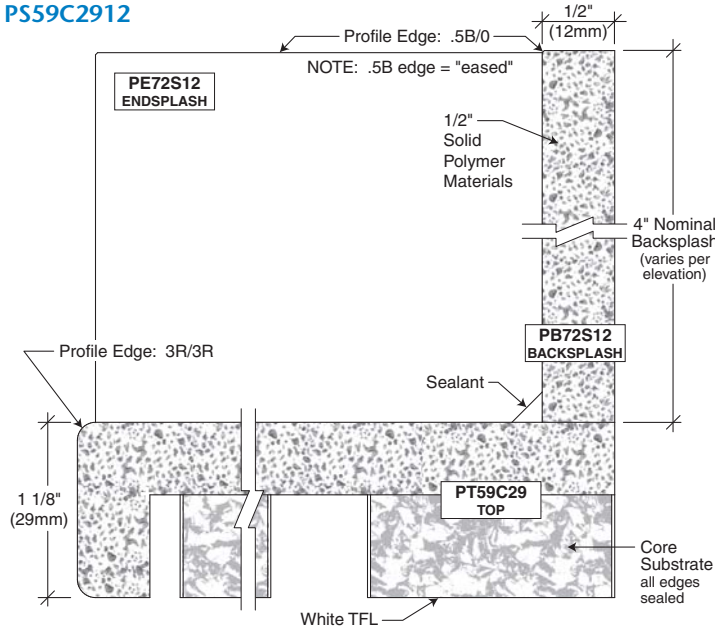

PS59 SOLID SURFACE

- Solid surface (polymer) materials
- 3R/3R profile edge top
- Applied .5B/0 profile edge backsplash and endsplash

Series/Core Substrate Codes:

- PS59C** TSCA particleboard
PS59M Moisture-resistant/NAF particleboard
PS59F Fire-rated particleboard
PS59D Medium Density Fiberboard (MDF)
PS59G Moisture-resistant/NAF MDF
PS59H Fire-rated MDF
PS59P Plywood

Backsplash and Endsplash Model/Core Codes:

- PB72S** Solid
PE72S Solid

PS59C, PS59M, PS59F, PS59D, PS59G, PS59H and **PS59P** available countertop thicknesses:
29mm (1-1/8")
38mm (1-1/2")

Drop edge available upon special request in 1/2" increments, from 2" to 6". Drop edge not available over casework.

PS60

Example:
PS60C2912

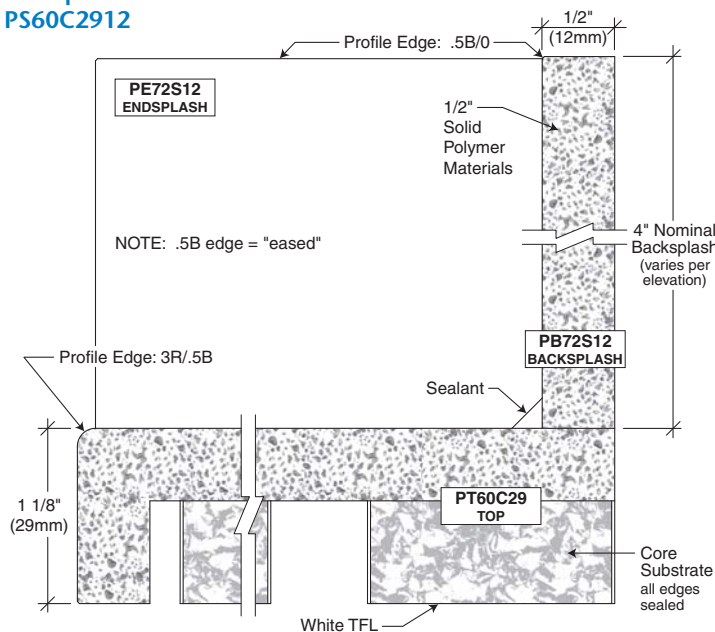

PS60 SOLID SURFACE

- Solid surface (polymer) materials
- 3R/.5B profile edge top
- Applied .5B/0 profile edge backsplash and endsplash

Series/Core Substrate Codes:

- PS60C** TSCA particleboard
PS60M Moisture-resistant/NAF particleboard
PS60F Fire-rated particleboard
PS60D Medium Density Fiberboard (MDF)
PS60G Moisture-resistant/NAF MDF
PS60H Fire-rated MDF
PS60P Plywood

Backsplash and Endsplash Model/Core Codes:

- PB72S** Solid
PE72S Solid

PS60C, PS60M, PS60F, PS60D, PS60G, PS60H and **PS60P** available countertop thicknesses:
29mm (1-1/8")
38mm (1-1/2")

Drop edge available upon special request in 1/2" increments, from 2" to 6". Drop edge not available over casework.

COUNTERTOPS

Solid Surface Series

PT = Solid Surface Top
 PB = Solid Surface Backsplash
 PE = Solid Surface Endsplash



PS61

Example:
 PS61C2912

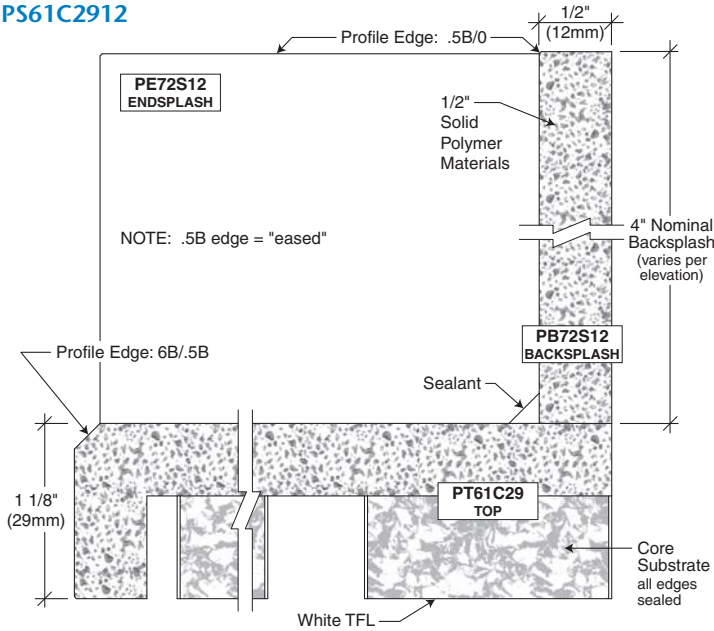

PS61 SOLID SURFACE

- Solid surface (polymer) materials
- 6B/.5B profile edge top
- Applied .5B/0 profile edge backsplash and endsplash

Series/Core Substrate Codes:

- PS61C TSCA particleboard
 PS61M Moisture-resistant/NAF particleboard
 PS61F Fire-rated particleboard
 PS61D Medium Density Fiberboard (MDF)
 PS61G Moisture-resistant/NAF MDF
 PS61H Fire-rated MDF
 PS61P Plywood

Backsplash and Endsplash Model/Core Codes:

- PB72S Solid
 PE72S Solid

PS61C, PS61M, PS61F, PS61D, PS61G, PS61H and PS61P available countertop thicknesses:
 29mm (1-1/8")
 38mm (1-1/2")

Drop edge available upon special request in 1/2" increments, from 2" to 6". Drop edge not available over casework.

PS62

Example:
 PS62C2912

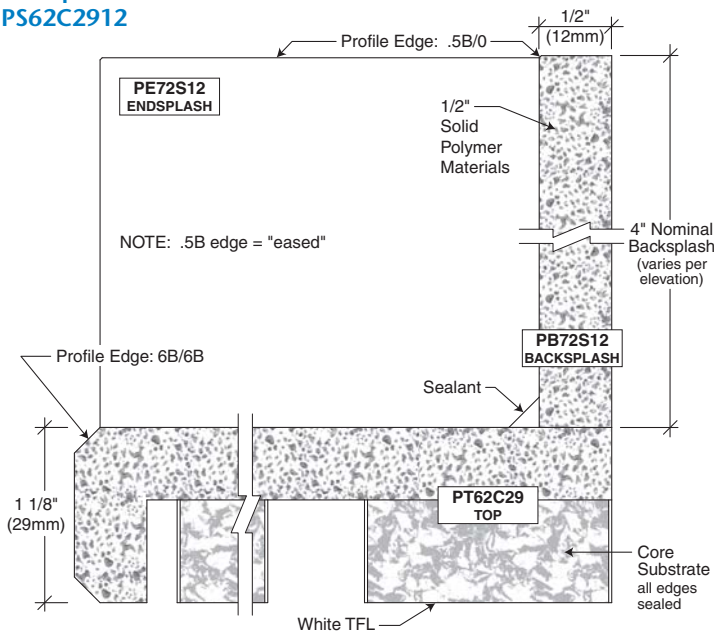

PS62 SOLID SURFACE

- Solid surface (polymer) materials
- 6B/6B profile edge top
- Applied .5B/0 profile edge backsplash and endsplash

Series/Core Substrate Codes:

- PS62C TSCA particleboard
 PS62M Moisture-resistant/NAF particleboard
 PS62F Fire-rated particleboard
 PS62D Medium Density Fiberboard (MDF)
 PS62G Moisture-resistant/NAF MDF
 PS62H Fire-rated MDF
 PS62P Plywood

Backsplash and Endsplash Model/Core Codes:

- PB72S Solid
 PE72S Solid

PS62C, PS62M, PS62F, PS62D, PS62G, PS62H and PS62P available countertop thicknesses:
 29mm (1-1/8")
 38mm (1-1/2")

Drop edge available upon special request in 1/2" increments, from 2" to 6". Drop edge not available over casework.

PT = Solid Surface Top
PB = Solid Surface Backsplash
PE = Solid Surface Endsplash

PS63

Example:
PS63C2912

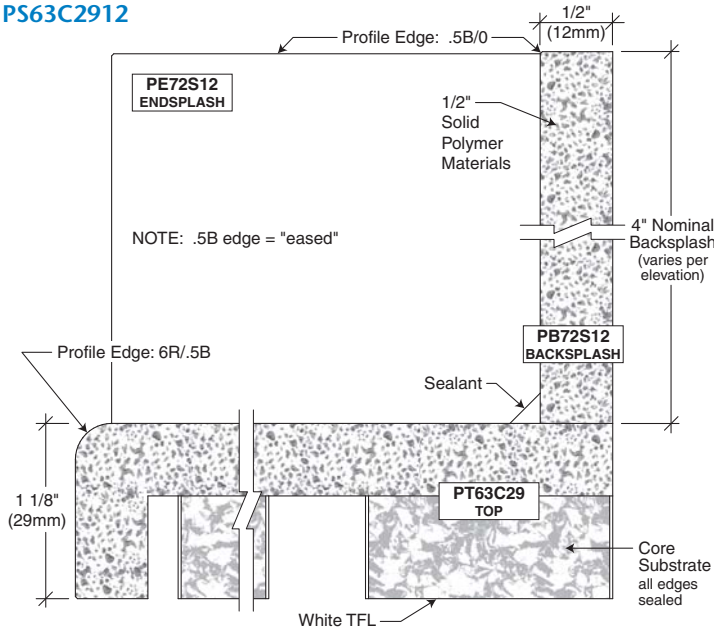

PS63 SOLID SURFACE

- Solid surface (polymer) materials
- 6R/.5B profile edge top
- Applied .5B/0 profile edge backsplash and endsplash

Series/Core Substrate Codes:

PS63C TSCA particleboard
PS63M Moisture-resistant/NAF particleboard
PS63F Fire-rated particleboard
PS63D Medium Density Fiberboard (MDF)
PS63G Moisture-resistant/NAF MDF
PS63H Fire-rated MDF
PS63P Plywood

Backsplash and Endsplash Model/Core Codes:

PB72S Solid
PE72S Solid

PS63C, PS63M, PS63F, PS63D, PS63G, PS63H and **PS63P** available countertop thicknesses:
29mm (1-1/8")
38mm (1-1/2")

Drop edge available upon special request in 1/2" increments, from 2" to 6". Drop edge not available over casework.

PS64

Example:
PS64C2912

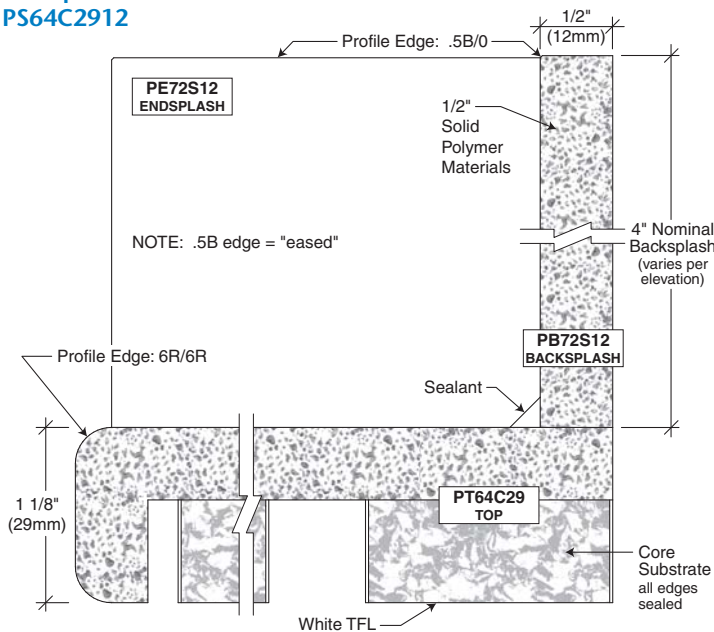

PS64 SOLID SURFACE

- Solid surface (polymer) materials
- 6R/6R profile edge top
- Applied .5B/0 profile edge backsplash and endsplash

Series/Core Substrate Codes:

PS64C TSCA particleboard
PS64M Moisture-resistant/NAF particleboard
PS64F Fire-rated particleboard
PS64D Medium Density Fiberboard (MDF)
PS64G Moisture-resistant/NAF MDF
PS64H Fire-rated MDF
PS64P Plywood

Backsplash and Endsplash Model/Core Codes:

PB72S Solid
PE72S Solid

PS64C, PS64M, PS64F, PS64D, PS64G, PS64H and **PS64P** available countertop thicknesses:
29mm (1-1/8")
38mm (1-1/2")

Drop edge available upon special request in 1/2" increments, from 2" to 6". Drop edge not available over casework.

COUNTERTOPS

Solid Surface Series

PT = Solid Surface Top
 PB = Solid Surface Backsplash
 PE = Solid Surface Endsplash



PS65

Example:
 PS65C2912

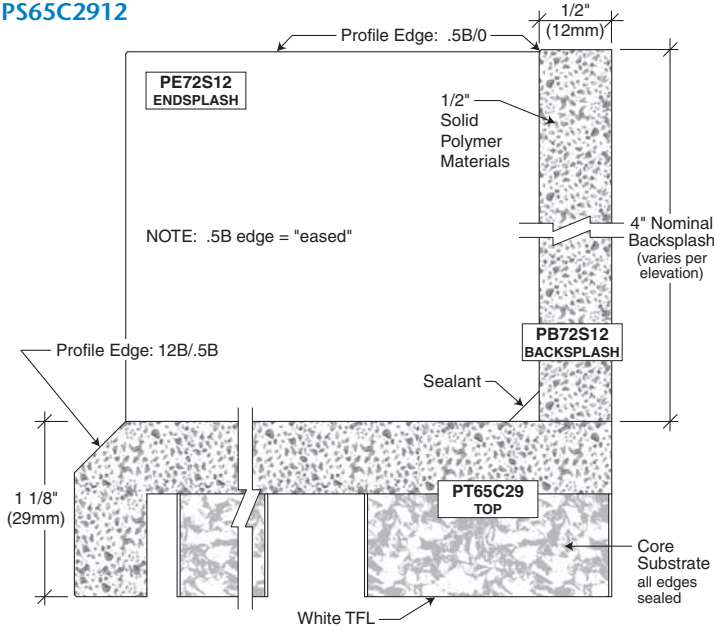

PS65 SOLID SURFACE

- Solid surface (polymer) materials
- 12B/.5B profile edge top
- Applied .5B/0 profile edge backsplash and endsplash

Series/Core Substrate Codes:

- PS65C** TSCA particleboard
- PS65M** Moisture-resistant/NAF particleboard
- PS65F** Fire-rated particleboard
- PS65D** Medium Density Fiberboard (MDF)
- PS65G** Moisture-resistant/NAF MDF
- PS65H** Fire-rated MDF
- PS65P** Plywood

Backsplash and Endsplash Model/Core Codes:

- PB72S** Solid
- PE72S** Solid

PS65C, PS65M, PS65F, PS65D, PS65G, PS65H and **PS65P** available countertop thicknesses:
 29mm (1-1/8")
 38mm (1-1/2")

Drop edge available upon special request in 1/2" increments, from 2" to 6". Drop edge not available over casework.

PS66

Example:
 PS66C2912

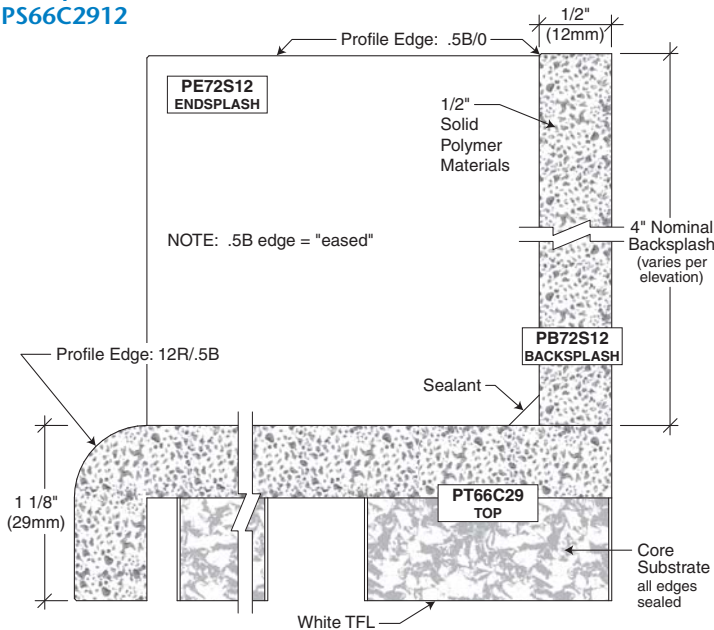

PS66 SOLID SURFACE

- Solid surface (polymer) materials
- 12R/.5B profile edge top
- Applied .5B/0 profile edge backsplash and endsplash

Series/Core Substrate Codes:

- PS66C** TSCA particleboard
- PS66M** Moisture-resistant/NAF particleboard
- PS66F** Fire-rated particleboard
- PS66D** Medium Density Fiberboard (MDF)
- PS66G** Moisture-resistant/NAF MDF
- PS66H** Fire-rated MDF
- PS66P** Plywood

Backsplash and Endsplash Model/Core Codes:

- PB72S** Solid
- PE72S** Solid

PS66C, PS66M, PS66F, PS66D, PS66G, PS66H and **PS66P** available countertop thicknesses:
 29mm (1-1/8")
 38mm (1-1/2")

Drop edge available upon special request in 1/2" increments, from 2" to 6". Drop edge not available over casework.

PT = Solid Surface Top
PB = Solid Surface Backsplash
PE = Solid Surface Endsplash

PS67

Example:
PS67C2912

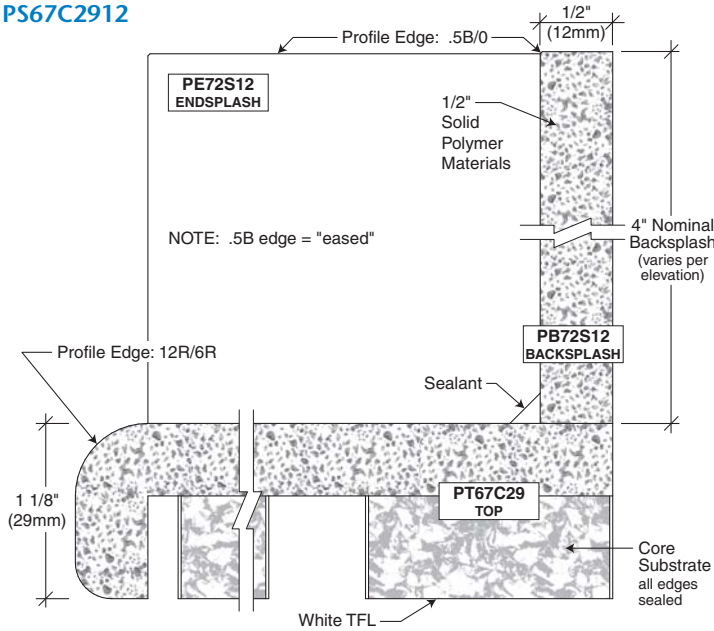

PS67 SOLID SURFACE

- Solid surface (polymer) materials
- 12R/6R profile edge top
- Applied .5B/0 profile edge backsplash and endsplash

Series/Core Substrate Codes:

- PS67C** TSCA particleboard
PS67M Moisture-resistant/NAF particleboard
PS67F Fire-rated particleboard
PS67D Medium Density Fiberboard (MDF)
PS67G Moisture-resistant/NAF MDF
PS67H Fire-rated MDF
PS67P Plywood

Backsplash and Endsplash Model/Core Codes:

- PB72S** Solid
PE72S Solid

PS67C, PS67M, PS67F, PS67D, PS67G, PS67H and **PS67P** available countertop thicknesses:
29mm (1-1/8")
38mm (1-1/2")

Drop edge available upon special request in 1/2" increments, from 2" to 6". Drop edge not available over casework.

PS68

Example:
PS68C2912

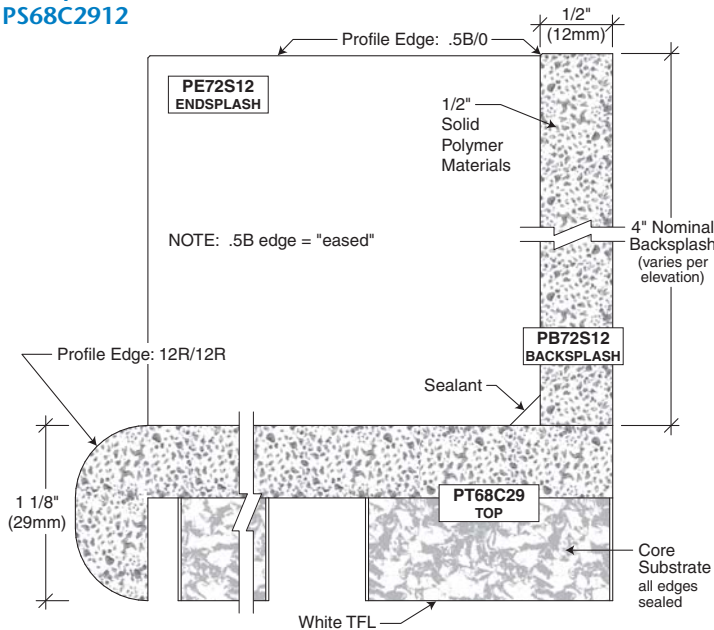

PS68 SOLID SURFACE

- Solid surface (polymer) materials
- 12R/12R profile edge top
- Applied .5B/0 profile edge backsplash and endsplash

Series/Core Substrate Codes:

- PS68C** TSCA particleboard
PS68M Moisture-resistant/NAF particleboard
PS68F Fire-rated particleboard
PS68D Medium Density Fiberboard (MDF)
PS68G Moisture-resistant/NAF MDF
PS68H Fire-rated MDF
PS68P Plywood

Backsplash and Endsplash Model/Core Codes:

- PB72S** Solid
PE72S Solid

PS68C, PS68M, PS68F, PS68D, PS68G, PS68H and **PS68P** available countertop thicknesses:
29mm (1-1/8")
38mm (1-1/2")

Drop edge available upon special request in 1/2" increments, from 2" to 6". Drop edge not available over casework.

COUNTERTOPS

Solid Surface Series

PT = Solid Surface Top
 PB = Solid Surface Backsplash
 PE = Solid Surface Endsplash



PS72

Example:
 PS72C2912

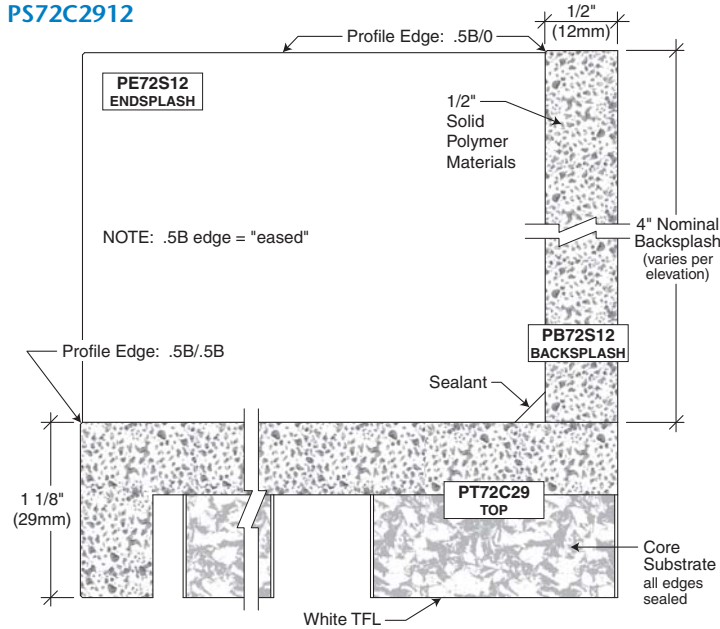

PS72 SOLID SURFACE

- Solid surface (polymer) materials
- .5B/.5B profile edge top
- Applied .5B/0 profile edge backsplash and endsplash

Series/Core Substrate Codes:

- PS72C TSCA particleboard
- PS72M Moisture-resistant/NAF particleboard
- PS72F Fire-rated particleboard
- PS72D Medium Density Fiberboard (MDF)
- PS72G Moisture-resistant/NAF MDF
- PS72H Fire-rated MDF
- PS72P Plywood

Backsplash and Endsplash Model/Core Codes:

- PB72S Solid
- PE72S Solid

PS72C, PS72M, PS72F, PS72D, PS72G, PS72H and PS72P available countertop thicknesses:

- 29mm (1-1/8")
- 38mm (1-1/2")

Drop edge available upon special request in 1/2" increments, from 2" to 6". Drop edge not available over casework.

PT = Solid Surface Top
PE = Solid Surface Endsplash

PS79

(Stevens preferred)

Example:
PS79C2912

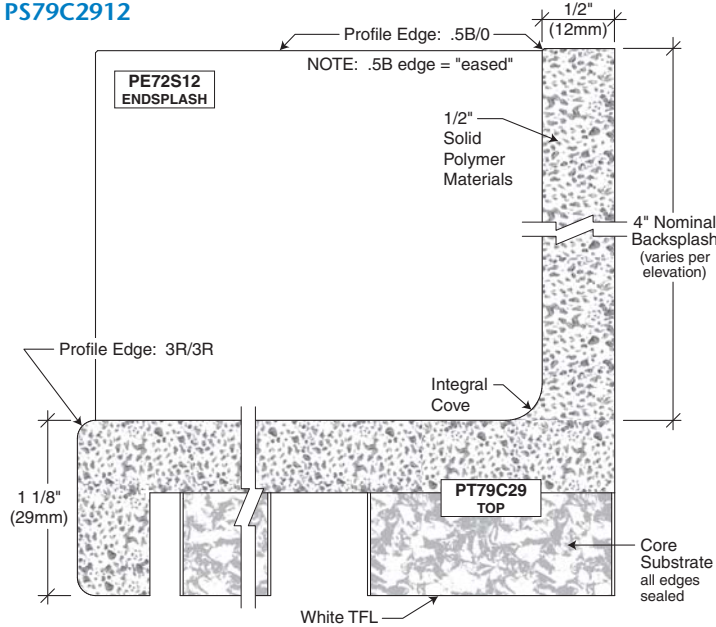

PS79 SOLID SURFACE

- Solid surface (polymer) materials
- 3R/3R profile edge top
- Integral cove .5B/0 profile edge backsplash
- Applied .5B/0 profile edge endsplash

Series/Core Substrate Codes:

- PS79C** TSCA particleboard
- PS79M** Moisture-resistant/NAF particleboard
- PS79F** Fire-rated particleboard
- PS79D** Medium Density Fiberboard (MDF)
- PS79G** Moisture-resistant/NAF MDF
- PS79H** Fire-rated MDF
- PS79P** Plywood

Endsplash Model/Core Code:

PE72S Solid

PS79C, PS79M, PS79F, PS79D, PS79G, PS79H and **PS79P** available countertop thicknesses:
29mm (1-1/8")
38mm (1-1/2")

Drop edge available upon special request in 1/2" increments, from 2" to 6". Drop edge not available over casework.

PS80

Example:
PS80C2912

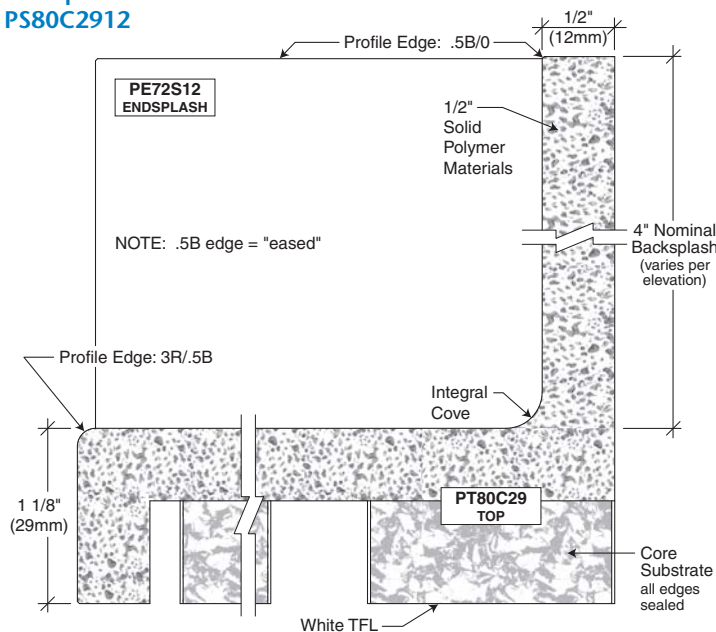

PS80 SOLID SURFACE

- Solid surface (polymer) materials
- 3R/.5B profile edge top
- Integral cove .5B/0 profile edge backsplash
- Applied .5B/0 profile edge endsplash

Series/Core Substrate Codes:

- PS80C** TSCA particleboard
- PS80M** Moisture-resistant/NAF particleboard
- PS80F** Fire-rated particleboard
- PS80D** Medium Density Fiberboard (MDF)
- PS80G** Moisture-resistant/NAF MDF
- PS80H** Fire-rated MDF
- PS80P** Plywood

Endsplash Model/Core Code:

PE72S Solid

PS80C, PS80M, PS80F, PS80D, PS80G, PS80H and **PS80P** available countertop thicknesses:
29mm (1-1/8")
38mm (1-1/2")

Drop edge available upon special request in 1/2" increments, from 2" to 6". Drop edge not available over casework.

COUNTERTOPS

Solid Surface Series

PT = Solid Surface Top
PE = Solid Surface Endsplash



PS81

Example:
PS81C2912

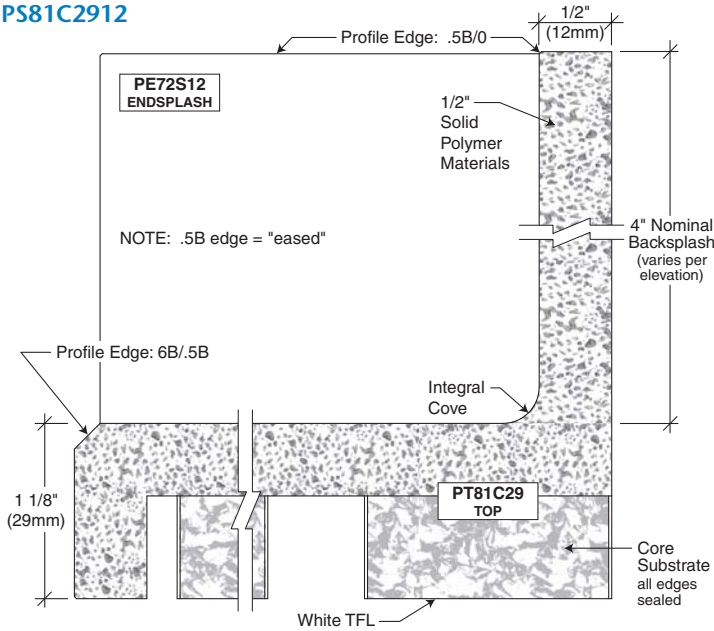

PS81 SOLID SURFACE

- Solid surface (polymer) materials
- 6B/.5B profile edge top
- Integral cove .5B/0 profile edge backsplash
- Applied .5B/0 profile edge endsplash

Series/Core Substrate Codes:

- PS81C** TSCA particleboard
- PS81M** Moisture-resistant/NAF particleboard
- PS81F** Fire-rated particleboard
- PS81D** Medium Density Fiberboard (MDF)
- PS81G** Moisture-resistant/NAF MDF
- PS81H** Fire-rated MDF
- PS81P** Plywood

Endsplash Model/Core Code:

PE72S Solid

PS81C, PS81M, PS81F, PS81D, PS81G, PS81H and **PS81P** available countertop thicknesses:
 29mm (1-1/8")
 38mm (1-1/2")

Drop edge available upon special request in 1/2" increments, from 2" to 6". Drop edge not available over casework.

PS82

Example:
PS82C2912

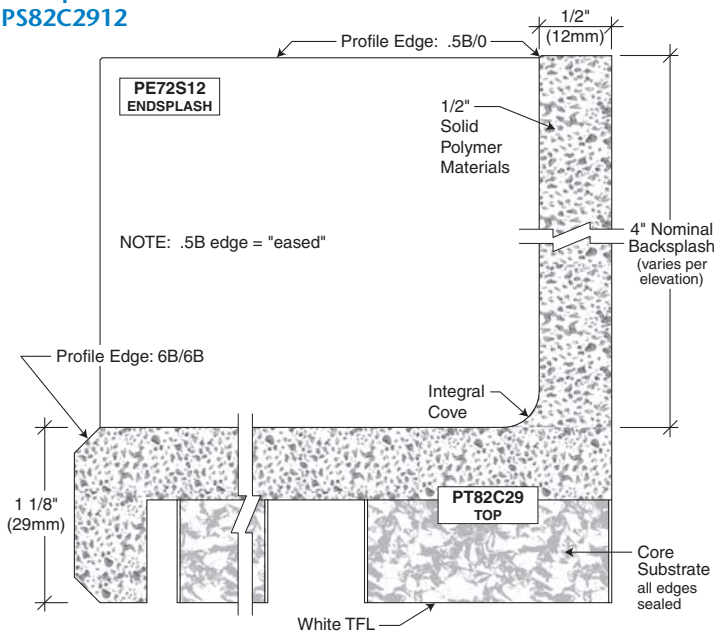

PS82 SOLID SURFACE

- Solid surface (polymer) materials
- 6B/6B profile edge top
- Integral cove .5B/0 profile edge backsplash
- Applied .5B/0 profile edge endsplash

Series/Core Substrate Codes:

- PS82C** TSCA particleboard
- PS82M** Moisture-resistant/NAF particleboard
- PS82F** Fire-rated particleboard
- PS82D** Medium Density Fiberboard (MDF)
- PS82G** Moisture-resistant/NAF MDF
- PS82H** Fire-rated MDF
- PS82P** Plywood

Endsplash Model/Core Code:

PE72S Solid

PS82C, PS82M, PS82F, PS82D, PS82G, PS82H and **PS82P** available countertop thicknesses:
 29mm (1-1/8")
 38mm (1-1/2")

Drop edge available upon special request in 1/2" increments, from 2" to 6". Drop edge not available over casework.

PT = Solid Surface Top
PE = Solid Surface Endsplash

PS83

Example:
PS83C2912

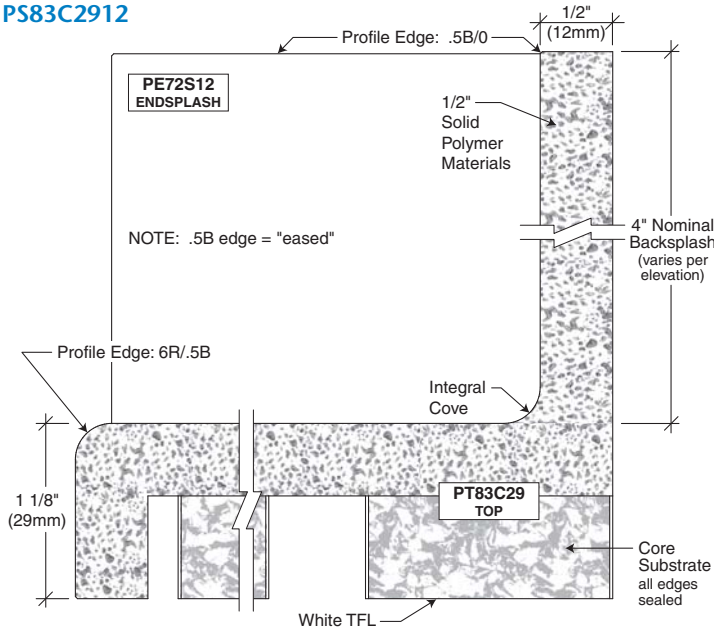

PS83 SOLID SURFACE

- Solid surface (polymer) materials
- 6R/.5B profile edge top
- Integral coved .5B/0 profile edge backsplash
- Applied .5B/0 profile edge endsplash

Series/Core Substrate Codes:

- PS83C** TSCA particleboard
PS83M Moisture-resistant/NAF particleboard
PS83F Fire-rated particleboard
PS83D Medium Density Fiberboard (MDF)
PS83G Moisture-resistant/NAF MDF
PS83H Fire-rated MDF
PS83P Plywood

Endsplash Model/Core Code:

PE72S Solid

PS83C, PS83M, PS83F, PS83D, PS83G, PS83H and **PS83P** available countertop thicknesses:
 29mm (1-1/8")
 38mm (1-1/2")

Drop edge available upon special request in 1/2" increments, from 2" to 6". Drop edge not available over casework.

PS84

Example:
PS84C2912

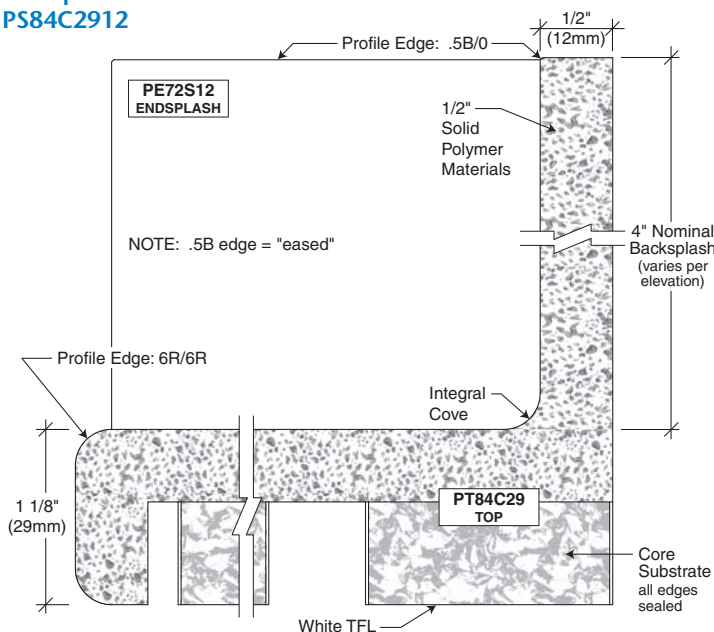

PS84 SOLID SURFACE

- Solid surface (polymer) materials
- 6R/6R profile edge top
- Integral coved .5B/0 profile edge backsplash
- Applied .5B/0 profile edge endsplash

Series/Core Substrate Codes:

- PS84C** TSCA particleboard
PS84M Moisture-resistant/NAF particleboard
PS84F Fire-rated particleboard
PS84D Medium Density Fiberboard (MDF)
PS84G Moisture-resistant/NAF MDF
PS84H Fire-rated MDF
PS84P Plywood

Endsplash Model/Core Code:

PE72S Solid

PS84C, PS84M, PS84F, PS84D, PS84G, PS84H and **PS84P** available countertop thicknesses:
 29mm (1-1/8")
 38mm (1-1/2")

Drop edge available upon special request in 1/2" increments, from 2" to 6". Drop edge not available over casework.

COUNTERTOPS

Solid Surface Series

PT = Solid Surface Top
PE = Solid Surface Endsplash



PS85

Example:
PS85C2912

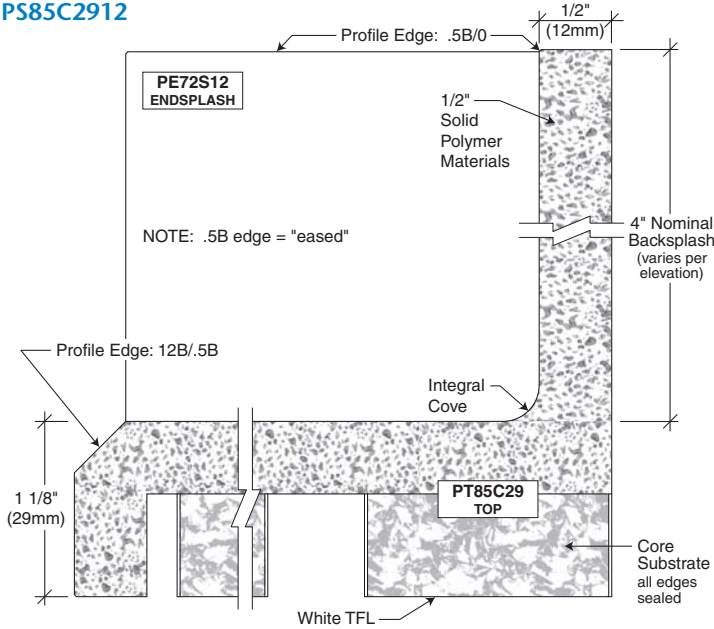

PS85 SOLID SURFACE

- Solid surface (polymer) materials
- 12B/.5B profile edge top
- Integral cove .5B/0 profile edge backsplash
- Applied .5B/0 profile edge endsplash

Series/Core Substrate Codes:

- PS85C** TSCA particleboard
- PS85M** Moisture-resistant/NAF particleboard
- PS85F** Fire-rated particleboard
- PS85D** Medium Density Fiberboard (MDF)
- PS85G** Moisture-resistant/NAF MDF
- PS85H** Fire-rated MDF
- PS85P** Plywood

Endsplash Model/Core Code:

PE72S Solid

PS85C, PS85M, PS85F, PS85D, PS85G, PS85H and **PS85P** available countertop thicknesses:
29mm (1-1/8")
38mm (1-1/2")

Drop edge available upon special request in 1/2" increments, from 2" to 6". Drop edge not available over casework.

PS86

Example:
PS86C2912

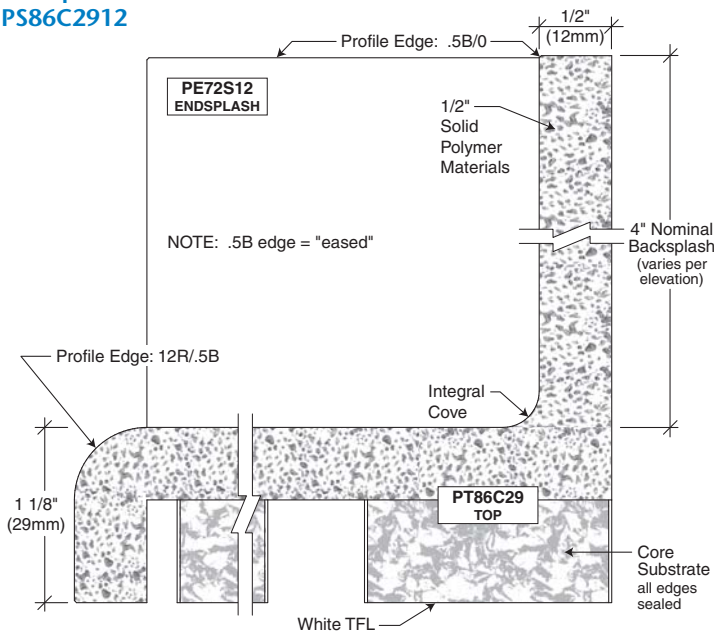

PS86 SOLID SURFACE

- Solid surface (polymer) materials
- 12R/.5B profile edge top
- Integral cove .5B/0 profile edge backsplash
- Applied .5B/0 profile edge endsplash

Series/Core Substrate Codes:

- PS86C** TSCA particleboard
- PS86M** Moisture-resistant/NAF particleboard
- PS86F** Fire-rated particleboard
- PS86D** Medium Density Fiberboard (MDF)
- PS86G** Moisture-resistant/NAF MDF
- PS86H** Fire-rated MDF
- PS86P** Plywood

Endsplash Model/Core Code:

PE72S Solid

PS86C, PS86M, PS86F, PS86D, PS86G, PS86H and **PS86P** available countertop thicknesses:
29mm (1-1/8")
38mm (1-1/2")

Drop edge available upon special request in 1/2" increments, from 2" to 6". Drop edge not available over casework.

PT = Solid Surface Top
PE = Solid Surface Endsplash

PS87

Example:
PS87C2912

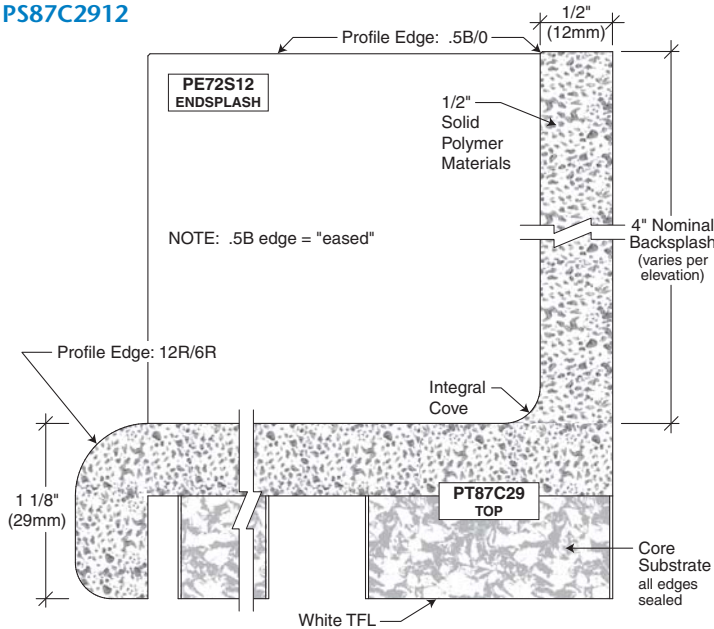

PS87 SOLID SURFACE

- Solid surface (polymer) materials
- 12R/6R profile edge top
- Integral cove .5B/0 profile edge backsplash
- Applied .5B/0 profile edge endsplash

Series/Core Substrate Codes:

- PS87C** TSCA particleboard
PS87M Moisture-resistant/NAF particleboard
PS87F Fire-rated particleboard
PS87D Medium Density Fiberboard (MDF)
PS87G Moisture-resistant/NAF MDF
PS87H Fire-rated MDF
PS87P Plywood

Endsplash Model/Core Code:

PE72S Solid

PS87C, PS87M, PS87F, PS87D, PS87G, PS87H and **PS87P** available countertop thicknesses:
 29mm (1-1/8")
 38mm (1-1/2")

Drop edge available upon special request in 1/2" increments, from 2" to 6". Drop edge not available over casework.

PS88

Example:
PS88C2912

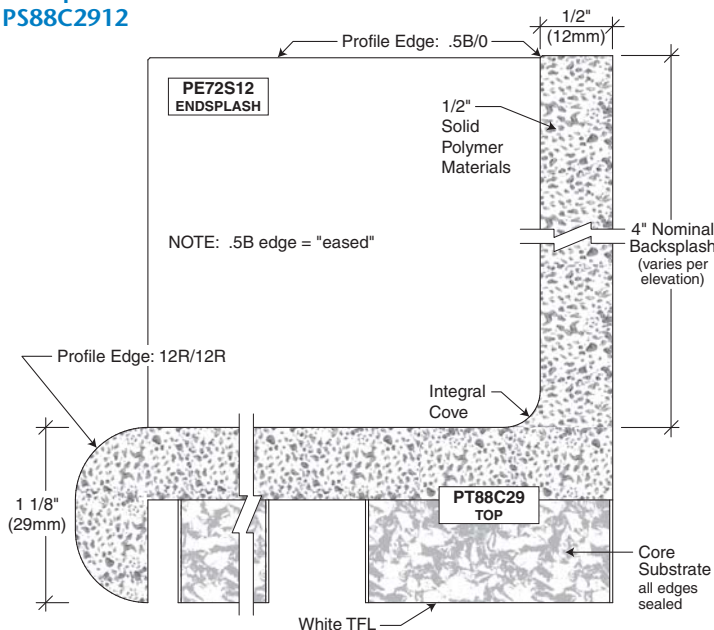

PS88 SOLID SURFACE

- Solid surface (polymer) materials
- 12R/12R profile edge top
- Integral cove .5B/0 profile edge backsplash
- Applied .5B/0 profile edge endsplash

Series/Core Substrate Codes:

- PS88C** TSCA particleboard
PS88M Moisture-resistant/NAF particleboard
PS88F Fire-rated particleboard
PS88D Medium Density Fiberboard (MDF)
PS88G Moisture-resistant/NAF MDF
PS88H Fire-rated MDF
PS88P Plywood

Endsplash Model/Core Code:

PE72S Solid

PS88C, PS88M, PS88F, PS88D, PS88G, PS88H and **PS88P** available countertop thicknesses:
 29mm (1-1/8")
 38mm (1-1/2")

Drop edge available upon special request in 1/2" increments, from 2" to 6". Drop edge not available over casework.

COUNTERTOPS

Solid Surface Series

PT = Solid Surface Top
PE = Solid Surface Endsplash



PS92

Example:
PS92C2912

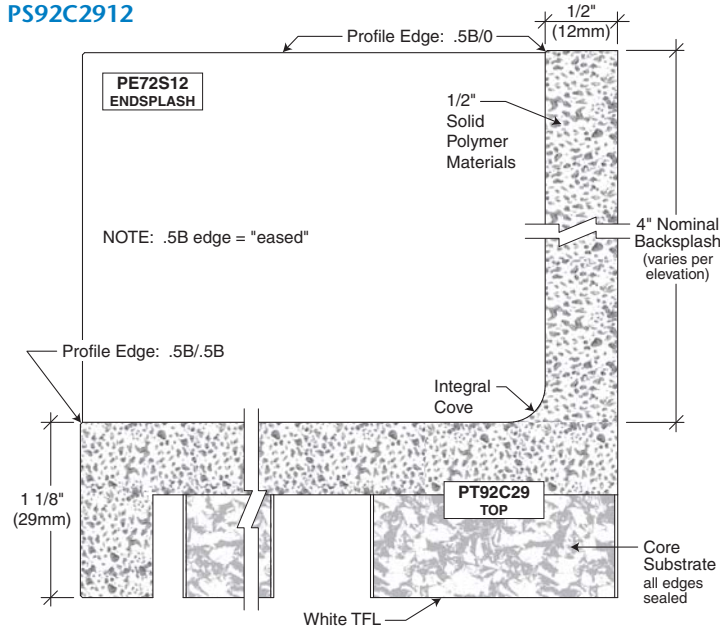

PS92 SOLID SURFACE

- Solid surface (polymer) materials
- .5B/.5B profile edge top
- Integral coved .5B/0 profile edge backsplash
- Applied .5B/0 profile edge endsplash

Series/Core Substrate Codes:

- PS92C** TSCA particleboard
- PS92M** Moisture-resistant/NAF particleboard
- PS92F** Fire-rated particleboard
- PS92D** Medium Density Fiberboard (MDF)
- PS92G** Moisture-resistant/NAF MDF
- PS92H** Fire-rated MDF
- PS92P** Plywood

Endsplash Model/Core Code:

PE72S Solid

PS92C, PS92M, PS92F, PS92D, PS92G, PS92H and **PS92P** available countertop thicknesses:

- 29mm (1-1/8")
- 38mm (1-1/2")

Drop edge available upon special request in 1/2" increments, from 2" to 6". Drop edge not available over casework.

ET = Epoxy Top
EB = Epoxy Backsplash
EE = Epoxy Endsplash

ES00

Example:
ES00AW1919

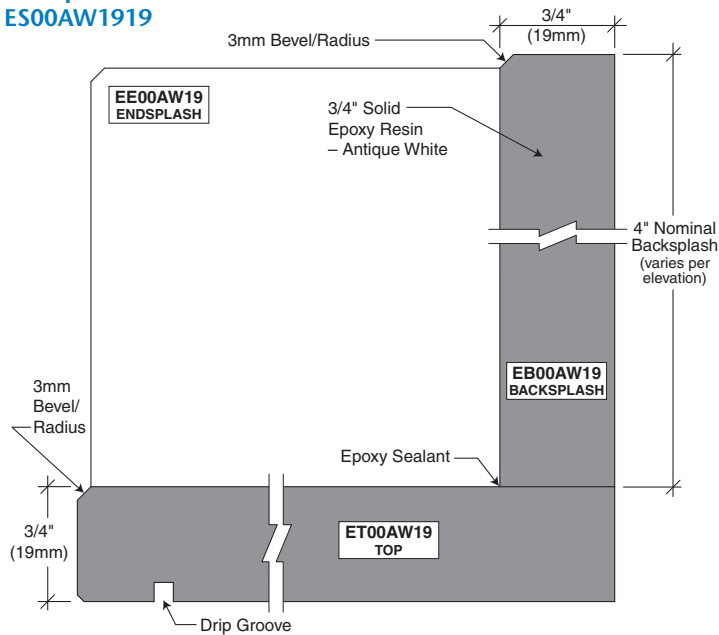

ES00 EPOXY RESIN

- Solid epoxy resin
- 3mm bevel/radius edges with smooth edge finish
- Applied backsplash and endsplash
- Drip groove
- Butt joints and attachment with field applied epoxy sealant and adhesives
- Epoxy resin coordinated sinks where specified
- Factory fabricated cutouts and drillings

Series/Color Codes:

ES00AW Antique White
ES00BL Black
ES00DK Dark Khaki
ES00GR Grey
ES00PL Platinum
ES00SA Sandstone

ES00 available countertop thicknesses:
19mm (3/4")
25mm (1")

ES02

Example:
ES02AW2519

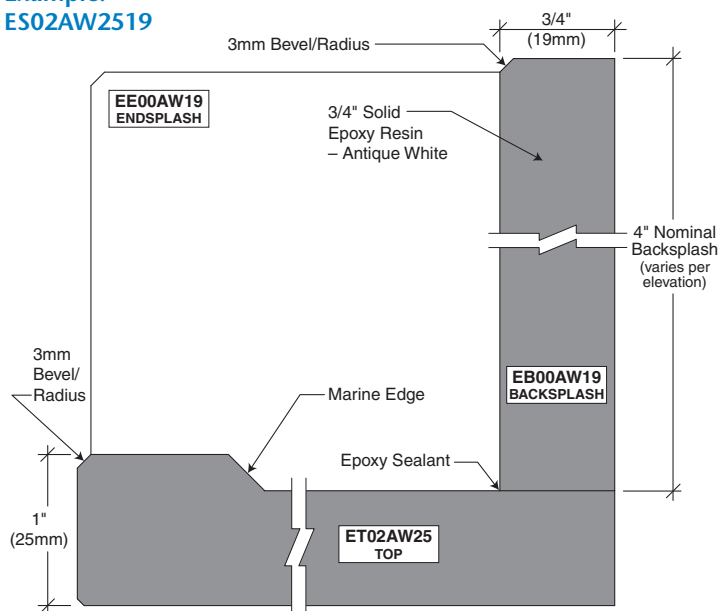

ES02 EPOXY RESIN

- Solid epoxy resin
- Lipped marine edge
- 3mm bevel/radius edges with smooth edge finish
- Applied backsplash and endsplash
- Butt joints and attachment with field applied epoxy sealant and adhesives
- Epoxy resin coordinated sinks where specified
- Factory fabricated cutouts and drillings

Series/Color Codes:

ES02AW Antique White
ES02BL Black
ES02DK Dark Khaki
ES02GR Grey
ES02PL Platinum
ES02SA Sandstone

ES02 available countertop thickness:
25mm (1")

COUNTERTOPS

Hardwood Series

WT = Hardwood Top
WB = Hardwood Backsplash
WE = Hardwood Endsplash



WD00

Example:
WD00S3819

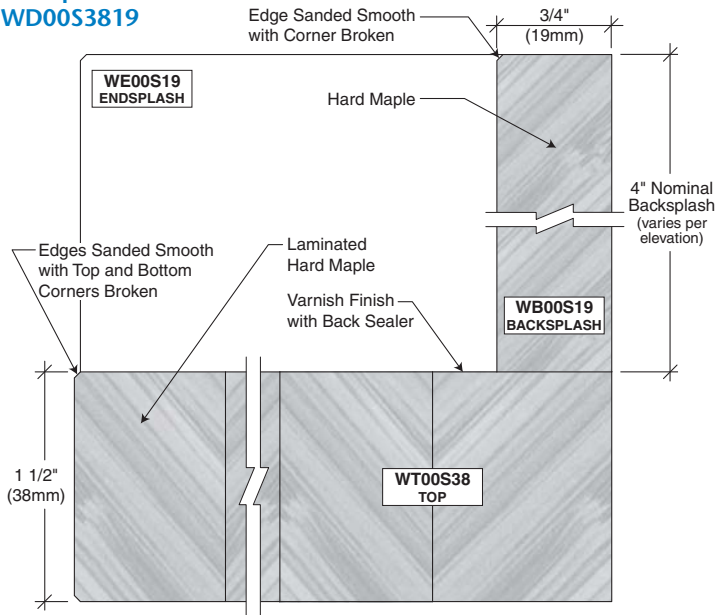

WD00 HARDWOOD

- Fabricated from laminated kiln dried hard maple lumber
- Industrial grade with butt joints and edge grain fabrication (butcher block) design
- Edges sanded smooth with top and bottom corners broken
- Faces and edges sealed with varnish finish

Series/Core Code:

WD00S Solid hard maple

WD00S available countertop thicknesses:

38mm (1-1/2")

44mm (1-3/4")

Note: Laminated maple lumber tops are susceptible to changes due to moisture, heat and cold conditions. Warpage and edge splitting may occur under unusual field conditions. Wood tops should only be delivered and installed after project HVAC systems are working and balanced for normal interior conditions. Never store or use in high or low humidity with cyclical conditions.

ST = Stainless Steel Top

SS00

Example:
SS00P2725

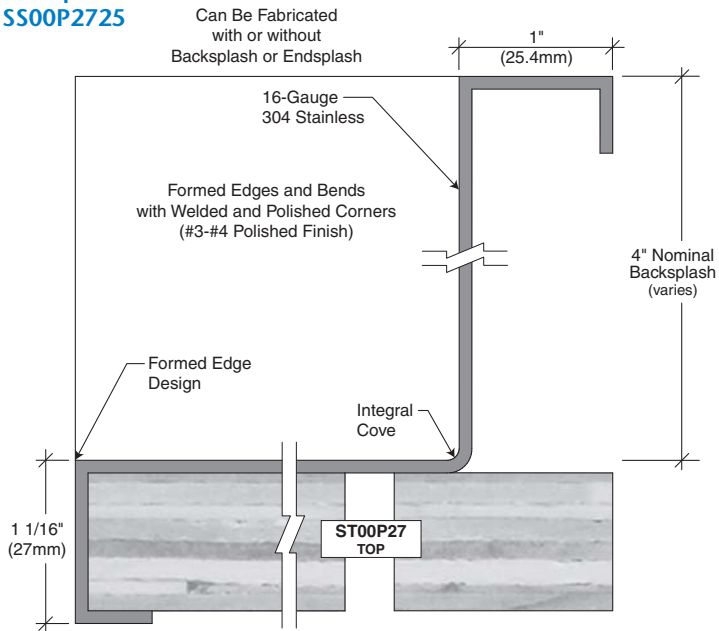

SS00 STAINLESS STEEL

- Formed edge design with integral cove
- Fabricated from 16-gauge 304 stainless steel
- Formed edges and bends with welded and polished corners
- Can be fabricated with or without backsplash or endsplash

Series/Core Codes:

SS00P Plywood
SS00R Stainless Steel Rail

SS00P and **SS00R** available countertop thickness: 27mm (1-1/16")

Example:
SS00R2725

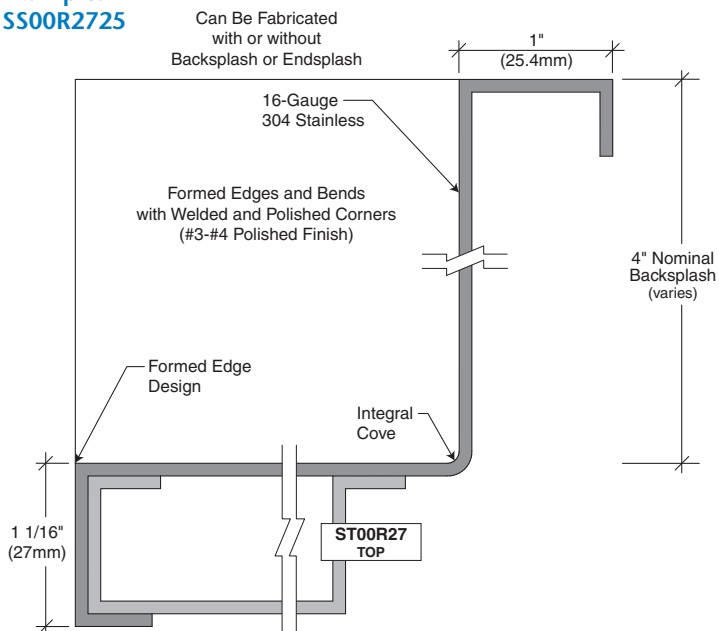

COUNTERTOPS

Stainless Steel Series

ST = Stainless Steel Top



SS01

Example:
SS01P3225

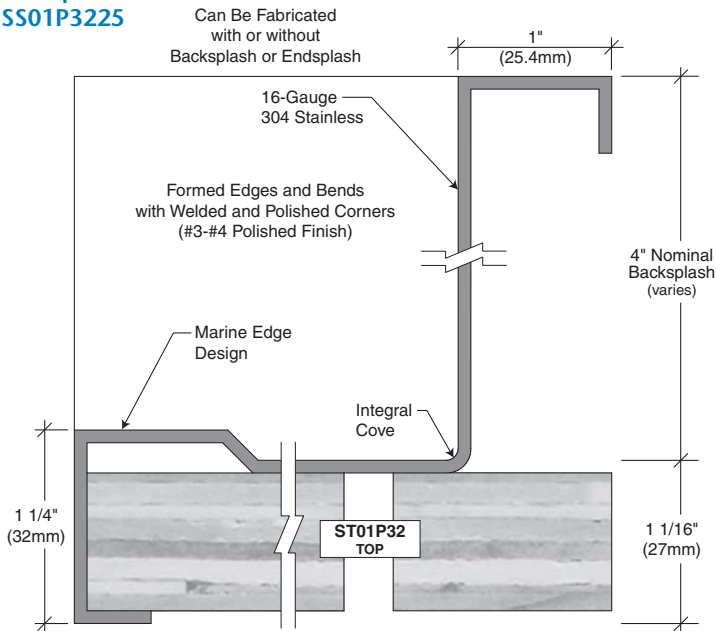

SS01 STAINLESS STEEL

- Marine edge design with integral cove
- Fabricated from 16-gauge 304 stainless steel
- Formed edges and bends with welded and polished corners
- Can be fabricated with or without backsplash or endsplash

Series/Core Codes:

SS01P Plywood

SS01R Stainless Steel Rail

SS01P and SS01R available countertop thickness:
32mm (1-1/4")

Example:
SS01R3225

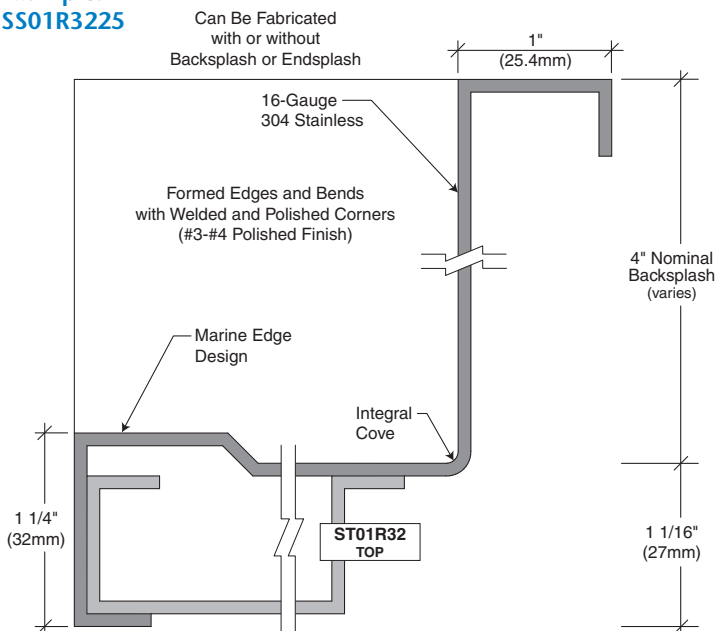

AT = Phenolic Top
AB = Phenolic Backsplash
AE = Phenolic Endsplash

AP00

Example:
AP00S1919

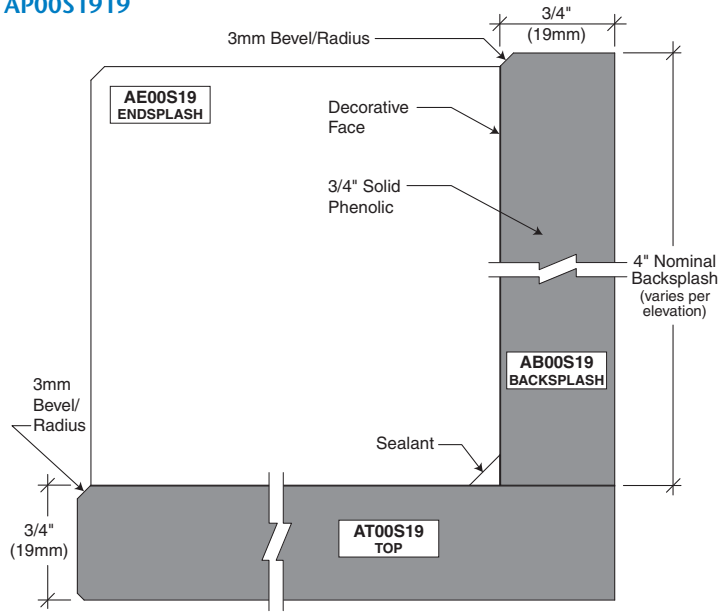

AP00 PHENOLIC

- Solid phenolic core with decorative face pattern
- 3mm bevel/radius edges, polished for consistent edge look
- Applied backsplash and endsplash

Series/Core Code:

AP00S Solid

AP00S available countertop thickness:

- 19mm (3/4")
- 25mm (1")

AP01

Example:
AP01S1919

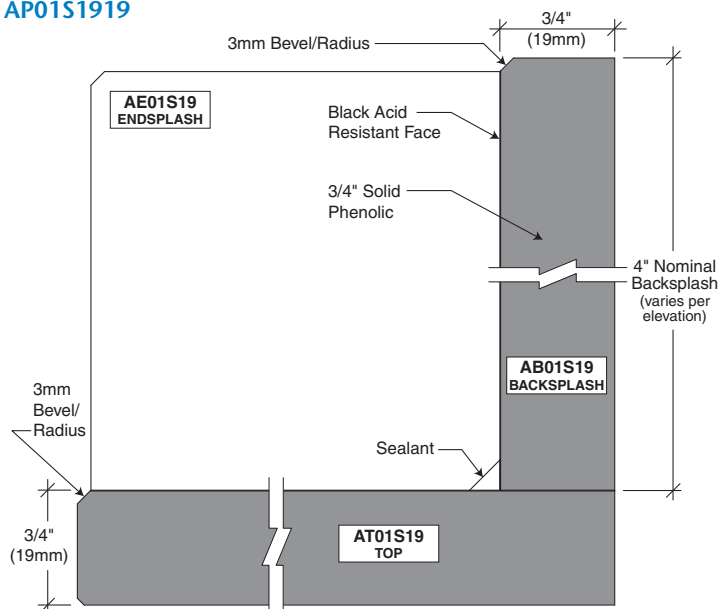

AP01 PHENOLIC

- Solid phenolic core with black acid resistant face
- 3mm bevel/radius edges, polished for consistent edge look
- Applied backsplash and endsplash

Series/Core Code:

AP01S Solid

AP01S available countertop thickness:

- 19mm (3/4")
- 25mm (1")

AT = Phenolic Top
AB = Phenolic Backsplash
AE = Phenolic Endsplash

AP04

Example:
AP04S1919

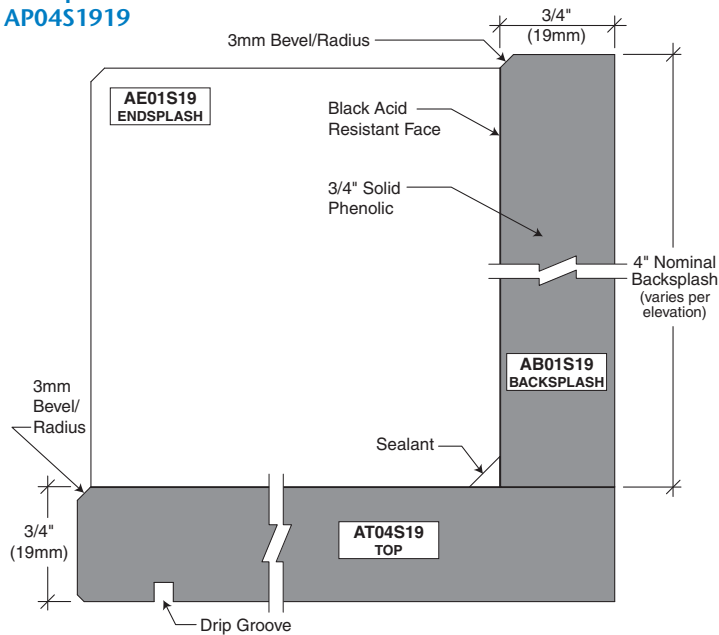

AP04 PHENOLIC

- Solid phenolic core with black acid resistant face
- 3mm bevel/radius edges, polished for consistent edge look
- Applied backsplash and endsplash
- Drip groove

Series/Core Code:

AP04S Solid

AP04S available countertop thickness:

- 19mm (3/4")
- 25mm (1")

AP05

Example:
AP05S1919

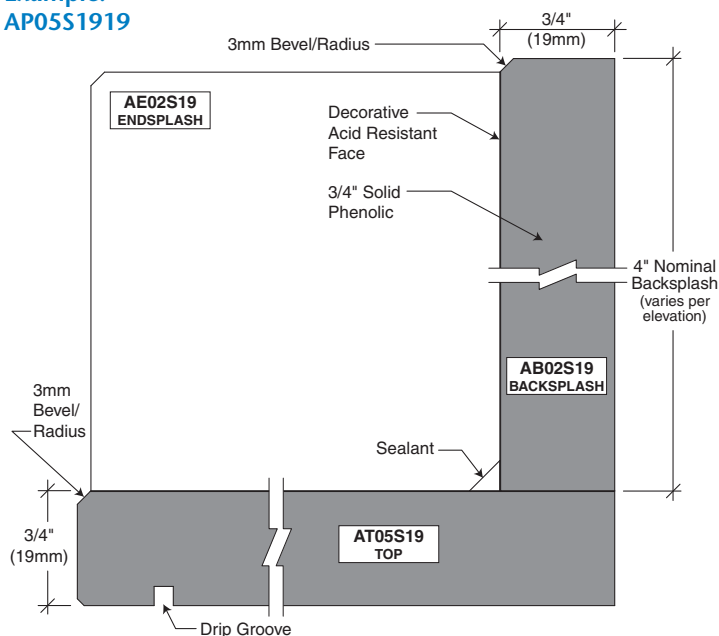

AP05 PHENOLIC

- Solid phenolic core with decorative acid resistant face
- 3mm bevel/radius edges, polished for consistent edge look
- Applied backsplash and endsplash
- Drip groove

Series/Core Code:

AP05S Solid

AP05S available countertop thickness:

- 19mm (3/4")
- 25mm (1")

COUNTERTOPS

Granite Series

GT = Granite Top
 GB = Granite Backsplash
 GE = Granite Endsplash



GS00

Example:
 GS00S2020

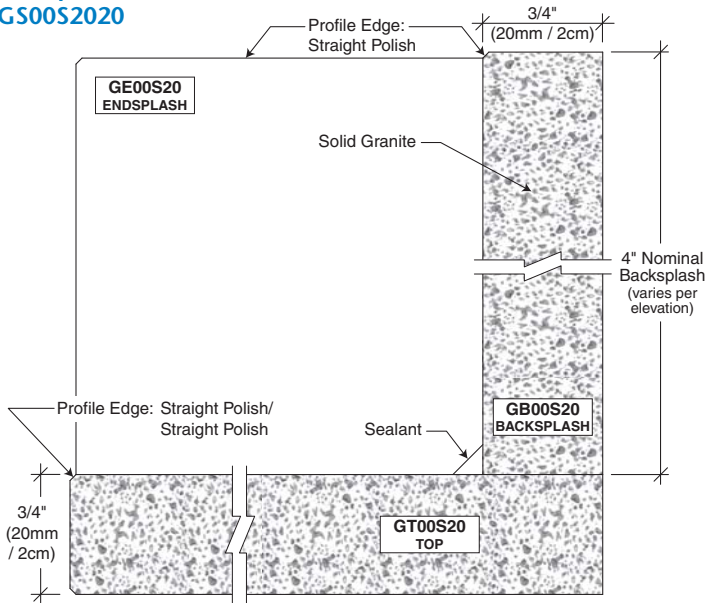

GS00 GRANITE

- Solid granite
- Straight Polish/Straight Polish profile edge top
- Applied Straight Polish profile edge backsplash and endsplash

Series/Core Code:

GS00S Solid

GS00S available countertop thicknesses:

- 20mm / 2cm (3/4")
- 30mm / 3cm (1-3/16")

GS01

Example:
 GS01S2020

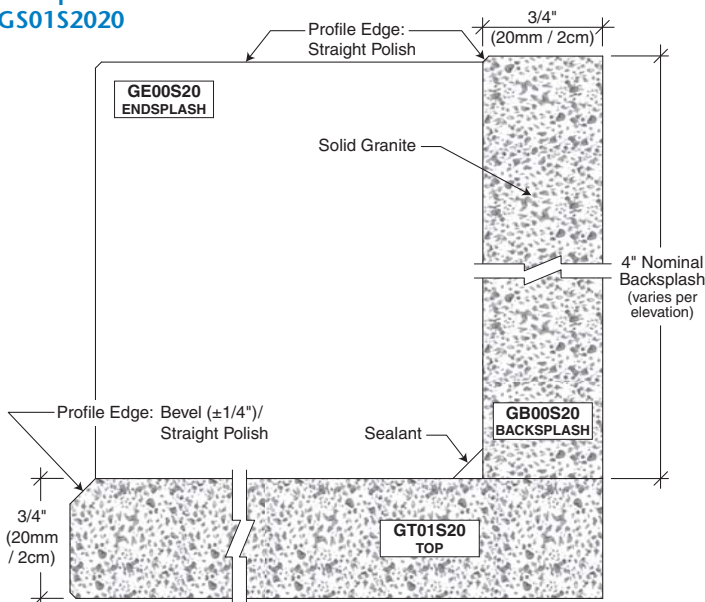

GS01 GRANITE

- Solid granite
- Bevel ($\pm 1/4$ ")/Straight Polish profile edge top
- Applied Straight Polish profile edge backsplash and endsplash

Series/Core Code:

GS01S Solid

GS01S available countertop thicknesses:

- 20mm / 2cm (3/4")
- 30mm / 3cm (1-3/16")

GT = Granite Top
GB = Granite Backsplash
GE = Granite Endsplash

GS02

Example:
GS02S2020

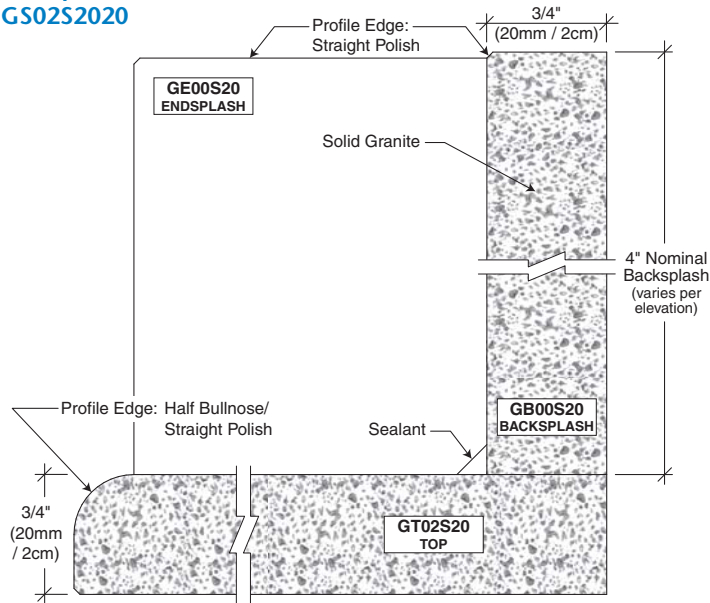

GS02 GRANITE

- Solid granite
- Half Bullnose/Straight Polish profile edge top
- Applied Straight Polish profile edge backsplash and endsplash

Series/Core Code:

GS02S Solid

GS02S available countertop thicknesses:

- 20mm / 2cm (3/4")
- 30mm / 3cm (1-3/16")

COUNTERTOPS

Marble Series

MT = Marble Top
 MB = Marble Backsplash
 ME = Marble Endsplash



MS00

Example:
 MS00S2020

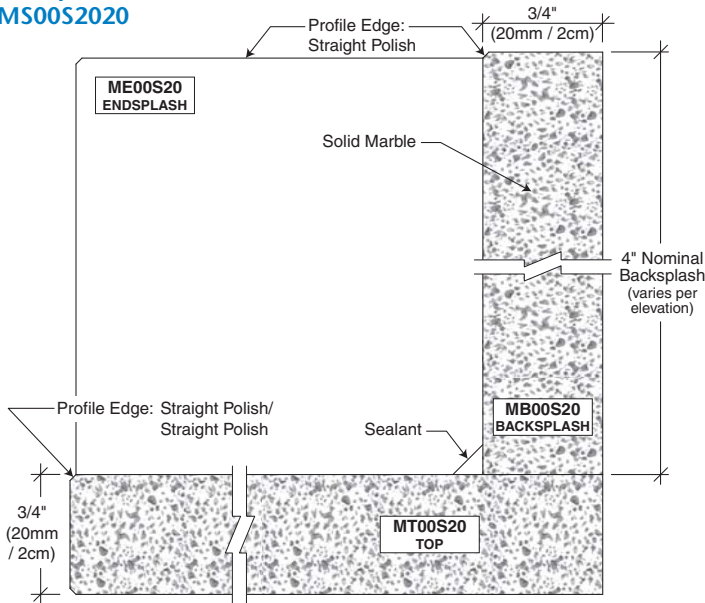

MS00 MARBLE

- Solid marble
- Straight Polish/Straight Polish profile edge top
- Applied Straight Polish profile edge backsplash and endsplash

Series/Core Code:

MS00S Solid

MS00S available countertop thicknesses:

- 20mm / 2cm (3/4")
- 30mm / 3cm (1-3/16")

MS01

Example:
 MS01S2020

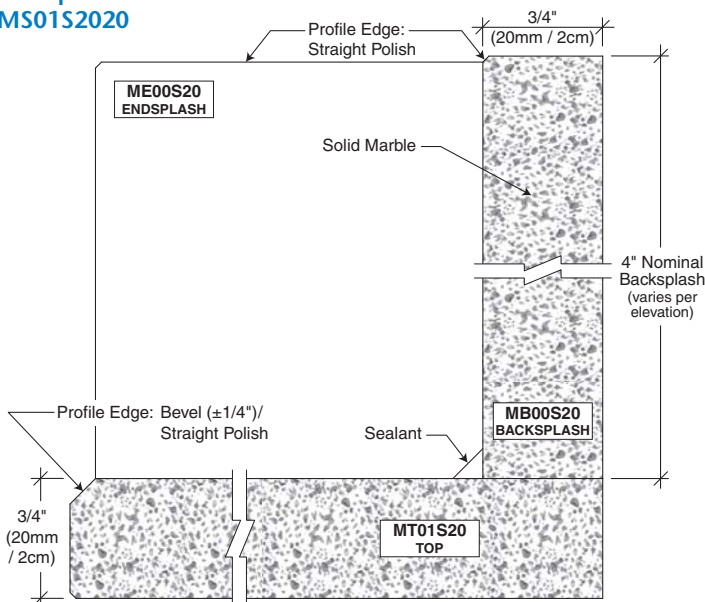

MS01 MARBLE

- Solid marble
- Bevel ($\pm 1/4"$)/Straight Polish profile edge top
- Applied Straight Polish profile edge backsplash and endsplash

Series/Core Code:

MS01S Solid

MS01S available countertop thicknesses:

- 20mm / 2cm (3/4")
- 30mm / 3cm (1-3/16")

MT = Marble Top
MB = Marble Backsplash
ME = Marble Endsplash

MS02

Example:
MS02S2020

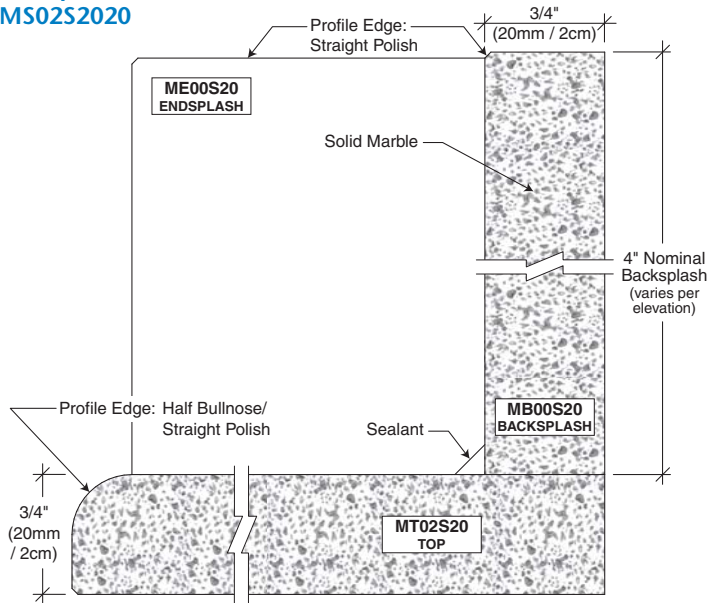

MS02 MARBLE

- Solid marble
- Half Bullnose/Straight Polish profile edge top
- Applied Straight Polish profile edge backsplash and endsplash

Series/Core Code:

MS02S Solid

MS02S available countertop thicknesses:

- 20mm / 2cm (3/4")
- 30mm / 3cm (1-3/16")

COUNTERTOPS

Quartz Series

QT = Quartz Top
QB = Quartz Backsplash
QE = Quartz Endsplash



QS00

Example:
QS00S2020

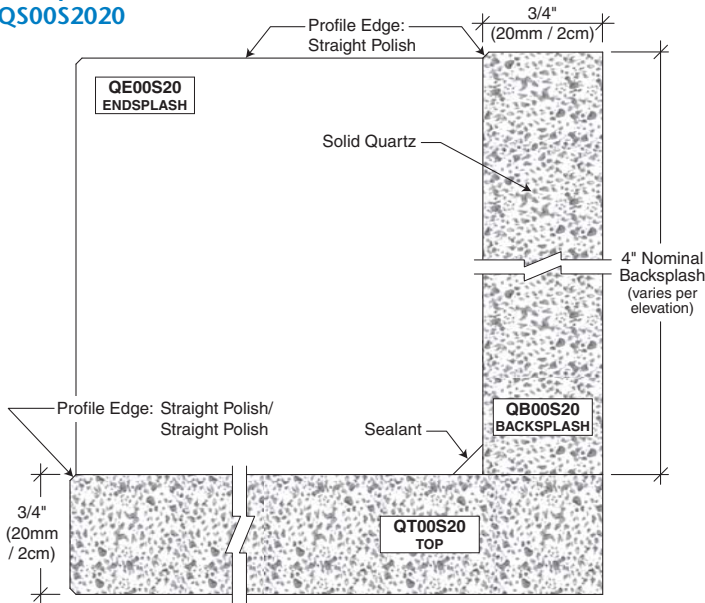

QS00 QUARTZ

- Solid quartz
- Straight Polish/Straight Polish profile edge top
- Applied Straight Polish profile edge backsplash and endsplash

Series/Core Code:

QS00S Solid

QS00S available countertop thicknesses:

- 20mm / 2cm (3/4")
- 30mm / 3cm (1-3/16")

QS01

Example:
QS01S2020

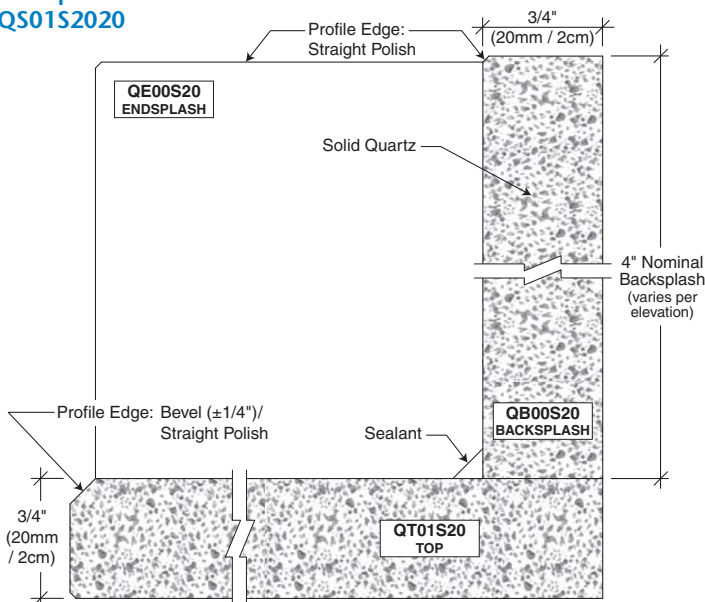

QS01 QUARTZ

- Solid quartz
- Bevel ($\pm 1/4$ ")/Straight Polish profile edge top
- Applied Straight Polish edge backsplash and endsplash

Series/Core Code:

QS01S Solid

QS01S available countertop thicknesses:

- 20mm / 2cm (3/4")
- 30mm / 3cm (1-3/16")

QT = Quartz Top
QB = Quartz Backsplash
QE = Quartz Endsplash

QS02

Example:
QS02S2020

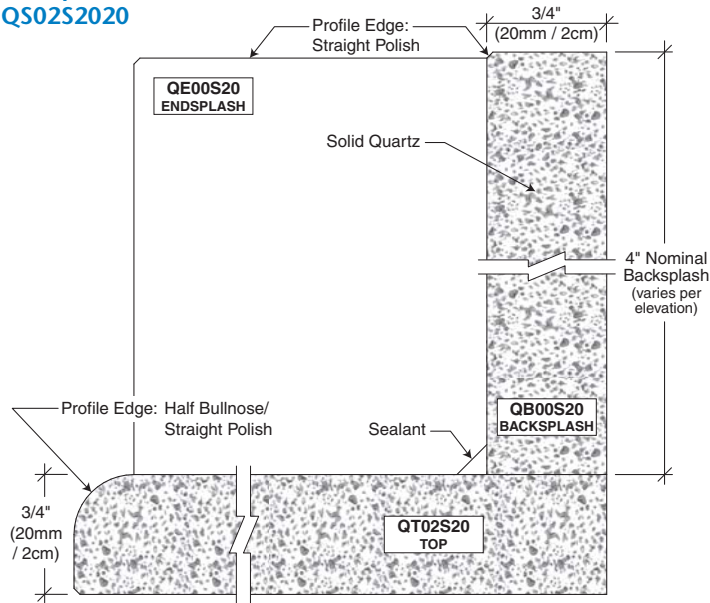

QS02 QUARTZ

- Solid quartz
- Half Bullnose/Straight Polish profile edge top
- Applied Straight Polish profile edge backsplash and endsplash

Series/Core Code:

QS02S Solid

QS02S available countertop thicknesses:

- 20mm / 2cm (3/4")
- 30mm / 3cm (1-3/16")

WINDOWSILLS

Laminate Series

LT = Laminate Top



LS50

Example:
LS50C27

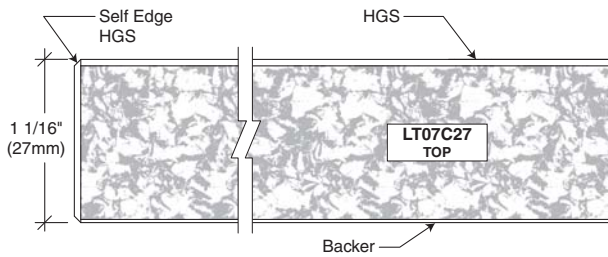

LS50 LAMINATE WINDOWSILL

- Self edge

Series/Core Codes:

- LS50C** TSCA particleboard
- LS50M** Moisture-resistant/NAF particleboard
- LS50F** Fire-rated particleboard
- LS50D** Medium Density Fiberboard (MDF)
- LS50G** Moisture-resistant/NAF MDF
- LS50H** Fire-rated MDF
- LS50P** Plywood

LS50C, LS50M, LS50F, LS50D, LS50G and LS50H available windowsill thicknesses:

- 21mm (13/16")
- 27mm (1-1/16")
- 30mm (1-3/16") (n/a for LS50F fire-rated particleboard)
- 40mm (1-9/16") (n/a for LS50H fire-rated MDF)

LS50P available windowsill thicknesses:

- 20mm (3/4")
- 27mm (1-1/16")
- 40mm (1-9/16")

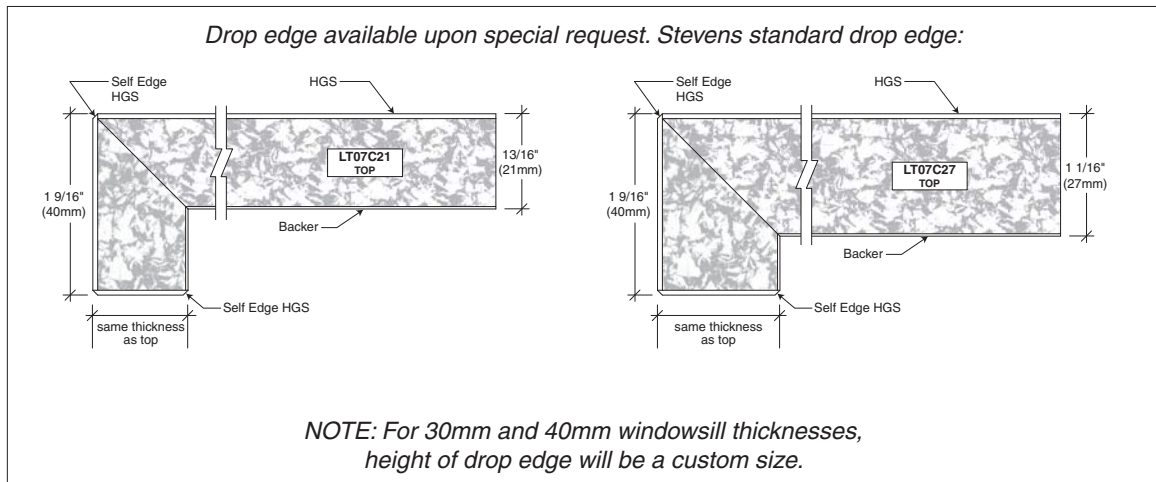

LT = Laminate Top

LS51

Example:
LS51C27

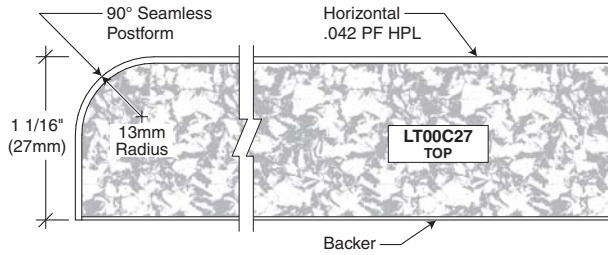

LS51 LAMINATE WINDOWSILL

- 90° postform edge

Series/Core Codes:

- LS51C** TSCA particleboard
- LS51M** Moisture-resistant/NAF particleboard
- LS51F** Fire-rated particleboard
- LS51D** Medium Density Fiberboard (MDF)
- LS51G** Moisture-resistant/NAF MDF
- LS51H** Fire-rated MDF

LS51C, LS51M, LS51F, LS51D, LS51G and LS51H available windowsill thicknesses:

- 21mm (13/16")
- 27mm (1-1/16")
- 30mm (1-3/16") (n/a for LS51F fire-rated particleboard)
- 40mm (1-9/16") (n/a for LS51H fire-rated MDF)

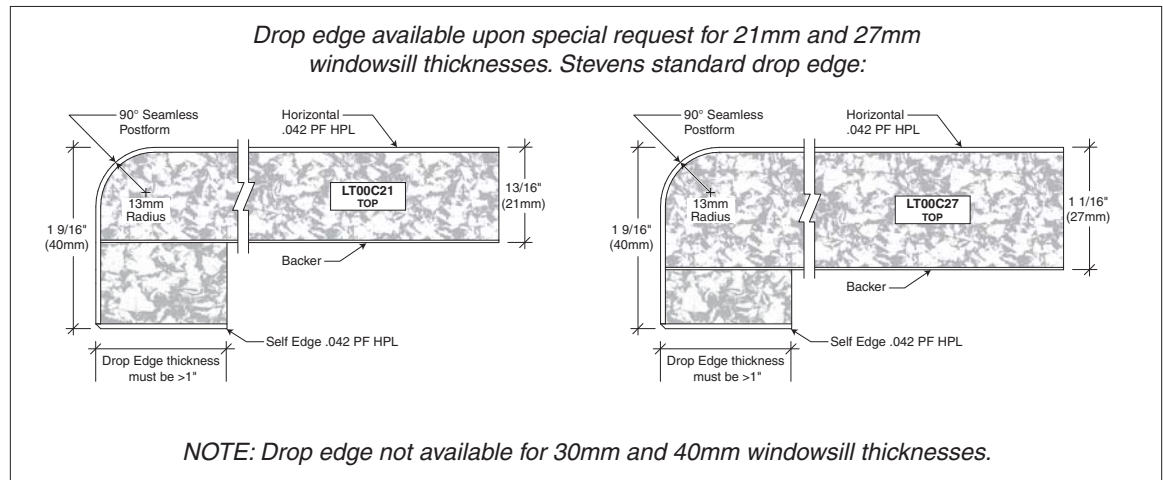

WINDOWSILLS

Laminate Series

LT = Laminate Top



LS52

Example:
LS52C27

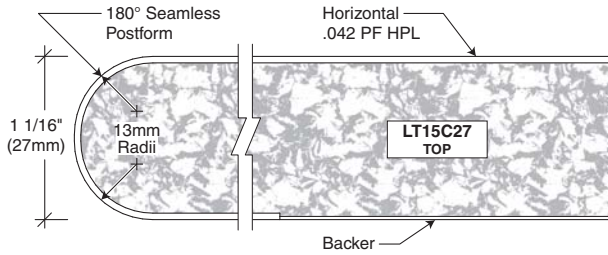

LS52 LAMINATE WINDOWSILL

- 180° postform edge

Series/Core Codes:

- LS52C** TSCA particleboard
- LS52M** Moisture-resistant/NAF particleboard
- LS52F** Fire-rated particleboard
- LS52D** Medium Density Fiberboard (MDF)
- LS52G** Moisture-resistant/NAF MDF
- LS52H** Fire-rated MDF

LS52C, LS52M, LS52F, LS52D, LS52G and LS52H available windowsill thicknesses:
 27mm (1-1/16")
 30mm (1-3/16") (n/a for LS52F fire-rated particleboard)
 40mm (1-9/16") (n/a for LS52H fire-rated MDF)

*Drop edge available upon special request for 27mm windowsill thickness.
 Stevens standard drop edge:*

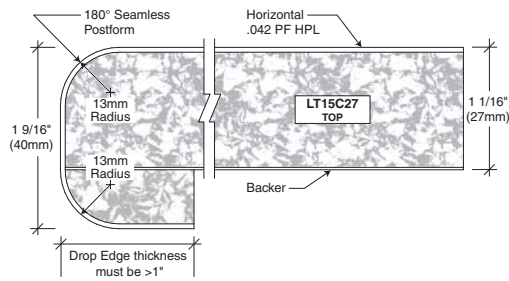

NOTE: Drop edge not available for 30mm and 40mm windowsill thicknesses.

PT = Solid Surface Top

PS10

Example:
PS10S12

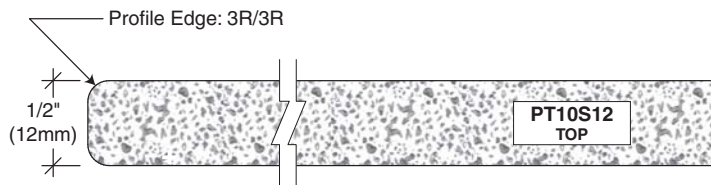

PS10 SOLID SURFACE WINDOWSILL

- Solid surface (polymer) materials
- 3R/3R profile edge

Series/Core Code:

PS10S Solid

PS10S available thickness:
12mm (1/2")

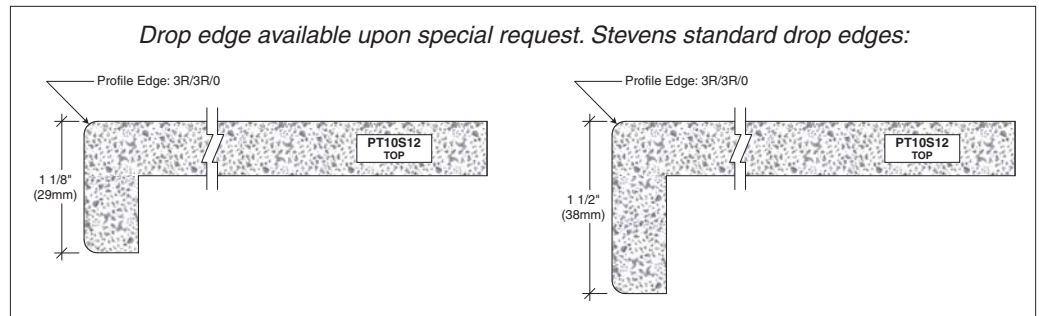

PS11

Example:
PS11S12

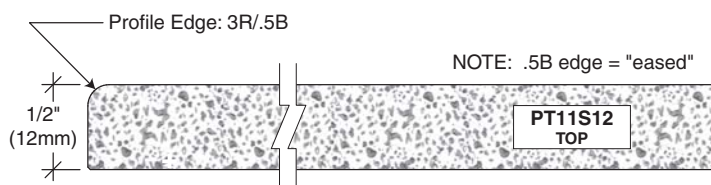

PS11 SOLID SURFACE WINDOWSILL

- Solid surface (polymer) materials
- 3R/.5B profile edge

Series/Core Code:

PS11S Solid

PS11S available thickness:
12mm (1/2")

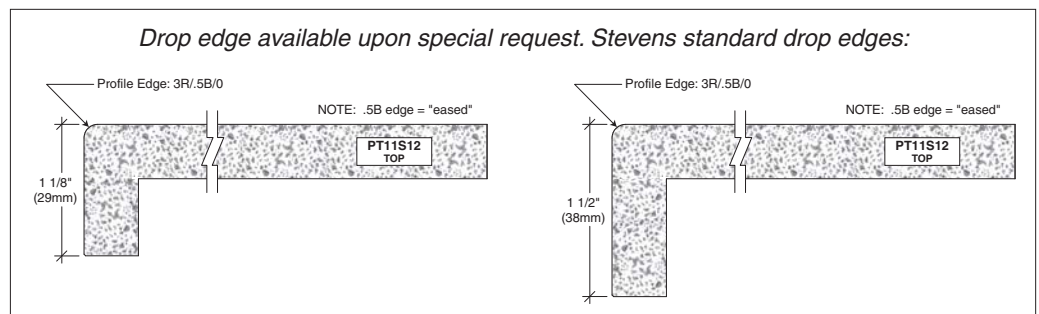

WINDOWSILLS

Solid Surface Series

PT = Solid Surface Top



PS12

Example:
PS12S12

PS12 SOLID SURFACE WINDOWSILL

- Solid surface (polymer) materials
- 6R/6R profile edge

Series/Core Code:

PS12S Solid

PS12S available thickness:
12mm (1/2")

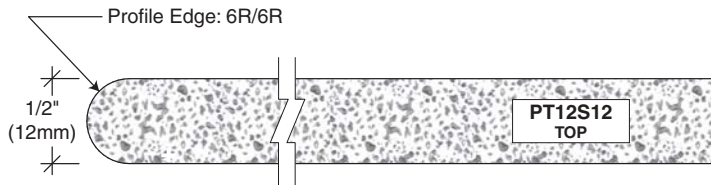

PS13

Example:
PS13S12

PS13 SOLID SURFACE WINDOWSILL

- Solid surface (polymer) materials
- .5B/.5B profile edge

Series/Core Code:

PS13S Solid

PS13S available thickness:
12mm (1/2")

