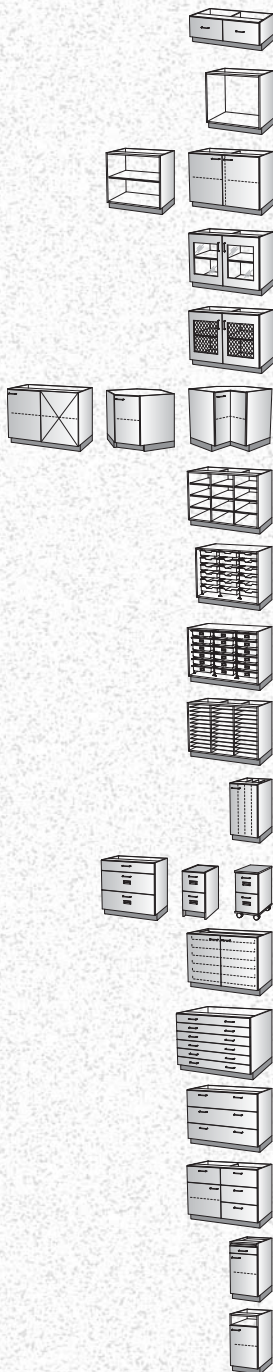

Table of Contents

BASE



Bench	3
Open	4
Shelf	4-5
Display	6
Expanded Metal Door	7
Corner	8-9
Cubicle	10-11
Bin Storage	12
Tray Storage	13-15
Folder	16
Vertical Storage	17
File Drawer	18-20
Rollout Shelf	21
Paper Storage	22
Drawer	23-28
Combination Storage	29-35
Pull Board	36
Book Box	37

(continued on page 2)

Table of Contents *(continued)*

BASE

Open Bottom.....	38
Media Integration	39
Memo Desk.....	40
Sink Base.....	41-42
Wall Sink	42
ADA Sink Base	43-44
ADA Wall Sink.....	45-47
Steel Frame Wall Vanity	48-51
Vanity Wall Closure	52
Trash/Cart Storage.....	53-55
Specialty.....	56
Half-Depth Shelf.....	57-59
Installation Accessories	60-63
Design Details.....	64

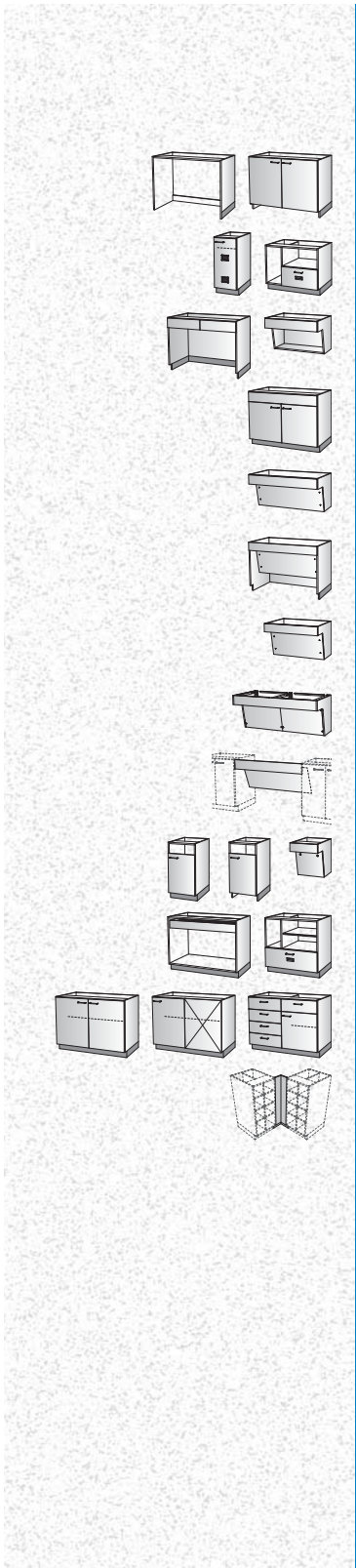

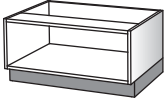
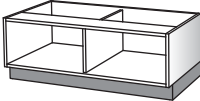
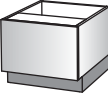
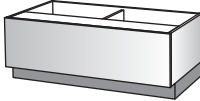
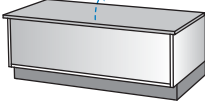
Bench					
	<p>W: 18,21,24,27,30,33,36 H: 17 D: 14,18,24</p> <p>Open Compartment Requires Min. 3/4" Overlay Top (not included)</p>	<p>W: 39,42,45,48 H: 17 D: 14,18,24</p> <p>Open Compartments Center Divider Requires Min. 3/4" Overlay Top (not included)</p>	<p>W: 15,18,21 H: 17 D: 14,18,24</p> <p>Solid Front Panel No Storage Requires Min. 3/4" Overlay Top (not included)</p>	<p>W: 24,27,30,33,36,39, 42,45,48 H: 17 D: 14,18,24</p> <p>Solid Front Panel Center Divider No Storage Requires Min. 3/4" Overlay Top (not included)</p>	<p>W: 30,33,36,39,42,45,48 H: 17 D: 21,24</p> <p>Lid with Lift Assist Mechanism and Continuous Hinge Internal Storage Compartment 18 1/8" Overall Height</p>
	10080	10081	10089	10088	10090
17H					

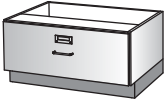
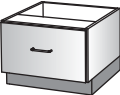
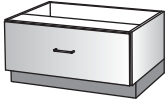
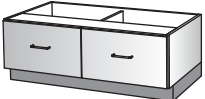
Bench					
	<p>W: 15,18 H: 17 D: 21,24</p> <p>Full Extension File Drawer 15W=Letter 18W=Legal Requires Min. 3/4" Overlay Top (not included)</p>	<p>W: 30,36 H: 17 D: 21,24</p> <p>Full Extension Lateral File Drawer with Divider for Side Filing of Letter/ Legal Files Requires Min. 3/4" Overlay Top (not included)</p>	<p>W: 15,18,21,24 H: 17 D: 18,21,24</p> <p>Deep Drawer Requires Min. 3/4" Overlay Top (not included)</p>	<p>W: 27,30,33,36 H: 17 D: 18,21,24</p> <p>Deep Drawer Requires Min. 3/4" Overlay Top (not included)</p>	<p>W: 30,33,36,39,42,45,48 H: 17 D: 18,21,24</p> <p>2 Deep Drawers Requires Min. 3/4" Overlay Top (not included)</p>
	10082	10083	10084	10085	10086
17H					

BASE

Open / Shelf

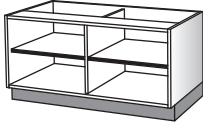
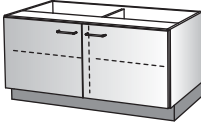
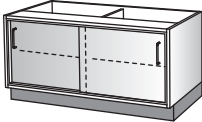
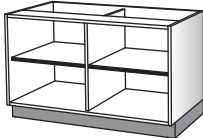
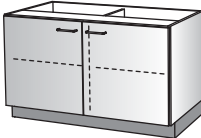
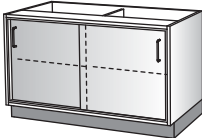
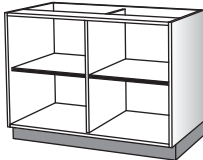
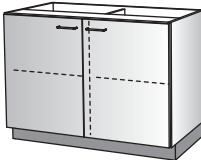
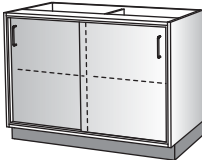
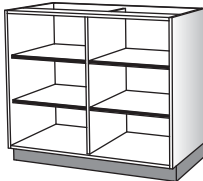
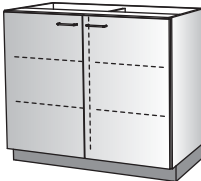
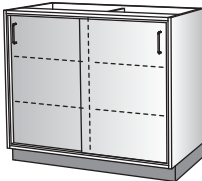

	Open	Shelf			
	<p>W: 12,15,18,21,24,27,30,33,36,39,42,45,48 H: 24,29,32,35,41 D: 14,18,21,24,29</p> <p>Optional Removable Back</p>	<p>W: 12,15,18,21,24,27,30,33,36,39,42,45,48 H: 24,29,32,35,41 D: 14,18,21,24,29</p> <p>Adjustable Shelves Optional Removable Back</p>	<p>W: 12,15,18,21,24 H: 24,29,32,35,41 D: 14,18,21,24,29</p> <p>Right Hinge Door Adjustable Shelves Optional Removable Back</p>	<p>W: 12,15,18,21,24 H: 24,29,32,35,41 D: 14,18,21,24,29</p> <p>Left Hinge Door Adjustable Shelves Optional Removable Back</p>	<p>W: 24,27,30,33,36,39,42,45,48 H: 24,29,32,35,41 D: 14,18,21,24,29</p> <p>Doors Adjustable Shelves Optional Removable Back</p>
	10100	10101	10120	10121	10129
24H					
29H					
32H 35H					
41H					

Shelf				
	<p>W: 39,42,45,48 H: 24,29,32,35,41 D: 14,18,21,24,29</p> <p>Center Divider Adjustable Shelves</p>	<p>W: 30,33,36,39,42,45,48 H: 24,29,32,35,41 D: 14,18,21,24,29</p> <p>Doors Center Divider Adjustable Shelves</p>	<p>W: 30,33,36,39,42,45,48 H: 24,29,32,35,41 D: 18,21,24,29</p> <p>Sliding Doors Center Divider Adjustable Shelves</p>	
	10138	10181	10150	
24H				
29H				
32H 35H				
41H				

BASE

Display



Display

W: 15,18,21,24
H: 29,32,35,41
D: 14,18,21,24,29

Right Hinge Display Door
Adjustable Shelves

W: 15,18,21,24
H: 29,32,35,41
D: 14,18,21,24,29

Left Hinge Display Door
Adjustable Shelves

W: 30,36
H: 29,32,35,41
D: 14,18,21,24,29

Display Doors
Adjustable Shelves

W: 30,36,42,48
H: 29,32,35,41
D: 14,18,21,24,29

Display Doors
Center Divider
Adjustable Shelves

10102

10103

10104

10105

29H

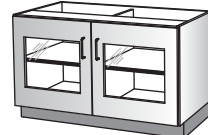
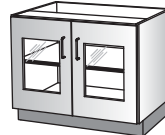



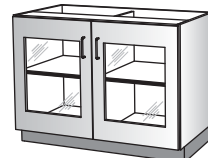
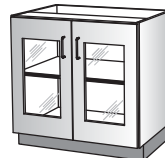

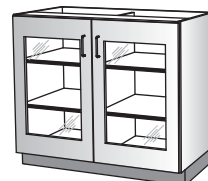

32H
35H

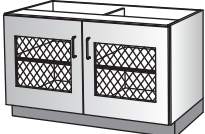

41H

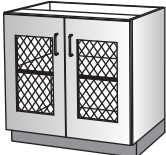
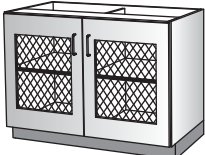

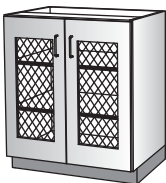
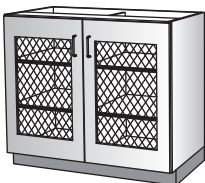
Expanded Metal Door				
	<p>W: 15,18,21,24 H: 29,32,35,41 D: 14,18,21,24,29</p> <p>Right Hinge Framed Expanded Metal Door Adjustable Shelves Expanded Metal Available in Black, White, Grey (color linked to accent color option)</p>	<p>W: 15,18,21,24 H: 29,32,35,41 D: 14,18,21,24,29</p> <p>Left Hinge Framed Expanded Metal Door Adjustable Shelves Expanded Metal Available in Black, White, Grey (color linked to accent color option)</p>	<p>W: 30,36 H: 29,32,35,41 D: 14,18,21,24,29</p> <p>Framed Expanded Metal Doors Adjustable Shelves Expanded Metal Available in Black, White, Grey (color linked to accent color option)</p>	<p>W: 30,36,42,48 H: 29,32,35,41 D: 14,18,21,24,29</p> <p>Framed Expanded Metal Doors Center Divider Adjustable Shelves Expanded Metal Available in Black, White, Grey (color linked to accent color option)</p>
	10106	10107	10108	10109
29H				
32H 35H				
41H				

BASE

Corner

6 1/8" H top drawer fronts align with other noted 6 1/8" H drawer and false fronts.



Corner – Blind

14" DEEP:
W: 33,36
H: 29,32,35,41
D: 14

18" DEEP:
W: 36,39
H: 29,32,35,41
D: 18

21" DEEP:
W: 36,39,42
H: 29,32,35,41
D: 21

24" DEEP:
W: 42,45,48
H: 29,32,35,41
D: 24

Right Hinge Door
 Adjustable Shelf

14" DEEP:
W: 33,36
H: 29,32,35,41
D: 14

18" DEEP:
W: 36,39
H: 29,32,35,41
D: 18

21" DEEP:
W: 36,39,42
H: 29,32,35,41
D: 21

24" DEEP:
W: 42,45,48
H: 29,32,35,41
D: 24

Left Hinge Door
 Adjustable Shelf

18" DEEP:
W: 36,39
H: 29,32,35,41
D: 18

21" DEEP:
W: 36,39,42
H: 29,32,35,41
D: 21

24" DEEP:
W: 42,45,48
H: 29,32,35,41
D: 24

Drawer: 6 1/8" H Front
 Right Hinge Door
 Adjustable Shelf

18" DEEP:
W: 36,39
H: 29,32,35,41
D: 18

21" DEEP:
W: 36,39,42
H: 29,32,35,41
D: 21

24" DEEP:
W: 42,45,48
H: 29,32,35,41
D: 24

Drawer: 6 1/8" H Front
 Left Hinge Door
 Adjustable Shelf

10200

10201

10205

10206

29H

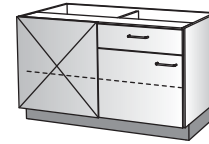
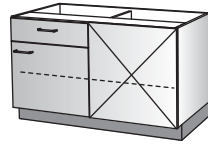
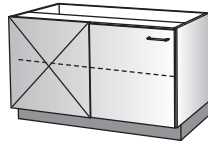
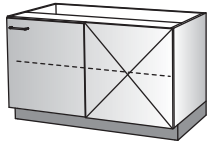



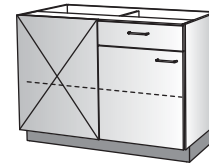
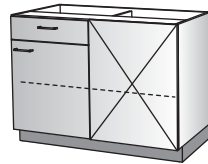
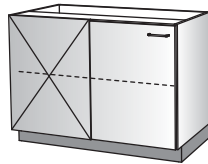
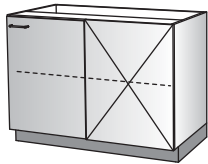

32H
35H

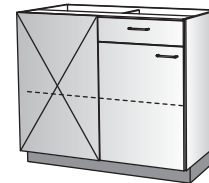
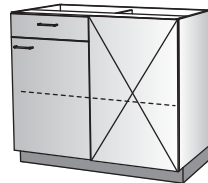
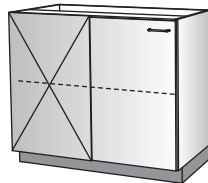
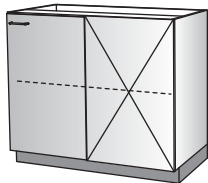

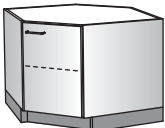
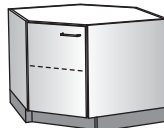
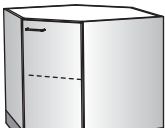
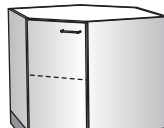
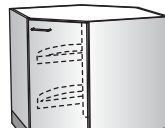
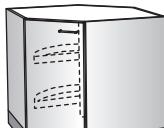
41H

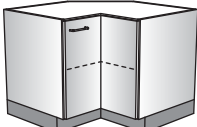

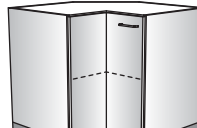
Corner – Diagonal				
	<p>W: 30 H: 29,32,35,41 D: 21,24</p> <p>Right Hinge Door Fixed Shelf</p>	<p>W: 30 H: 29,32,35,41 D: 21,24</p> <p>Left Hinge Door Fixed Shelf</p>		<p>W: 30 H: 32,35 D: 21,24</p> <p>Right Hinge Door 2 Lazy Susans</p>
				<p>W: 30 H: 32,35 D: 21,24</p> <p>Left Hinge Door 2 Lazy Susans</p>
	10211	10212	10213	10214
29H				
32H 35H 41H			32H 35H	
				

Corner – L-Shaped				
	<p>W: 30 H: 29,32,35,41 D: 21,24</p> <p>Right Hinge Folding Door Fixed Shelf</p>	<p>W: 30 H: 29,32,35,41 D: 21,24</p> <p>Left Hinge Folding Door Fixed Shelf</p>		<p>W: 30 H: 32,35 D: 21,24</p> <p>Right Hinge Folding Door 2 Lazy Susans</p>
				<p>W: 30 H: 32,35 D: 21,24</p> <p>Left Hinge Folding Door 2 Lazy Susans</p>
	10215	10216	10217	10218
29H				
32H 35H 41H			32H 35H	
				

BASE

Cubicle

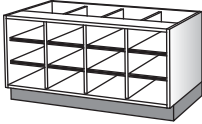
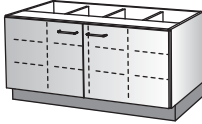
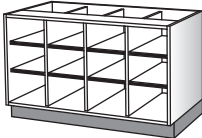
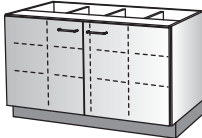
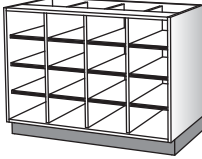
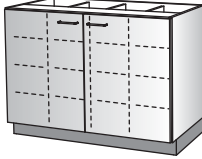
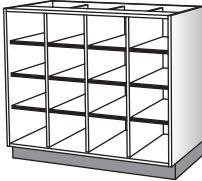
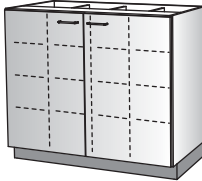

Cubicle							
Compt. Widths 18W = 7 7/8" 24W = 10 7/8"	W: 18,24 H: 24,29,32,35,41 D: 14,18,21,24,29 3/4" Adjustable Cubicle Shelves Compartment Spacing 3"H min.	W: 18,24 H: 24,29,32,35,41 D: 14,18,21,24,29 Right Hinge Door 3/4" Adjustable Cubicle Shelves Compartment Spacing 3"H min.	W: 18,24 H: 24,29,32,35,41 D: 14,18,21,24,29 Left Hinge Door 3/4" Adjustable Cubicle Shelves Compartment Spacing 3"H min.	Compt. Widths 30W = 9" 36W = 11" 42W = 13" 48W = 15"	W: 30,36,42,48 H: 24,29,32,35,41 D: 14,18,21,24,29 3/4" Adjustable Cubicle Shelves Compartment Spacing 3"H min.	W: 30,36,42,48 H: 24,29,32,35,41 D: 14,18,21,24,29 Doors 3/4" Adjustable Cubicle Shelves Compartment Spacing 3"H min.	
	10220	10222	10223		10226	10227	
	24H 6 Compts.						
	29H 6 Compts.						
	32H 35H 8 Compts.						
41H 8 Compts.							

Cubicle	
<p>Compt. Widths 36W = 8" 42W = 9½" 48W = 11"</p>	<p>W: 36,42,48 H: 24,29,32,35,41 D: 14,18,21,24,29</p> <p>¾" Adjustable Cubicle Shelves Compartment Spacing 3"H min.</p>
	<p>W: 36,42,48 H: 24,29,32,35,41 D: 14,18,21,24,29</p> <p>Doors ¾" Adjustable Cubicle Shelves Compartment Spacing 3"H min.</p>
	<p>10239 10240</p>
<p>24H 12 Compts.</p>	 
<p>29H 12 Compts.</p>	 
<p>32H 35H 16 Compts.</p>	 
<p>41H 16 Compts.</p>	 

BASE

Bin Storage



SA910: 12¹/₄W x 3H x 16³/₄D



SA911: 12¹/₄W x 6H x 16³/₄D

Bin Storage

W: 42
H: 24,29,32,35,41
D: 21,24

Molded Translucent Bins

W: 42
H: 24,29,32,35,41
D: 21,24

Doors
Molded Translucent Bins

W: 42
H: 24,29,32,35,41
D: 21,24

Molded Translucent Bins

W: 42
H: 24,29,32,35,41
D: 21,24

Doors
Molded Translucent Bins

10242

10243

10244

10245

24H
(12) SA910
Bins

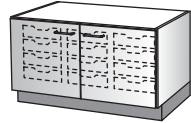
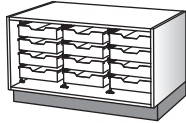

24H
(6) SA911
Bins

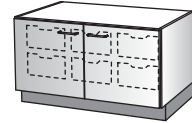
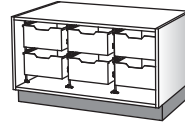

29H
32H
(15) SA910
Bins

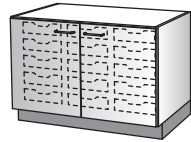
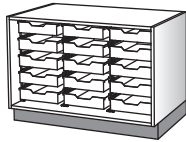

29H
32H
(3) SA910
Bins
(6) SA911
Bins

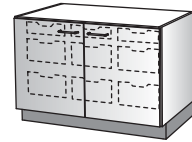
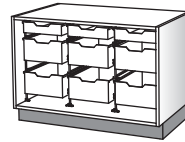

35H
(18) SA910
Bins

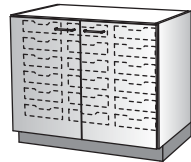
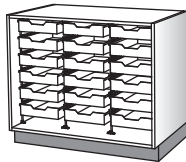

35H
(9) SA911
Bins

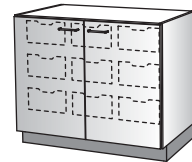
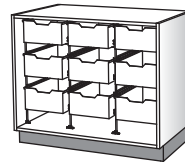

41H
(21) SA910
Bins

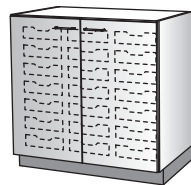
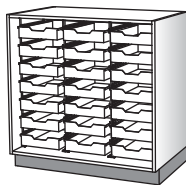



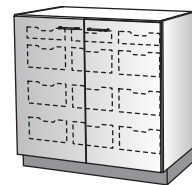
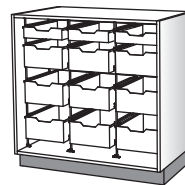







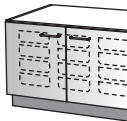

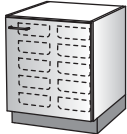
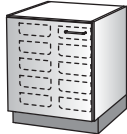
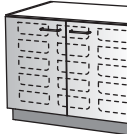

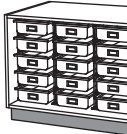
41H
(3) SA910
Bins
(9) SA911
Bins

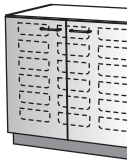

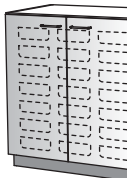

SA902: 10W x 3 1/2H x 19D

Tray Storage		Tray Storage		Tray Storage	
W: 24 H: 24,29,32,35,41 D: 24	W: 24 H: 24,29,32,35,41 D: 24	W: 24 H: 24,29,32,35,41 D: 24		W: 36 H: 24,29,32,35,41 D: 24	W: 36 H: 24,29,32,35,41 D: 24
Molded Trays with Card Holder	Right Hinge Door Molded Trays with Card Holder	Left Hinge Door Molded Trays with Card Holder		Molded Trays with Card Holder	Doors Molded Trays with Card Holder
10263	10264	10265		10270	10271
24H (8) SA902 Trays				24H (12) SA902 Trays	
					
29H 32H (10) SA902 Trays				29H 32H (15) SA902 Trays	
					
35H (12) SA902 Trays				35H (18) SA902 Trays	
					
41H (14) SA902 Trays				41H (21) SA902 Trays	
					

BASE

Tray Storage



SA901: 14 1/4W x 3 1/2H x 19D



SA902: 10W x 3 1/2H x 19D

Tray Storage

W: 48
H: 24,29,32,35,41
D: 24

Molded Trays with Card Holder

W: 48
H: 24,29,32,35,41
D: 24

Doors
Molded Trays with Card Holder

W: 48
H: 24,29,32,35,41
D: 24

Molded Trays with Card Holder

W: 48
H: 24,29,32,35,41
D: 24

Doors
Molded Trays with Card Holder

10274

10275

10281

10282

24H
(12) SA901
Trays

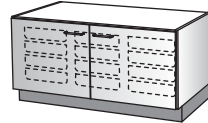
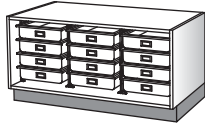

24H
(16) SA902
Trays

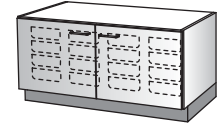
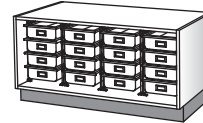

29H
32H
(15) SA901
Trays

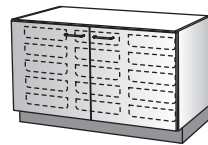

29H
32H
(20) SA902
Trays

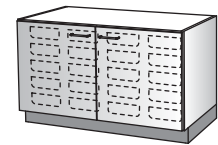
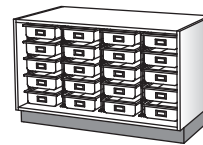

35H
(18) SA901
Trays

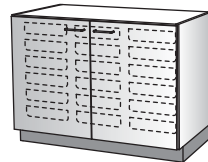
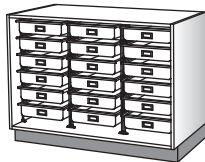

35H
(24) SA902
Trays

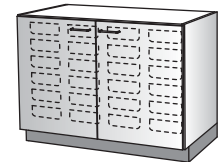
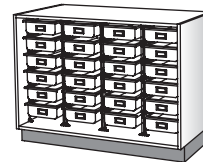

41H
(21) SA901
Trays

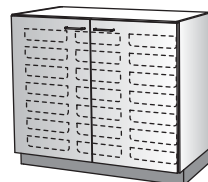
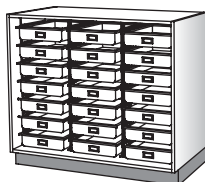

41H
(28) SA902
Trays

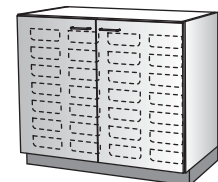
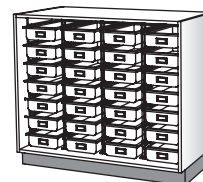

Tray Storage



SA901: 14 1/4W x 3 1/2H x 19D

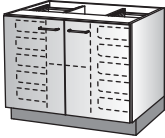
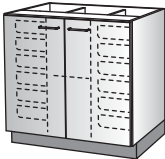
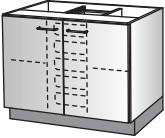
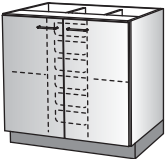

SA902: 10W x 3 1/2H x 19D

Tray Storage	
<p>W: 36 H: 29,32,35 D: 24</p> <p>Doors Molded Trays with Card Holder Adjustable Shelf</p>	<p>W: 36 H: 29,32,35 D: 24</p> <p>Doors Molded Trays with Card Holder Adjustable Shelves</p>
<p>10283</p> <p>29H 32H (10) SA902 Trays</p>  <p>35H (12) SA902 Trays</p> 	<p>10284</p> <p>29H 32H (5) SA902 Trays</p>  <p>35H (6) SA902 Trays</p> 

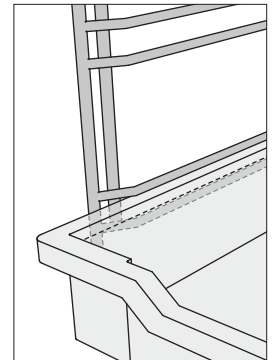

Bin and tray racks have captured runner rail to reduce tray tipout.

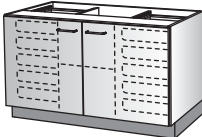
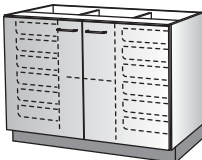
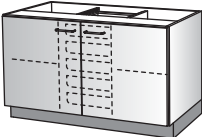
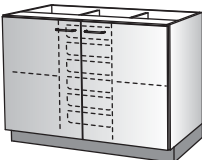
Tray Storage	
<p>W: 48 H: 29,32,35 D: 24</p> <p>Doors Molded Trays with Card Holder Adjustable Shelf</p>	<p>W: 48 H: 29,32,35 D: 24</p> <p>Doors Molded Trays with Card Holder Adjustable Shelves</p>
<p>10285</p> <p>29H 32H (10) SA901 Trays</p>  <p>35H (12) SA901 Trays</p> 	<p>10286</p> <p>29H 32H (5) SA901 Trays</p>  <p>35H (6) SA901 Trays</p> 

BASE

Folder





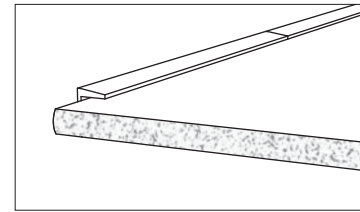



Folder			
Compt. Widths 15W = 13 1/2" 18W = 16 1/2" 21W = 19 1/2" 24W = 22 1/2"	W: 15,18,21,24 H: 29,32,35 D: 18,21,24 1/4" Folder Shelves, Adjustable and Removable on 1 1/4" Centers	W: 15,18,21,24 H: 29,32,35 D: 18,21,24 Right Hinge Door 1/4" Folder Shelves, Adjustable and Removable on 1 1/4" Centers	W: 15,18,21,24 H: 29,32,35 D: 18,21,24 Left Hinge Door 1/4" Folder Shelves, Adjustable and Removable on 1 1/4" Centers
	10641	10642	10643
29H 9 Compts. 2 1/4"H min.			
	32H 35H 12 Compts. 2 1/4"H min.		



1/4"-thick folder shelves are held securely with translucent, low profile shelf supports.

All edges unfinished.
Front edge unfinished and shaped.

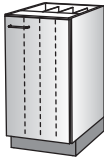
Folder					
Compt. Widths 30W = 13 7/8" 36W = 16 7/8" 42W = 19 7/8" 48W = 22 7/8"	W: 30,36,42,48 H: 29,32,35 D: 18,21,24 1/4" Folder Shelves, Adjustable and Removable on 1 1/4" Centers	W: 30,36,42,48 H: 29,32,35 D: 18,21,24 Doors 1/4" Folder Shelves, Adjustable and Removable on 1 1/4" Centers	Compt. Widths 30W = 9" 36W = 11" 42W = 13" 48W = 15"	W: 30,36,42,48 H: 29,32,35 D: 18,21,24 1/4" Folder Shelves, Adjustable and Removable on 1 1/4" Centers	W: 30,36,42,48 H: 29,32,35 D: 18,21,24 Doors 1/4" Folder Shelves, Adjustable and Removable on 1 1/4" Centers
	10645	10646		10647	10648
29H 18 Compts. 2 1/4"H min.			29H 27 Compts. 2 1/4"H min.		
	32H 35H 24 Compts. 2 1/4"H min.				32H 35H 36 Compts. 2 1/4"H min.

Vertical Storage				
Number of Compts. 15W = 4 18W = 4 21W = 5 24W = 5	W: 15,18,21,24 H: 32,35 D: 18,21,24,29 Drawer: 6 1/8" H Front Right Hinge Door 1/4" Adjustable and Removable Vertical Dividers	W: 15,18,21,24 H: 32,35 D: 18,21,24,29 Drawer: 6 1/8" H Front Left Hinge Door 1/4" Adjustable and Removable Vertical Dividers	W: 15,18,21,24 H: 29,32,35 D: 18,21,24,29 Right Hinge Door 1/4" Adjustable and Removable Vertical Dividers	W: 15,18,21,24 H: 29,32,35 D: 18,21,24,29 Left Hinge Door 1/4" Adjustable and Removable Vertical Dividers
	10659	10658	10665	10666
29H				
32H 35H				

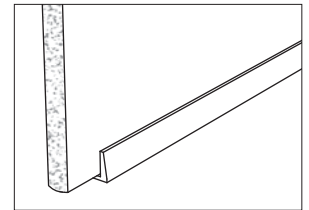

1/4"-thick vertical dividers are held securely with translucent, low profile supports.

All edges unfinished.
Front edge unfinished and shaped.

BASE

File Drawer

File drawer units align with 2-, 3-, and 4-drawer tall file units.
File units must be securely anchored.













File Drawer				
	<p>W: 15,18 H: 29,32,35 D: 18,21,24,29</p> <p>Open Compartment Full Extension File Drawer 15W: Letter File Drawer 18W: Legal File Drawer</p>	<p>W: 24,27,30,33,36,39,42 H: 29,32,35 D: 21,24</p> <p>Open Compartment Full Extension Lateral File Drawer with Divider for Side Filing of Letter/Legal Files Drawer Box Depth=440mm</p>	<p>W: 15,18 H: 29,32,35 D: 18,21,24,29</p> <p>2 Full Extension File Drawers 15W: Letter File Drawers 18W: Legal File Drawers 32H and 35H have Non-Standard Drawer Front Heights</p>	<p>W: 24,27,30,33,36,39,42 H: 29,32,35 D: 21,24</p> <p>2 Full Extension Lateral File Drawers with Divider for Side Filing of Letter/Legal Files Drawer Box Depth=440mm 32H and 35H have Non-Standard Drawer Front Heights</p>
	10330	10331	10316	10318
<p>29H 32H 35H</p>				
<p>Letter and legal file drawers are designed for front-to-back filing. Optional crossbars allow side filing. Lateral file drawers are designed for side filing. Optional file bars allow front-to-back filing. See Installation Accessories.</p>				

File Drawer				
	<p>W: 15,18 H: 29,32,35 D: 18,21,24,29</p> <p>2 Equal Drawers Full Extension File Drawer (no label holder) 15W: Letter File Drawer 18W: Legal File Drawer</p>	<p>W: 15,18 H: 29,32,35 D: 18,21,24,29</p> <p>2 Equal Drawers Full Extension File Drawer 15W: Letter File Drawer 18W: Legal File Drawer</p>	<p>W: 24,27,30,33,36,39,42 H: 29,32,35 D: 21,24</p> <p>2 Equal Drawers Full Extension Lateral File Drawer with Divider for Side Filing of Letter/Legal Files Drawer Box Depth = 440mm</p>	<p>W: 15,18 H: 29,32,35 D: 18,21,24,29</p> <p>Pull Board Drawer Full Extension File Drawer 15W: Letter File Drawer 18W: Legal File Drawer</p>
	10313	10329	10314	10322
<p>29H 32H 35H</p>				

File Drawer

File drawer units align with 2-, 3-, and 4-drawer tall file units.
File units must be securely anchored.

File Drawer					
	<p>W: 15,18 H: 32,35 D: 18,21,24,29</p> <p>Drawer 2 Full Extension File Drawers 15W: Letter File Drawers 18W: Legal File Drawers</p>	<p>W: 24,27,30,33,36,39,42 H: 32,35 D: 21,24</p> <p>Drawer 2 Full Extension Lateral File Drawers with Divider for Side Filing of Letter/Legal Files Drawer Box Depth=440mm</p>	<p>W: 15,18 H: 35 D: 18,21,24,29</p> <p>Pull Board Drawer 2 Full Extension File Drawers 15W: Letter File Drawers 18W: Legal File Drawers</p>	<p>W: 15,18 H: 32,35 D: 18,21,24,29</p> <p>3 Drawers Full Extension File Drawer 15W: Letter File Drawer 18W: Legal File Drawer</p>	<p>W: 24,27,30,33,36,39,42 H: 32,35 D: 21,24</p> <p>3 Drawers Full Extension Lateral File Drawer with Divider for Side Filing of Letter/Legal Files Drawer Box Depth=440mm</p>
	10317	10319	10327	10320	10321
32H 35H					
<p>Letter and legal file drawers are designed for front-to-back filing. Optional crossbars allow side filing. Lateral file drawers are designed for side filing. Optional file bars allow front-to-back filing. See Installation Accessories.</p>					

File Drawer						
	<p>W: 15,18 H: 41 D: 18,21,24,29</p> <p>3 Full Extension File Drawers 15W: Letter File Drawers 18W: Legal File Drawers</p>	<p>W: 24,27,30,33,36,39,42 H: 41 D: 21,24</p> <p>3 Full Extension Lateral File Drawers with Divider for Side Filing of Letter/Legal Files Drawer Box Depth=440mm</p>	<p>W: 15,18 H: 41 D: 18,21,24,29</p> <p>Pull Board Drawer 2 Full Extension File Drawers 15W: Letter File Drawers 18W: Legal File Drawers</p>		<p>W: 15,18 H: 54 D: 18,21,24,29</p> <p>4 Full Extension File Drawers Finished Top 15W: Letter File Drawers 18W: Legal File Drawers</p>	<p>W: 24,27,30,33,36,39,42 H: 54 D: 21,24</p> <p>4 Full Extension Lateral File Drawers with Divider for Side Filing of Letter/Legal Files Finished Top Drawer Box Depth=440mm</p>
	10323	10325	10328	10324	10326	
41H						
54H						

BASE

File Drawer



File Drawer – Mobile Pedestal

W: 15,18
H: 29
D: 20,23

2 Full Extension File Drawers
Finished Top
Casters: 2 Locking, 2 Non-Locking
For Use Under Typical 29H A.F.F.
Counters
15W: Letter File Drawers
18W: Legal File Drawers

W: 15,18
H: 29
D: 20,23

Pull Board
Drawer
Full Extension File Drawer
Finished Top
Casters: 2 Locking, 2 Non-Locking
For Use Under Typical 29H A.F.F.
Counters
15W: Letter File Drawer
18W: Legal File Drawer

W: 15,18
H: 29
D: 20,23

2 Drawers
Full Extension File Drawer
Finished Top
Casters: 2 Locking, 2 Non-Locking
For Use Under Typical 29H A.F.F.
Counters
15W: Letter File Drawer
18W: Legal File Drawer

10307



10308



10309



29H

Letter and legal file drawers are designed for front-to-back filing.
Optional crossbars allow side filing.
See Installation Accessories.

File Drawer – Freestanding Pedestal

W: 15,18
H: 29
D: 20,23

2 Full Extension File Drawers
Finished Top
For Use Under Typical 29H A.F.F.
Counters
15W: Letter File Drawers
18W: Legal File Drawers

W: 15,18
H: 29
D: 20,23

Pull Board
Drawer
Full Extension File Drawer
Finished Top
For Use Under Typical 29H A.F.F.
Counters
15W: Letter File Drawer
18W: Legal File Drawer

W: 15,18
H: 29
D: 20,23

2 Drawers
Full Extension File Drawer
Finished Top
For Use Under Typical 29H A.F.F.
Counters
15W: Letter File Drawer
18W: Legal File Drawer

10310







10311





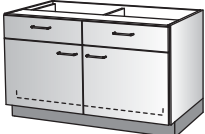

10312

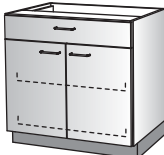
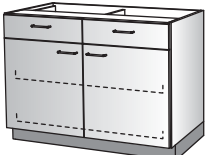

29H

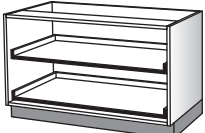
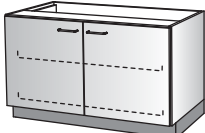
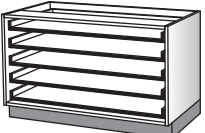
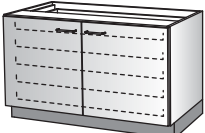
Rollout Shelf				
	<p>W: 18,21,24 H: 29,32,35 D: 24,29</p> <p>Drawer: 6½"H Front Right Hinge Door Full Extension Rollout Shelves</p>	<p>W: 18,21,24 H: 29,32,35 D: 24,29</p> <p>Drawer: 6½"H Front Left Hinge Door Full Extension Rollout Shelves</p>	<p>W: 24,27,30,33,36 H: 29,32,35 D: 24,29</p> <p>Drawer: 6½"H Front Doors Full Extension Rollout Shelves</p>	<p>W: 39,42,45,48 H: 29,32,35 D: 24,29</p> <p>Drawers: 6½"H Fronts Doors Full Extension Rollout Shelves Not for Use with Stone-Type Tops</p>
	10408	10409	10494	10495
29H				
32H 35H				

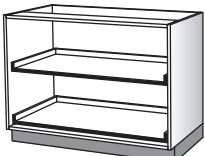
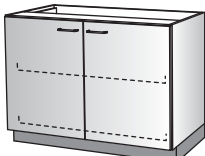
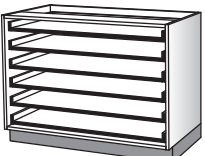
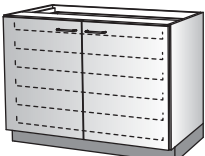
Rollout Shelf						
	<p>W: 18,21,24 H: 29,32,35 D: 24,29</p> <p>Right Hinge Door Full Extension Rollout Shelves</p>	<p>W: 18,21,24 H: 29,32,35 D: 24,29</p> <p>Left Hinge Door Full Extension Rollout Shelves</p>	<p>W: 30,33,36,39,42,45,48 H: 29,32,35 D: 24,29</p> <p>Full Extension Rollout Shelves</p>	<p>W: 30,33,36,39,42,45,48 H: 29,32,35 D: 24,29</p> <p>Doors Full Extension Rollout Shelves</p>	<p>W: 30,33,36,39,42,45,48 H: 29,32,35 D: 24,29</p> <p>Full Extension Rollout Shelves</p>	<p>W: 30,33,36,39,42,45,48 H: 29,32,35 D: 24,29</p> <p>Doors Full Extension Rollout Shelves</p>
	10490	10491	10410	10492	10411	10493
29H						
32H 35H						

BASE

Paper Storage

Paper storage drawers are equipped with ball bearing full extension type slides.
All depths may not extend full drawer depth.



Paper Storage					
	W: 48 H: 29,32,35 D: 24,29,34 5 Equal Full Extension Drawers	W: 48 H: 35 D: 24,29,34 6 Equal Full Extension Drawers	W: 48 H: 35 D: 24,29,34 7 Equal Full Extension Drawers	W: 48 H: 35 D: 24,29,34 8 Equal Full Extension Drawers	W: 48 H: 35 D: 24,29,34 Doors 6 Full Extension Rollout Shelves
	10403	10404	10405	10406	10407
29H					
32H					
35H					

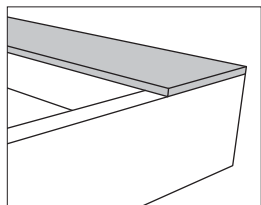

Paper storage drawers include rear retaining hoods.









Paper Storage Drawer Units

Unit Size		Paper Size	
W	D	W	D
48	24	46	20
48	29	46	24
48	34	46	28

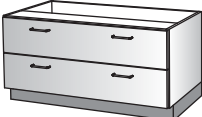
Paper Storage Rollout Shelf Units

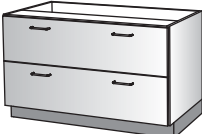
Unit Size		Paper Size	
W	D	W	D
48	24	42	19
48	29	42	24
48	34	42	30

Full-depth deep drawers provide complete access to the storage area and are ideal for ADA applications.











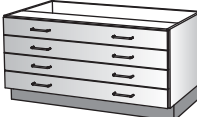
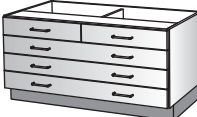
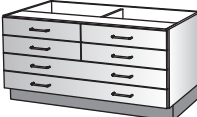





	Drawer		
	<p>W: 15,18,21,24 H: 24,29,32,35 D: 18,21,24,29</p> <p>2 Equal Drawers</p>	<p>W: 27,30,33,36 H: 24,29,32,35 D: 18,21,24,29</p> <p>2 Equal Full Extension Drawers</p>	<p>W: 39,42,45,48 H: 24,29,32,35 D: 18,21,24,29</p> <p>2 Equal Full Extension Drawers</p>
	10315	10300	10301
24H			
29H			
32H 35H			

BASE

Drawer



	Drawer				
	<p>W: 15,18,21,24,27,30,33,36</p> <p>H: 24,29,32,35,41</p> <p>D: 14,18,21,24,29</p> <p>3 Equal Drawers</p>	<p>W: 39,42,45,48</p> <p>H: 24,29,32,35,41</p> <p>D: 14,18,21,24,29</p> <p>3 Equal Drawers</p>	<p>W: 30,33,36,39,42,45,48</p> <p>H: 24,29,32,35,41</p> <p>D: 14,18,21,24,29</p> <p>Equal Drawers: 2 Half-Width 2 Full-Width</p>	<p>W: 30,33,36,39,42,45,48</p> <p>H: 24,29,32,35,41</p> <p>D: 14,18,21,24,29</p> <p>Equal Drawers: 4 Half-Width 1 Full-Width</p>	<p>W: 30,33,36,39,42,45,48</p> <p>H: 24,29,32,35,41</p> <p>D: 14,18,21,24,29</p> <p>6 Equal Drawers</p>
	10332	10334	10343	10345	10344
24H					
29H					
32H 35H					
41H					









	Drawer				
	<p>W: 15,18,21,24,27,30,33,36</p> <p>H: 24,29,32,35,41</p> <p>D: 14,18,21,24,29</p> <p>4 Equal Drawers</p>	<p>W: 39,42,45,48</p> <p>H: 24,29,32,35,41</p> <p>D: 14,18,21,24,29</p> <p>4 Equal Drawers</p>	<p>W: 30,33,36,39,42,45,48</p> <p>H: 24,29,32,35,41</p> <p>D: 14,18,21,24,29</p> <p>Equal Drawers: 2 Half-Width 3 Full-Width</p>	<p>W: 30,33,36,39,42,45,48</p> <p>H: 24,29,32,35,41</p> <p>D: 14,18,21,24,29</p> <p>Equal Drawers: 4 Half-Width 2 Full-Width</p>	<p>W: 30,33,36,39,42,45,48</p> <p>H: 24,29,32,35,41</p> <p>D: 14,18,21,24,29</p> <p>8 Equal Drawers</p>
	10370	10371	10382	10384	10769
24H					
29H					
32H 35H					
41H					

BASE

Drawer



Drawer					
	<p>W: 15,18,21,24,27,30,33,36 H: 29,32,35,41 D: 18,21,24,29</p> <p>5 Equal Drawers</p>	<p>W: 39,42,45,48 H: 29,32,35,41 D: 18,21,24,29</p> <p>5 Equal Drawers</p>	<p>W: 30,33,36,39,42,45,48 H: 29,32,35,41 D: 18,21,24,29</p> <p>Equal Drawers: 2 Half-Width 4 Full-Width</p>		<p>W: 15,18,21,24,27,30,33,36 H: 35,41 D: 18,21,24,29</p> <p>6 Equal Drawers</p>
	10392	10393	10394	10397	10398
29H					
32H 35H				35H	
41H				41H	

Drawer				
	<p>W: 15,18,21,24,27,30,33,36 H: 35,41 D: 18,21,24,29</p> <p>7 Equal Full Extension Drawers</p>	<p>W: 39,42,45,48 H: 35,41 D: 18,21,24,29</p> <p>7 Equal Full Extension Drawers</p>	<p>W: 15,18,21,24,27,30,33,36 H: 35,41 D: 18,21,24,29</p> <p>8 Equal Full Extension Drawers</p>	<p>W: 39,42,45,48 H: 35,41 D: 18,21,24,29</p> <p>8 Equal Full Extension Drawers</p>
	10399	10400	10401	10402
35H				
41H				

BASE

Drawer

6 1/8"H top drawer fronts align with other noted 6 1/8"H drawer and false fronts.









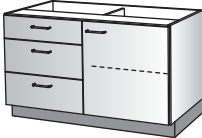
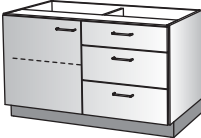

		Drawer			
		W: 15,18,21,24,27,30,33,36 H: 29,32,35 D: 14,18,21,24,29 Top Drawer: 6 1/8"H Front 2 Equal Drawers	W: 39,42,45,48 H: 29,32,35 D: 14,18,21,24,29 Top Drawer: 6 1/8"H Front 2 Equal Drawers	W: 39,42,45,48 H: 29,32,35 D: 14,18,21,24,29 Top Drawers: 6 1/8"H Fronts 2 Equal Drawers	W: 30,33,36,39,42,45,48 H: 29,32,35 D: 14,18,21,24,29 Top Drawers: 6 1/8"H Fronts 4 Equal Drawers
		10339	10340	10341	10354
29H					
32H 35H					

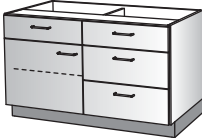
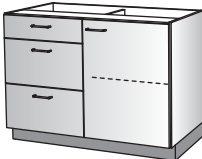
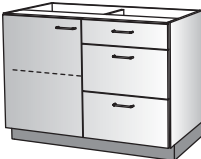
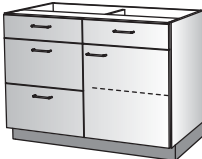
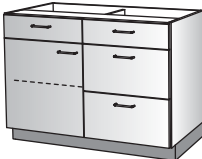
		Drawer			
		W: 15,18,21,24,27,30,33,36 H: 32,35,41 D: 14,18,21,24,29 Top Drawer: 6 1/8"H Front 3 Equal Drawers	W: 39,42,45,48 H: 32,35,41 D: 14,18,21,24,29 Top Drawer: 6 1/8"H Front 3 Equal Drawers	W: 39,42,45,48 H: 32,35,41 D: 14,18,21,24,29 Top Drawers: 6 1/8"H Fronts 3 Equal Drawers	W: 30,33,36,39,42,45,48 H: 32,35,41 D: 14,18,21,24,29 Top Drawers: 6 1/8"H Fronts 6 Equal Drawers
		10374	10375	10381	10378
32H 35H					
41H					

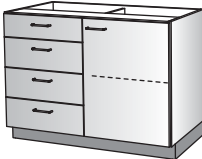
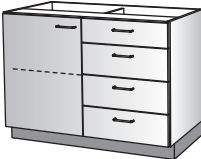
Combination Storage

6 1/8" H top drawer fronts align with other noted 6 1/8" H drawer and false fronts.

Combination Storage				
	<p>W: 30,33,36,39,42,45,48 H: 29,32,35 D: 14,18,21,24,29</p> <p>Top Drawer: 6 1/8" H Front 2 Equal Drawers Right Hinge Door Adjustable Shelf</p>	<p>W: 30,33,36,39,42,45,48 H: 29,32,35 D: 14,18,21,24,29</p> <p>Top Drawer: 6 1/8" H Front 2 Equal Drawers Left Hinge Door Adjustable Shelf</p>	<p>W: 30,33,36,39,42,45,48 H: 29,32,35 D: 14,18,21,24,29</p> <p>Top Drawers: 6 1/8" H Fronts 2 Equal Drawers Right Hinge Door Adjustable Shelf</p>	<p>W: 30,33,36,39,42,45,48 H: 29,32,35 D: 14,18,21,24,29</p> <p>Top Drawers: 6 1/8" H Fronts 2 Equal Drawers Left Hinge Door Adjustable Shelf</p>
	10358	10359	10356	10357
29H				
32H 35H				

Combination Storage				
	<p>W: 30,33,36,39,42,45,48 H: 32,35,41 D: 14,18,21,24,29</p> <p>Top Drawer: 6 1/8" H Front 3 Equal Drawers Right Hinge Door Adjustable Shelf</p>	<p>W: 30,33,36,39,42,45,48 H: 32,35,41 D: 14,18,21,24,29</p> <p>Top Drawer: 6 1/8" H Front 3 Equal Drawers Left Hinge Door Adjustable Shelf</p>	<p>W: 30,33,36,39,42,45,48 H: 32,35,41 D: 14,18,21,24,29</p> <p>Top Drawers: 6 1/8" H Fronts 3 Equal Drawers Right Hinge Door Adjustable Shelf</p>	<p>W: 30,33,36,39,42,45,48 H: 32,35,41 D: 14,18,21,24,29</p> <p>Top Drawers: 6 1/8" H Fronts 3 Equal Drawers Left Hinge Door Adjustable Shelf</p>
	10360	10361	10376	10377
32H 35H				
41H				

BASE

Combination Storage



Combination Storage

W: 30,33,36,39,42,45,48
H: 29,32,35,41
D: 14,18,21,24,29

3 Equal Drawers
 Right Hinge Door
 Adjustable Shelf

W: 30,33,36,39,42,45,48
H: 29,32,35,41
D: 14,18,21,24,29

3 Equal Drawers
 Left Hinge Door
 Adjustable Shelf

W: 30,33,36,39,42,45,48
H: 32,35,41
D: 14,18,21,24,29

4 Equal Drawers
 Right Hinge Door
 Adjustable Shelf

W: 30,33,36,39,42,45,48
H: 32,35,41
D: 14,18,21,24,29

4 Equal Drawers
 Left Hinge Door
 Adjustable Shelf

10335

10336

10757

10758

29H

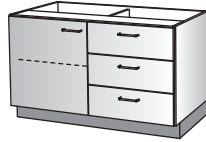
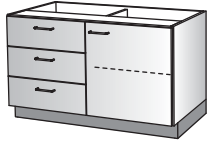



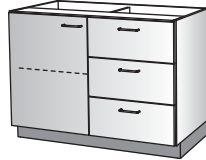
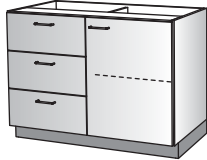



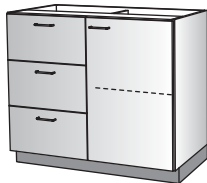

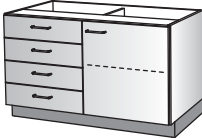
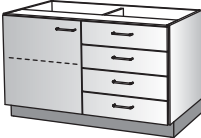

**32H
35H**

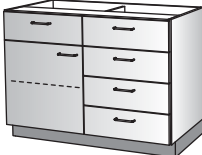

41H



Combination Storage				
	<p>W: 30,33,36,39,42,45,48 H: 29,32,35,41 D: 14,18,21,24,29</p> <p>4 Equal Drawers Right Hinge Door Adjustable Shelf</p>	<p>W: 30,33,36,39,42,45,48 H: 29,32,35,41 D: 14,18,21,24,29</p> <p>4 Equal Drawers Left Hinge Door Adjustable Shelf</p>	<p>W: 30,33,36,39,42,45,48 H: 29,32,35,41 D: 14,18,21,24,29</p> <p>5 Equal Drawers Right Hinge Door Adjustable Shelf</p>	<p>W: 30,33,36,39,42,45,48 H: 29,32,35,41 D: 14,18,21,24,29</p> <p>5 Equal Drawers Left Hinge Door Adjustable Shelf</p>
	10761	10762	10765	10766
29H				
32H 35H				
41H				

BASE

Combination Storage

6 1/8"H top drawer fronts align with other noted 6 1/8"H drawer and false fronts.



Combination Storage

W: 18,21,24,27,30,33,36
H: 29,32,35,41
D: 18,21,24,29

Adjustable Shelves
 (32H-41H only)
 Drawer

W: 15,18,21,24,27,30,
 33,36
H: 29,32,35,41
D: 14,18,21,24,29

Drawer: 6 1/8"H Front
 Adjustable Shelf

W: 30,33,36
H: 29,32,35,41
D: 14,18,21,24,29

2 Drawers: 6 1/8"H Fronts
 Adjustable Shelf

W: 24,27,30,33,36
H: 29,32,35,41
D: 14,18,21,24,29

Drawer: 6 1/8"H Front
 Doors
 Adjustable Shelf

10419

10420

10431

10430

29H

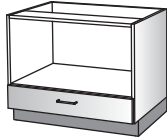

**32H
 35H**





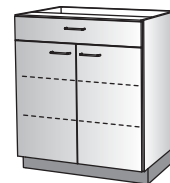









41H



Combination Storage

6 1/8"H top drawer fronts align with other noted 6 1/8"H drawer and false fronts.

Combination Storage				
	<p>W: 15,18,21,24 H: 29,32,35,41 D: 14,18,21,24,29</p> <p>Drawer: 6 1/8"H Front Right Hinge Door Adjustable Shelf</p>	<p>W: 15,18,21,24 H: 29,32,35,41 D: 14,18,21,24,29</p> <p>Drawer: 6 1/8"H Front Left Hinge Door Adjustable Shelf</p>	<p>W: 15,18,21,24 H: 29,32,35,41 D: 14,18,21,24,29</p> <p>Right Hinge Door Adjustable Shelf Drawer</p>	<p>W: 15,18,21,24 H: 29,32,35,41 D: 14,18,21,24,29</p> <p>Left Hinge Door Adjustable Shelf Drawer</p>
	10421	10422	10416	10417
29H				
32H 35H				
41H				

BASE

Combination Storage

6 1/8" H top drawer fronts align with other noted 6 1/8" H drawer and false fronts.



Combination Storage

W: 30,33,36,39,42,45,48
H: 29,32,35,41
D: 14,18,21,24,29

2 Drawers: 6 1/8" H Fronts
Doors
Adjustable Shelf

W: 39,42,45,48
H: 29,32,35,41
D: 14,18,21,24,29

Drawer: 6 1/8" H Front
Center Divider
Adjustable Shelves

W: 39,42,45,48
H: 29,32,35,41
D: 14,18,21,24,29

Drawer: 6 1/8" H Front
Doors
Center Divider
Adjustable Shelves

W: 30,33,36,39,42,45,48
H: 29,32,35,41
D: 14,18,21,24,29

2 Drawers: 6 1/8" H Fronts
Center Divider
Adjustable Shelves

W: 30,33,36,39,42,45,48
H: 29,32,35,41
D: 14,18,21,24,29

2 Drawers: 6 1/8" H Fronts
Doors
Center Divider
Adjustable Shelves

10432

10433

10446

10434

10441

29H

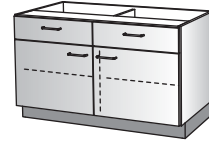
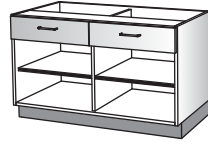
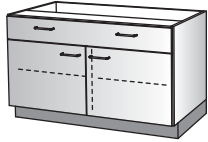
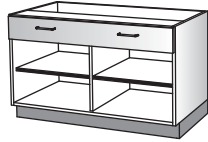
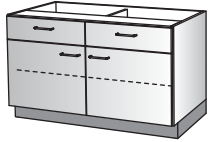



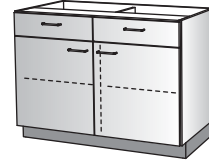
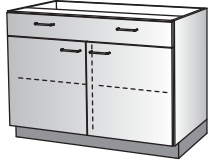
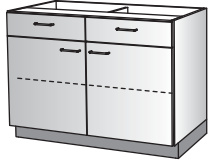



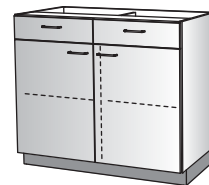

**32H
35H**



41H

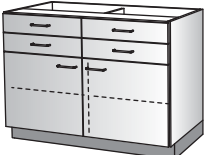

Combination Storage				
	<p>W: 15,18,21,24 H: 32,35 D: 14,18,21,24,29</p> <p>2 Equal Drawers Right Hinge Door Adjustable Shelf</p>	<p>W: 15,18,21,24 H: 32,35 D: 14,18,21,24,29</p> <p>2 Equal Drawers Left Hinge Door Adjustable Shelf</p>	<p>W: 24,27,30,33,36 H: 32,35 D: 14,18,21,24,29</p> <p>2 Equal Drawers Doors Adjustable Shelf</p>	<p>W: 39,42,45,48 H: 32,35 D: 14,18,21,24,29</p> <p>2 Equal Drawers Doors Adjustable Shelf</p>
	10741	10742	10748	10768
32H 35H				





Combination Storage					
	<p>W: 30,33,36,39,42,45,48 H: 32,35 D: 14,18,21,24,29</p> <p>4 Equal Drawers 2 Equal Deep Drawers Right Hinge Door Adjustable Shelf</p>	<p>W: 30,33,36,39,42,45,48 H: 32,35 D: 14,18,21,24,29</p> <p>4 Equal Drawers 2 Equal Deep Drawers Left Hinge Door Adjustable Shelf</p>	<p>W: 30,33,36,39,42,45,48 H: 32,35 D: 14,18,21,24,29</p> <p>4 Equal Drawers Doors Center Divider Adjustable Shelves</p>	<p>W: 30,33,36,39,42,45,48 H: 32,35 D: 14,18,21,24,29</p> <p>Left: Deep Drawer Right: 2 Equal Drawers Doors Center Divider Adjustable Shelves</p>	<p>W: 30,33,36,39,42,45,48 H: 32,35 D: 14,18,21,24,29</p> <p>Left: 2 Equal Drawers Right: Deep Drawer Doors Center Divider Adjustable Shelves</p>
	10745	10746	10750	10752	10754
32H 35H					

BASE

Pull Board

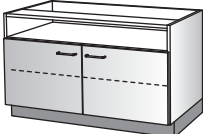

Pull Board				
	<p>W: 15,18,21,24 H: 29,32,35,41 D: 14,18,21,24,29</p> <p>Pull Board 3 Drawers</p>	<p>W: 15,18,21,24,27,30,33,36 H: 29,32,35,41 D: 14,18,21,24,29</p> <p>Pull Board Drawer Adjustable Shelf</p>	<p>W: 15,18,21,24 H: 29,32,35,41 D: 14,18,21,24,29</p> <p>Pull Board Drawer Right Hinge Door Adjustable Shelf</p>	<p>W: 15,18,21,24 H: 29,32,35,41 D: 14,18,21,24,29</p> <p>Pull Board Drawer Left Hinge Door Adjustable Shelf</p>
	10379	10424	10425	10426
29H				
32H 35H				
41H				

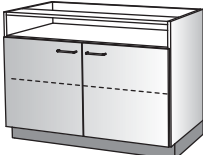
Book Box			
	<p>W: 15,18,21,24 H: 29,32,35 D: 14,18,21,24,29</p> <p>5½"H Open Compartment (Book Box) Right Hinge Door Adjustable Shelf</p>	<p>W: 15,18,21,24 H: 29,32,35 D: 14,18,21,24,29</p> <p>5½"H Open Compartment (Book Box) Left Hinge Door Adjustable Shelf</p>	<p>W: 27,30,33,36,39,42,45,48 H: 29,32,35 D: 14,18,21,24,29</p> <p>5½"H Open Compartment (Book Box) Doors Adjustable Shelf</p>
	10450	10451	10448
29H			
32H 35H			

BASE

Open Bottom



Open Bottom

W: 27,30,33,36,39,42,45,48
H: 29,32,35,41
D: 18,21,24,29

Open Compartment

W: 27,30,33,36,39,42,45,48
H: 29,32,35,41
D: 18,21,24,29

Open Bottom
Doors with Attached Toe Kicks
(see Design Details)

W: 27,30,33,36,39,42,45,48
H: 29,32,35,41
D: 18,21,24,29

Open Compartment
Toe Kick Notch in End Panels

W: 27,30,33,36,39,42,45,48
H: 29,32,35,41
D: 18,21,24,29

Open Bottom
Doors
Toe Kick Notch in End Panels

10702

10704

10703





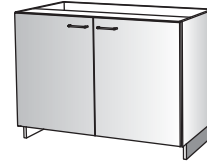
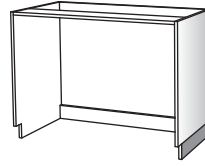
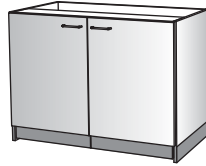
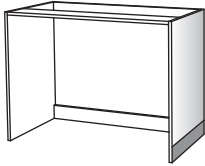

10705



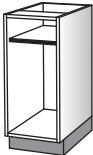

29H
32H
35H
41H

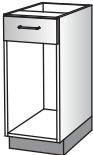

Media Integration

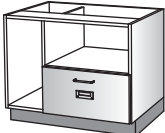
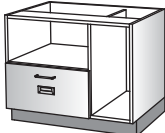
6 1/8"H top drawer fronts align with other noted 6 1/8"H drawer and false fronts.

Media Integration						
CPU Media Storage						
	<p>W: 12,15 H: 29,32,35 D: 21,24</p> <p>Adjustable Shelf</p>	<p>W: 12,15 H: 29,32,35 D: 21,24</p> <p>Right Hinge Door 10892 CPU Vents (color linked to accent color option) Adjustable Shelf</p>	<p>W: 12,15 H: 29,32,35 D: 21,24</p> <p>Left Hinge Door 10892 CPU Vents (color linked to accent color option) Adjustable Shelf</p>	<p>W: 12,15 H: 32,35 D: 21,24</p> <p>Drawer: 6 1/8"H Front</p>	<p>W: 12,15 H: 32,35 D: 21,24</p> <p>Drawer: 6 1/8"H Front Right Hinge Door 10892 CPU Vents (color linked to accent color option)</p>	<p>W: 12,15 H: 32,35 D: 21,24</p> <p>Drawer: 6 1/8"H Front Left Hinge Door 10892 CPU Vents (color linked to accent color option)</p>
	10123	10124	10125	10126	10127	10128
29H						
32H 35H						

Media Integration					
CPU/File Media Storage					
	<p>W: 36 H: 29 D: 21,24</p> <p>Left: CPU Compartment Right: Open Compartment, Full Extension Lateral File Drawer</p>	<p>W: 36 H: 29 D: 21,24</p> <p>Left: Open Compartment, Full Extension Lateral File Drawer Right: CPU Compartment</p>	<p>W: 24 H: 29,35 D: 21,24</p> <p>Adjustable Shelf (35H only) Full Extension Lateral File Drawer</p>	<p>W: 36 H: 35 D: 21,24</p> <p>Left: CPU Compartment Right: Adjustable Shelf Full Extension Lateral File Drawer</p>	<p>W: 36 H: 35 D: 21,24</p> <p>Left: Adjustable Shelf Right: CPU Compartment Full Extension Lateral File Drawer</p>
	10722	10723	10721	10724	10725
29H					
35H					

BASE

Memo Desk



Memo Desk

W: 30,33,36
H: 29,35
D: 21,24

Drawer
Color Interior
29H=Sit-Down
35H=Stand-Up

W: 39,42,45,48
H: 29,35
D: 21,24

2 Drawers
Color Interior
29H=Sit-Down
35H=Stand-Up

10672

10673

29H
35H

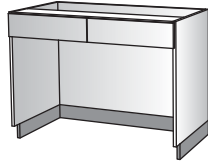
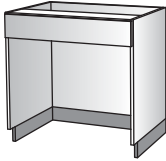

Memo Desk – ADA

W: 33,36
H: 32
D: 21,24

Drawer
Color Interior

W: 39,42,45,48
H: 32
D: 21,24

2 Drawers
Color Interior

10578

10579

32H

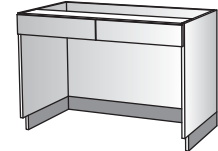
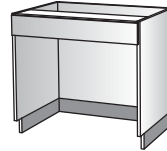

Memo Desk – Wall

W: 30,33,36
H: 22
D: 21,24,29

Drawer
Shelf
Color Interior

W: 39,42,45,48
H: 22
D: 21,24,29

2 Drawers
Shelf
Color Interior

10674



10675

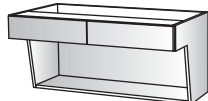
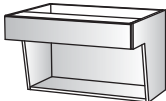

22H

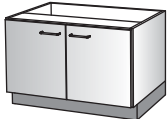

Sink Base

6 1/8" H top drawer fronts align with other noted 6 1/8" H drawer and false fronts.

Sink Base			
	W: 18,21,24 H: 24,29,32,35 D: 21,24,29 Right Hinge Door Removable Back	W: 18,21,24 H: 24,29,32,35 D: 21,24,29 Left Hinge Door Removable Back	W: 30,33,36,39,42,45,48 H: 24,29,32,35 D: 21,24,29 Doors Removable Back
	10473	10474	10475
24H 29H 32H 35H			

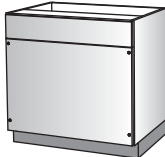
Sink Base				
	W: 18,21,24 H: 29,32,35,41 D: 21,24,29 6 1/8" H False Front Right Hinge Door Removable Back	W: 18,21,24 H: 29,32,35,41 D: 21,24,29 6 1/8" H False Front Left Hinge Door Removable Back	W: 30,33,36,39,42,45,48 H: 29,32,35,41 D: 21,24,29 6 1/8" H False Front Doors Removable Back	W: 18,21,24,27,30,33, 36,39,42,45,48 H: 29,32,35,41 D: 24,29 6 1/8" H False Front Front Access Panel Removable Back
	10477	10478	10479	10464
29H 32H 35H 41H				

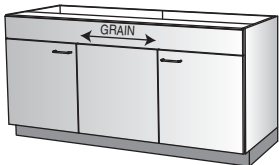
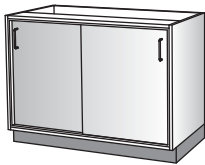
Sink Base	
W: 54,60,66,72 H: 29,32,35 D: 21,24,29 6 1/8" H False Front Doors Removable Backs	W: 30,33,36,39,42,45,48 H: 29,32,35 D: 24,29 Sliding Doors Removable Back
10480	10481
29H 32H 35H	 

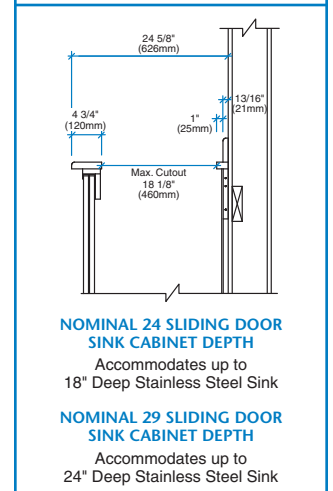
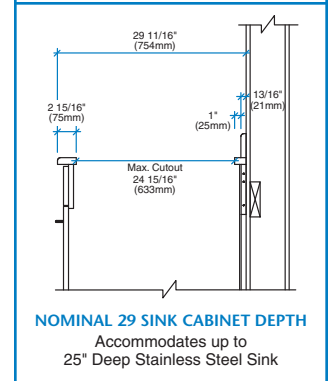
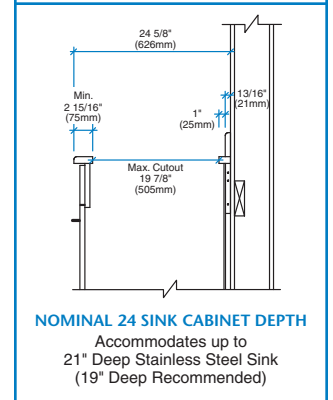
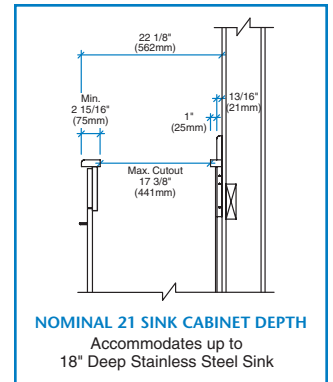

BASE

Sink Base / Wall Sink

6 1/8"H top drawer fronts align with other noted 6 1/8"H drawer and false fronts.



Sink Base – Open Bottom

W: 30,33,36,39,42,45,48
H: 29,32,35,41
D: 21,24,29

Open Bottom
6 1/8"H False Front
Doors with Attached Toe Kicks
(see Design Details)
Removable Back
Not ADA Compliant

W: 30,33,36,39,42,45,48
H: 29,32,35,41
D: 21,24,29

Open Bottom
6 1/8"H False Front
Doors
Removable Back
Not ADA Compliant

W: 30,33,36,39,42,45,48
H: 29,32,35,41
D: 21,24,29

Open Bottom
Doors
Removable Back

10460

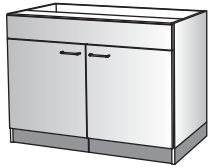

10461

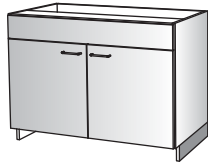

10476

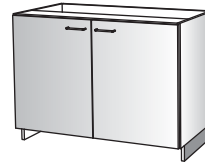

29H
32H
35H
41H

Sink Base – Diagonal Corner

W: 30
H: 32,35
D: 21,24

Right Hinge Door
Waste Slot
Waste Receptacle

W: 30
H: 32,35
D: 21,24

Left Hinge Door
Waste Slot
Waste Receptacle

10469

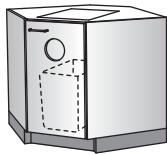

10470

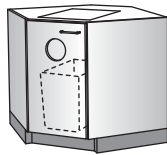

32H
35H

Wall Sink

W: 30,33,36,39,42,45,48
H: 22
D: 21,24

Access Panel
Not ADA Compliant

10511

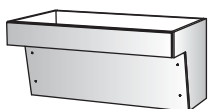

22H

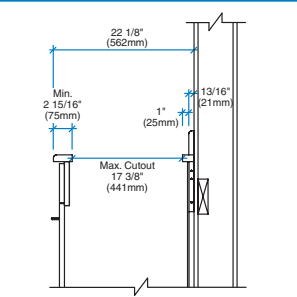

NOMINAL 21 SINK CABINET DEPTH

Accommodates up to 18" Deep Stainless Steel Sink

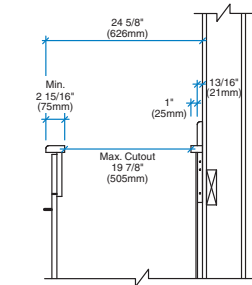

NOMINAL 24 SINK CABINET DEPTH

Accommodates up to 21" Deep Stainless Steel Sink (19" Deep Recommended)

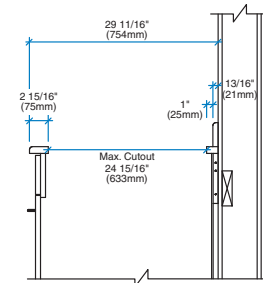

NOMINAL 29 SINK CABINET DEPTH

Accommodates up to 25" Deep Stainless Steel Sink

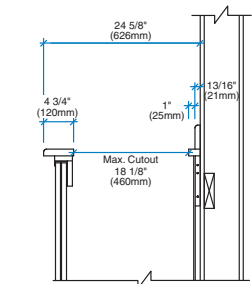

NOMINAL 24 SLIDING DOOR SINK CABINET DEPTH

Accommodates up to 18" Deep Stainless Steel Sink

NOMINAL 29 SLIDING DOOR SINK CABINET DEPTH

Accommodates up to 24" Deep Stainless Steel Sink

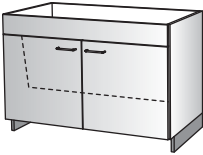
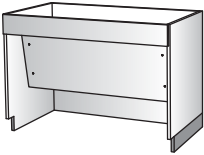
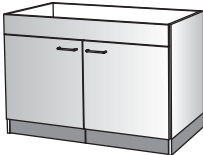
ADA Sink Base				
Adult Size				
	<p>W: 39,42,45,48 H: 32 D: 24,29</p> <p>Meets ADA Requirements for Adult Sizing Pocket Doors Access Panel</p>	<p>W: 33,36,39,42,45,48 H: 32 D: 24,29</p> <p>Meets ADA Requirements for Adult Sizing Doors Access Panel</p>	<p>W: 33,36,39,42,45,48 H: 32 D: 24,29</p> <p>Meets ADA Requirements for Adult Sizing Access Panel Color Interior</p>	<p>W: 30,33,36,39,42,45,48 H: 32 D: 24,29</p> <p>Open Bottom Meets ADA Requirements for Adult Sizing Doors with Attached Toe Kicks (see Design Details) Removable Back</p>
	10572	10574	10576	10678
32H				

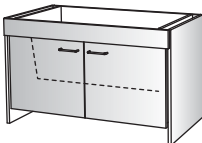
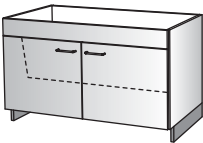
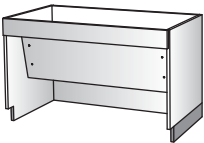
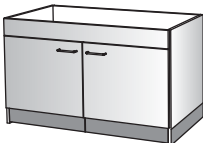
ADA Sink Base				
Child Size				
	<p>W: 39,42,45,48 H: 29 D: 24,29</p> <p>Meets ADA Requirements for Child Sizing Pocket Doors Access Panel</p>	<p>W: 33,36,39,42,45,48 H: 29 D: 24,29</p> <p>Meets ADA Requirements for Child Sizing Doors Access Panel</p>	<p>W: 33,36,39,42,45,48 H: 29 D: 24,29</p> <p>Meets ADA Requirements for Child Sizing Access Panel Color Interior</p>	<p>W: 30,33,36,39,42,45,48 H: 29 D: 24,29</p> <p>Open Bottom Meets ADA Requirements for Child Sizing Doors with Attached Toe Kicks (see Design Details) Removable Back</p>
	10573	10575	10577	10679
29H				

BASE

ADA Sink Base



ADA Sink Base

Convertible

W: 39,42

H: 32

D: 24

For ADA or Conventional Use
Pocket Doors
Access Panel

10472

32H

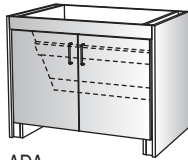

ADA
(doors closed)

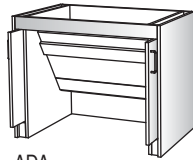

ADA
(doors open)

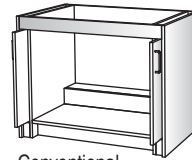

Conventional
(doors open)

For conventional use,
access panel folds down
to form cabinet bottom.

**ADA Wall Sink
Laminate Faced**

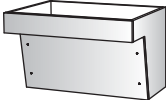
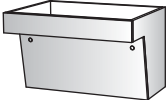
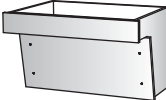
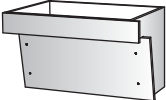
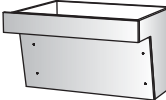
	ADA Wall Sink		ADA Wall Sink – Trimmable		
	Adult Size		Adult Size		
	W: 30,33,36,39,42,45,48 H: 22 D: 24,29 Meets ADA Requirements for Adult Sizing Full Enclosure Design Laminate Faced Access Panel	W: 30,33,36,39,42,45,48 H: 22 D: 24,29 Meets ADA Requirements for Adult Sizing Full Enclosure Design Laminate Faced Hinged, Locked Access Panel	W: 30 - 48 (1" increments) H: 22 D: 24,29 Center Style Trimmable, Right and Left Ends Meets ADA Requirements for Adult Sizing Full Enclosure Design Laminate Faced Access Panel Cabinet Body is 2" Narrower than Widths Shown	W: 30 - 48 (1" increments) H: 22 D: 24,29 Right Extended Style Trimmable, Right End Only Meets ADA Requirements for Adult Sizing Full Enclosure Design Laminate Faced Access Panel Cabinet Body is 2" Narrower than Widths Shown	W: 30 - 48 (1" increments) H: 22 D: 24,29 Left Extended Style Trimmable, Left End Only Meets ADA Requirements for Adult Sizing Full Enclosure Design Laminate Faced Access Panel Cabinet Body is 2" Narrower than Widths Shown
	10580	10582	10584	10586	10588
22H					

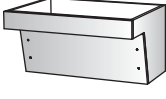
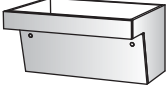
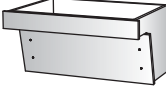
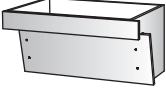
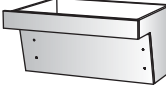
	ADA Wall Sink		ADA Wall Sink – Trimmable		
	Child Size		Child Size		
	W: 30,33,36,39,42,45,48 H: 18 D: 24,29 Meets ADA Requirements for Child Sizing Full Enclosure Design Laminate Faced Access Panel	W: 30,33,36,39,42,45,48 H: 18 D: 24,29 Meets ADA Requirements for Child Sizing Full Enclosure Design Laminate Faced Hinged, Locked Access Panel	W: 30 - 48 (1" increments) H: 18 D: 24,29 Center Style Trimmable, Right and Left Ends Meets ADA Requirements for Child Sizing Full Enclosure Design Laminate Faced Access Panel Cabinet Body is 2" Narrower than Widths Shown	W: 30 - 48 (1" increments) H: 18 D: 24,29 Right Extended Style Trimmable, Right End Only Meets ADA Requirements for Child Sizing Full Enclosure Design Laminate Faced Access Panel Cabinet Body is 2" Narrower than Widths Shown	W: 30 - 48 (1" increments) H: 18 D: 24,29 Left Extended Style Trimmable, Left End Only Meets ADA Requirements for Child Sizing Full Enclosure Design Laminate Faced Access Panel Cabinet Body is 2" Narrower than Widths Shown
	10581	10583	10585	10587	10589
18H					

BASE

ADA Wall Sink Solid Surface







	ADA Wall Sink	ADA Wall Sink – Trimmable		
	Adult Size	Adult Size		
	W: 30,33,36,39,42,45,48 H: 22 D: 24,29 Meets ADA Requirements for Adult Sizing Full Enclosure Design Solid Surface Access Panel Includes Matching Solid Surface Overlay End Panels, if required (factory-applied) Matching Solid Surface Overlay Apron Available Separately (10948/10949) Each Solid Surface Overlay End Panel Adds 1/2" to Overall Width of Unit	W: 30 - 48 (1" increments) H: 22 D: 24,29 Center Style Trimmable, Right and Left Ends Meets ADA Requirements for Adult Sizing Full Enclosure Design Solid Surface Access Panel Matching Solid Surface Overlay Apron Available Separately (10948/10949) Cabinet Body is 2" Narrower than Widths Shown	W: 30 - 48 (1" increments) H: 22 D: 24,29 Right Extended Style Trimmable, Right End Only Meets ADA Requirements for Adult Sizing Full Enclosure Design Solid Surface Access Panel Includes Matching Solid Surface Overlay End Panel, if required (factory-applied) Matching Solid Surface Overlay Apron Available Separately (10948/10949) Cabinet Body is 2" Narrower than Widths Shown Solid Surface Overlay End Panel Adds 1/2" to Overall Width of Unit	W: 30 - 48 (1" increments) H: 22 D: 24,29 Left Extended Style Trimmable, Left End Only Meets ADA Requirements for Adult Sizing Full Enclosure Design Solid Surface Access Panel Includes Matching Solid Surface Overlay End Panel, if required (factory-applied) Matching Solid Surface Overlay Apron Available Separately (10948/10949) Cabinet Body is 2" Narrower than Widths Shown Solid Surface Overlay End Panel Adds 1/2" to Overall Width of Unit
	10590	10592	10594	10596
22H				

10592,10594,10596 shown with Solid Surface Overlay Apron (available separately, see next page)

	ADA Wall Sink	ADA Wall Sink – Trimmable		
	Child Size	Child Size		
	W: 30,33,36,39,42,45,48 H: 18 D: 24,29 Meets ADA Requirements for Child Sizing Full Enclosure Design Solid Surface Access Panel Includes Matching Solid Surface Overlay End Panels, if required (factory-applied) Matching Solid Surface Overlay Apron Available Separately (10943/10944) Each Solid Surface Overlay End Panel Adds 1/2" to Overall Width of Unit	W: 30 - 48 (1" increments) H: 18 D: 24,29 Center Style Trimmable, Right and Left Ends Meets ADA Requirements for Child Sizing Full Enclosure Design Solid Surface Access Panel Matching Solid Surface Overlay Apron Available Separately (10943/10944) Cabinet Body is 2" Narrower than Widths Shown	W: 30 - 48 (1" increments) H: 18 D: 24,29 Right Extended Style Trimmable, Right End Only Meets ADA Requirements for Child Sizing Full Enclosure Design Solid Surface Access Panel Includes Matching Solid Surface Overlay End Panel, if required (factory-applied) Matching Solid Surface Overlay Apron Available Separately (10943/10944) Cabinet Body is 2" Narrower than Widths Shown Solid Surface Overlay End Panel Adds 1/2" to Overall Width of Unit	W: 30 - 48 (1" increments) H: 18 D: 24,29 Left Extended Style Trimmable, Left End Only Meets ADA Requirements for Child Sizing Full Enclosure Design Solid Surface Access Panel Includes Matching Solid Surface Overlay End Panel, if required (factory-applied) Matching Solid Surface Overlay Apron Available Separately (10943/10944) Cabinet Body is 2" Narrower than Widths Shown Solid Surface Overlay End Panel Adds 1/2" to Overall Width of Unit
	10591	10593	10595	10597
18H				

10593,10595,10597 shown with Solid Surface Overlay Apron (available separately, see next page)

ADA Wall Sink	
Solid Surface Overlay Apron – Adult Size	
<p>W: 30,33,36,39,42,45,48 H: 05 D: 00</p> <p>For Use with Individual 10590, 10592, 10594 and 10596 Adult ADA Wall Sinks Field Applied in Pattern to Match Solid Surface Access Panels Actual Height=133mm</p>	<p>W: 60 - 144 (1" increments) H: 05 D: 00</p> <p>For Use with Continuous Run of 10590, 10592, 10594 and 10596 Adult ADA Wall Sinks Field Applied in Pattern to Match Solid Surface Access Panels Actual Height=133mm</p>
10948	10949
	

ADA Wall Sink	
Solid Surface Overlay Apron – Child Size	
<p>W: 30,33,36,39,42,45,48 H: 05 D: 00</p> <p>For Use with Individual 10591, 10593, 10595 and 10597 Child ADA Wall Sinks Field Applied in Pattern to Match Solid Surface Access Panels Actual Height=115mm</p>	<p>W: 60 - 144 (1" increments) H: 05 D: 00</p> <p>For Use with Continuous Run of 10591, 10593, 10595 and 10597 Child ADA Wall Sinks Field Applied in Pattern to Match Solid Surface Access Panels Actual Height=115mm</p>
10943	10944
	

BASE

Steel Frame Wall Vanity Laminate Faced

Nominal Top Depths:
22" (for 21D Vanities); 25" (for 24D Vanities)

Suitable for use with laminate, solid surface, quartz, granite, marble and other top materials.



Double Steel Frame Wall Vanity – Adult Size

Sink Centers
60W = 30"
66W = 33"
72W = 36"
84W = 42"
90W = 45"
96W = 48"

W: 60,66,72,84,90,96
H: 24
D: 21,24

Finished End Panels
Meets ADA Requirements for Adult Sizing
Laminate Faced Aprons, End Panels, Access Panels
Steel Wall Framing Construction
Field Bolt-Together Installation

W: 60,66,72,84,90,96
H: 24
D: 21,24

Wall-to-Wall Installation
Meets ADA Requirements for Adult Sizing
Laminate Faced Aprons and Access Panels
Steel Wall Framing Construction
Field Bolt-Together Installation

W: 60,66,72,84,90,96
H: 24
D: 21,24

Corner Installation (left hand or right hand)
Meets ADA Requirements for Adult Sizing
Laminate Faced Aprons, End Panels, Access Panels
Steel Wall Framing Construction
Field Bolt-Together Installation

10502

10505

10508

24H

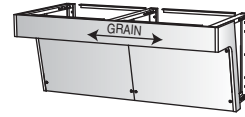
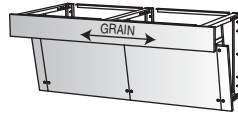
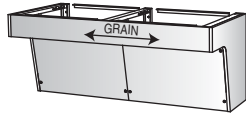

(right hand corner unit shown)

Triple Steel Frame Wall Vanity – Adult Size

Sink Centers
90W = 30"
99W = 33"
108W = 36"
126W = 42"
135W = 45"
144W = 48"

W: 90,99,108,126,135,144
H: 24
D: 21,24

Finished End Panels
Meets ADA Requirements for Adult Sizing
Laminate Faced Aprons, End Panels, Access Panels
Steel Wall Framing Construction
Field Bolt-Together Installation

W: 90,99,108,126,135,144
H: 24
D: 21,24

Wall-to-Wall Installation
Meets ADA Requirements for Adult Sizing
Laminate Faced Aprons and Access Panels
Steel Wall Framing Construction
Field Bolt-Together Installation

W: 90,99,108,126,135,144
H: 24
D: 21,24

Corner Installation (left hand or right hand)
Meets ADA Requirements for Adult Sizing
Laminate Faced Aprons, End Panels, Access Panels
Steel Wall Framing Construction
Field Bolt-Together Installation

10503

10506

10509

24H

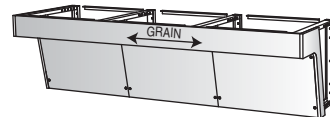
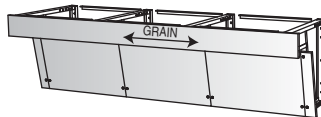
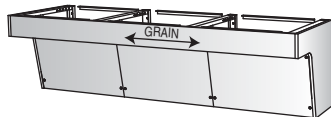

(right hand corner unit shown)

Quad Steel Frame Wall Vanity – Adult Size

Sink Centers
120W = 30"
132W = 33"
144W = 36"

W: 120,132,144
H: 24
D: 21,24

Finished End Panels
Meets ADA Requirements for Adult Sizing
Laminate Faced Aprons, End Panels, Access Panels
Steel Wall Framing Construction
Field Bolt-Together Installation

W: 120,132,144
H: 24
D: 21,24

Wall-to-Wall Installation
Meets ADA Requirements for Adult Sizing
Laminate Faced Aprons and Access Panels
Steel Wall Framing Construction
Field Bolt-Together Installation

W: 120,132,144
H: 24
D: 21,24

Corner Installation (left hand or right hand)
Meets ADA Requirements for Adult Sizing
Laminate Faced Aprons, End Panels, Access Panels
Steel Wall Framing Construction
Field Bolt-Together Installation

10504

10507

10510

24H

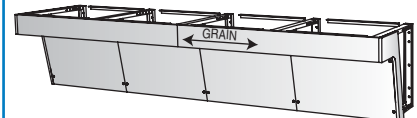
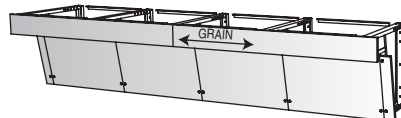
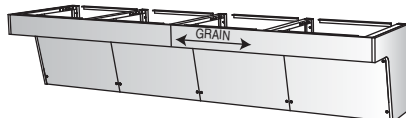

(right hand corner unit shown)

Suitable for use with laminate, solid surface, quartz, granite, marble and other top materials.

**Steel Frame Wall Vanity
Laminate Faced**

Nominal Top Depths:
22" (for 21D Vanities); 25" (for 24D Vanities)

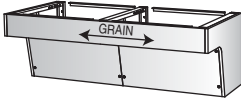
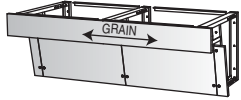
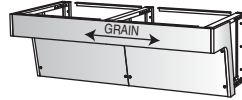
Double Steel Frame Wall Vanity – Child Size			
<p>Sink Centers 60W = 30" 66W = 33" 72W = 36" 84W = 42" 90W = 45" 96W = 48"</p>	<p>W: 60,66,72,84,90,96 H: 20 D: 21,24</p> <p>Finished End Panels Meets ADA Requirements for Child Sizing Laminate Faced Aprons, End Panels, Access Panels Steel Wall Framing Construction Field Bolt-Together Installation</p>	<p>W: 60,66,72,84,90,96 H: 20 D: 21,24</p> <p>Wall-to-Wall Installation Meets ADA Requirements for Child Sizing Laminate Faced Aprons and Access Panels Steel Wall Framing Construction Field Bolt-Together Installation</p>	<p>W: 60,66,72,84,90,96 H: 20 D: 21,24</p> <p>Corner Installation (left hand or right hand) Meets ADA Requirements for Child Sizing Laminate Faced Aprons, End Panels, Access Panels Steel Wall Framing Construction Field Bolt-Together Installation</p>
	<p>10612</p> 	<p>10615</p> 	<p>10618</p>  <p>(right hand corner unit shown)</p>

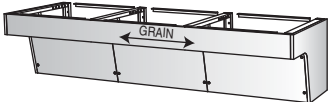
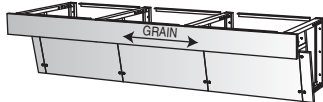
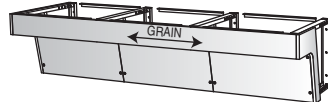
Triple Steel Frame Wall Vanity – Child Size			
<p>Sink Centers 90W = 30" 99W = 33" 108W = 36" 126W = 42" 135W = 45" 144W = 48"</p>	<p>W: 90,99,108,126,135,144 H: 20 D: 21,24</p> <p>Finished End Panels Meets ADA Requirements for Child Sizing Laminate Faced Aprons, End Panels, Access Panels Steel Wall Framing Construction Field Bolt-Together Installation</p>	<p>W: 90,99,108,126,135,144 H: 20 D: 21,24</p> <p>Wall-to-Wall Installation Meets ADA Requirements for Child Sizing Laminate Faced Aprons and Access Panels Steel Wall Framing Construction Field Bolt-Together Installation</p>	<p>W: 90,99,108,126,135,144 H: 20 D: 21,24</p> <p>Corner Installation (left hand or right hand) Meets ADA Requirements for Child Sizing Laminate Faced Aprons, End Panels, Access Panels Steel Wall Framing Construction Field Bolt-Together Installation</p>
	<p>10613</p> 	<p>10616</p> 	<p>10619</p>  <p>(right hand corner unit shown)</p>

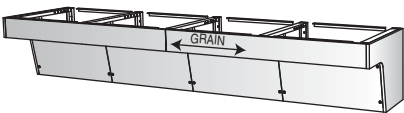
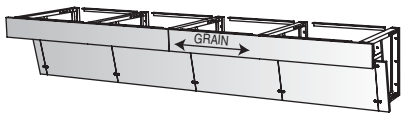
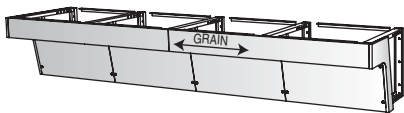
Quad Steel Frame Wall Vanity – Child Size			
<p>Sink Centers 120W = 30" 132W = 33" 144W = 36"</p>	<p>W: 120,132,144 H: 20 D: 21,24</p> <p>Finished End Panels Meets ADA Requirements for Child Sizing Laminate Faced Aprons, End Panels, Access Panels Steel Wall Framing Construction Field Bolt-Together Installation</p>	<p>W: 120,132,144 H: 20 D: 21,24</p> <p>Wall-to-Wall Installation Meets ADA Requirements for Child Sizing Laminate Faced Aprons and Access Panels Steel Wall Framing Construction Field Bolt-Together Installation</p>	<p>W: 120,132,144 H: 20 D: 21,24</p> <p>Corner Installation (left hand or right hand) Meets ADA Requirements for Child Sizing Laminate Faced Aprons, End Panels, Access Panels Steel Wall Framing Construction Field Bolt-Together Installation</p>
	<p>10614</p> 	<p>10617</p> 	<p>10620</p>  <p>(right hand corner unit shown)</p>

BASE

Steel Frame Wall Vanity Solid Surface

Nominal Top Depths:
22" (for 21D Vanities); 25" (for 24D Vanities)

Suitable for use with laminate, solid surface, quartz, granite, marble and other top materials.



Double Steel Frame Wall Vanity – Adult Size

Sink Centers
60W = 30"
66W = 33"
72W = 36"
84W = 42"
90W = 45"
96W = 48"

W: 60,66,72,84,90,96
H: 24
D: 21,24

Finished End Panels
Meets ADA Requirements for Adult Sizing
Solid Surface Aprons, End Panels, Access Panels
Steel Wall Framing Construction
Field Bolt-Together Installation

W: 60,66,72,84,90,96
H: 24
D: 21,24

Wall-to-Wall Installation
Meets ADA Requirements for Adult Sizing
Solid Surface Aprons and Access Panels
Steel Wall Framing Construction
Field Bolt-Together Installation

W: 60,66,72,84,90,96
H: 24
D: 21,24

Corner Installation (left hand or right hand)
Meets ADA Requirements for Adult Sizing
Solid Surface Aprons, End Panels, Access Panels
Steel Wall Framing Construction
Field Bolt-Together Installation

10602

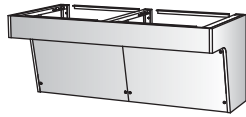

10605

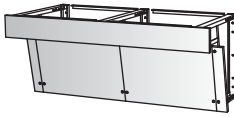

10608

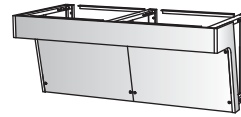

(right hand corner unit shown)

24H

Triple Steel Frame Wall Vanity – Adult Size

Sink Centers
90W = 30"
99W = 33"
108W = 36"
126W = 42"
135W = 45"
144W = 48"

W: 90,99,108,126,135,144
H: 24
D: 21,24

Finished End Panels
Meets ADA Requirements for Adult Sizing
Solid Surface Aprons, End Panels, Access Panels
Steel Wall Framing Construction
Field Bolt-Together Installation

W: 90,99,108,126,135,144
H: 24
D: 21,24

Wall-to-Wall Installation
Meets ADA Requirements for Adult Sizing
Solid Surface Aprons and Access Panels
Steel Wall Framing Construction
Field Bolt-Together Installation

W: 90,99,108,126,135,144
H: 24
D: 21,24

Corner Installation (left hand or right hand)
Meets ADA Requirements for Adult Sizing
Solid Surface Aprons, End Panels, Access Panels
Steel Wall Framing Construction
Field Bolt-Together Installation

10603

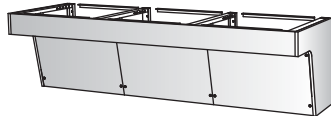

10606

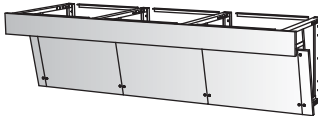

10609

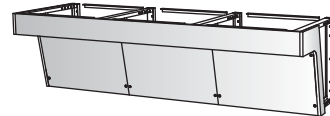

(right hand corner unit shown)

24H

Quad Steel Frame Wall Vanity – Adult Size

Sink Centers
120W = 30"
132W = 33"
144W = 36"

W: 120,132,144
H: 24
D: 21,24

Finished End Panels
Meets ADA Requirements for Adult Sizing
Solid Surface Aprons, End Panels, Access Panels
Steel Wall Framing Construction
Field Bolt-Together Installation

W: 120,132,144
H: 24
D: 21,24

Wall-to-Wall Installation
Meets ADA Requirements for Adult Sizing
Solid Surface Aprons and Access Panels
Steel Wall Framing Construction
Field Bolt-Together Installation

W: 120,132,144
H: 24
D: 21,24

Corner Installation (left hand or right hand)
Meets ADA Requirements for Adult Sizing
Solid Surface Aprons, End Panels, Access Panels
Steel Wall Framing Construction
Field Bolt-Together Installation

10604

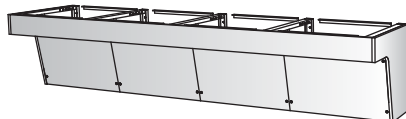

10607

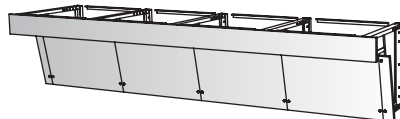

10610

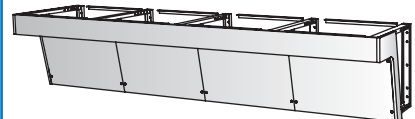

(right hand corner unit shown)

24H

Suitable for use with laminate, solid surface, quartz, granite, marble and other top materials.

**Steel Frame Wall Vanity
Solid Surface**

Nominal Top Depths:
22" (for 21D Vanities); 25" (for 24D Vanities)

Double Steel Frame Wall Vanity – Child Size			
Sink Centers 60W = 30" 66W = 33" 72W = 36" 84W = 42" 90W = 45" 96W = 48"	<p>W: 60,66,72,84,90,96 H: 20 D: 21,24</p> <p>Finished End Panels Meets ADA Requirements for Child Sizing Solid Surface Aprons, End Panels, Access Panels Steel Wall Framing Construction Field Bolt-Together Installation</p>	<p>W: 60,66,72,84,90,96 H: 20 D: 21,24</p> <p>Wall-to-Wall Installation Meets ADA Requirements for Child Sizing Solid Surface Aprons and Access Panels Steel Wall Framing Construction Field Bolt-Together Installation</p>	<p>W: 60,66,72,84,90,96 H: 20 D: 21,24</p> <p>Corner Installation (left hand or right hand) Meets ADA Requirements for Child Sizing Solid Surface Aprons, End Panels, Access Panels Steel Wall Framing Construction Field Bolt-Together Installation</p>
	<p>10632</p> 	<p>10635</p> 	<p>10638</p>  <p>(right hand corner unit shown)</p>
20H			

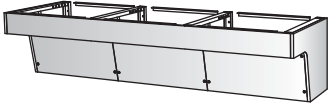
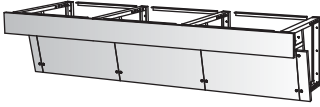
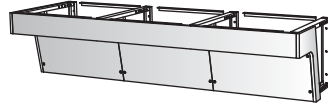
Triple Steel Frame Wall Vanity – Child Size			
Sink Centers 90W = 30" 99W = 33" 108W = 36" 126W = 42" 135W = 45" 144W = 48"	<p>W: 90,99,108,126,135,144 H: 20 D: 21,24</p> <p>Finished End Panels Meets ADA Requirements for Child Sizing Solid Surface Aprons, End Panels, Access Panels Steel Wall Framing Construction Field Bolt-Together Installation</p>	<p>W: 90,99,108,126,135,144 H: 20 D: 21,24</p> <p>Wall-to-Wall Installation Meets ADA Requirements for Child Sizing Solid Surface Aprons and Access Panels Steel Wall Framing Construction Field Bolt-Together Installation</p>	<p>W: 90,99,108,126,135,144 H: 20 D: 21,24</p> <p>Corner Installation (left hand or right hand) Meets ADA Requirements for Child Sizing Solid Surface Aprons, End Panels, Access Panels Steel Wall Framing Construction Field Bolt-Together Installation</p>
	<p>10633</p> 	<p>10636</p> 	<p>10639</p>  <p>(right hand corner unit shown)</p>
20H			

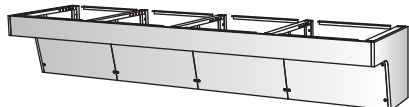
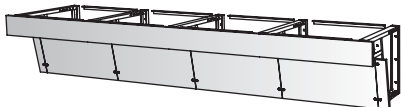
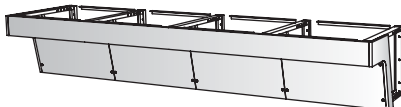
Quad Steel Frame Wall Vanity – Child Size			
Sink Centers 120W = 30" 132W = 33" 144W = 36"	<p>W: 120,132,144 H: 20 D: 21,24</p> <p>Finished End Panels Meets ADA Requirements for Child Sizing Solid Surface Aprons, End Panels, Access Panels Steel Wall Framing Construction Field Bolt-Together Installation</p>	<p>W: 120,132,144 H: 20 D: 21,24</p> <p>Wall-to-Wall Installation Meets ADA Requirements for Child Sizing Solid Surface Aprons and Access Panels Steel Wall Framing Construction Field Bolt-Together Installation</p>	<p>W: 120,132,144 H: 20 D: 21,24</p> <p>Corner Installation (left hand or right hand) Meets ADA Requirements for Child Sizing Solid Surface Aprons, End Panels, Access Panels Steel Wall Framing Construction Field Bolt-Together Installation</p>
	<p>10634</p> 	<p>10637</p> 	<p>10640</p>  <p>(right hand corner unit shown)</p>
20H			

BASE

Vanity Wall Closure



Vanity Wall Closure

W: 30,33,36,39,42,45,48

H: 19,24

D: 21,24,29

Access Panel
Not ADA Compliant

10512

19H
24H

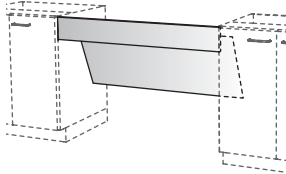

Vanity Wall Closure

ADA – Adult Size

W: 30,33,36,39,42,45,48

H: 22

D: 24,29

Meets ADA Requirements for Adult Sizing
Access Panel

10570

22H

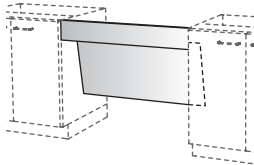

ADA – Child Size

W: 30,33,36,39,42,45,48

H: 18

D: 24,29



Meets ADA Requirements for Child Sizing
Access Panel



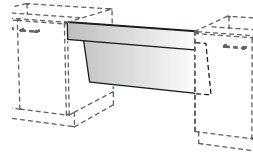

10571

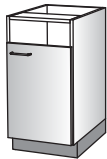
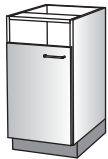
18H

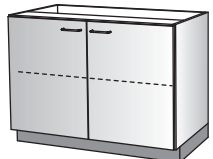

Trash / Cart Storage

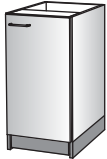
Trash Storage						
	<p>W: 15,18,21,24 H: 32,35,41 D: 18,21,24,29</p> <p>Upper Trash Opening Lower Right Hinge Door</p>	<p>W: 15,18,21,24 H: 32,35,41 D: 18,21,24,29</p> <p>Upper Trash Opening Lower Left Hinge Door</p>		<p>W: 15,18,21,24 H: 29,32,35,41 D: 18,21,24,29</p> <p>Right Hinge Door Adjustable Shelves Removable to Allow Use of Trash Receptacle (not included)</p>	<p>W: 15,18,21,24 H: 29,32,35,41 D: 18,21,24,29</p> <p>Left Hinge Door Adjustable Shelves Removable to Allow Use of Trash Receptacle (not included)</p>	<p>W: 27,30,33,36,39,42,45,48 H: 29,32,35,41 D: 18,21,24,29</p> <p>Doors Adjustable Shelves Removable to Allow Use of Trash Receptacle (not included)</p>
	10116	10117		10120	10121	10129
<p>32H 35H 41H</p>						
			<p>29H 32H 35H 41H</p>			

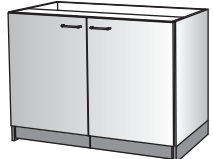
Trash/Cart Storage – Open Bottom						
	<p>W: 15,18,21,24 H: 32,35,41 D: 18,21,24,29</p> <p>Open Bottom Upper Trash Opening Lower Right Hinge Door with Attached Toe Kick (see Design Details)</p>	<p>W: 15,18,21,24 H: 32,35,41 D: 18,21,24,29</p> <p>Open Bottom Upper Trash Opening Lower Left Hinge Door with Attached Toe Kick (see Design Details)</p>		<p>W: 15,18,21,24 H: 29,32,35,41 D: 18,21,24,29</p> <p>Open Bottom Right Hinge Door with Attached Toe Kick (see Design Details)</p>	<p>W: 15,18,21,24 H: 29,32,35,41 D: 18,21,24,29</p> <p>Open Bottom Left Hinge Door with Attached Toe Kick (see Design Details)</p>	<p>W: 27,30,33,36,39,42,45,48 H: 29,32,35,41 D: 18,21,24,29</p> <p>Open Bottom Doors with Attached Toe Kicks (see Design Details)</p>
	10698	10699		10700	10701	10704
<p>32H 35H 41H</p>						
			<p>29H 32H 35H 41H</p>			

BASE

Trash / Cart Storage



Trash/Cart Storage – Open Bottom

W: 15,18,21,24
H: 32,35,41
D: 18,21,24,29

Open Bottom
Upper Trash Opening
Lower Right Hinge Door
Toe Kick Notch in End Panels

10707

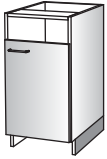

W: 15,18,21,24
H: 32,35,41
D: 18,21,24,29

Open Bottom
Upper Trash Opening
Lower Left Hinge Door
Toe Kick Notch in End Panels

10708



W: 15,18,21,24
H: 29,32,35,41
D: 18,21,24,29

Open Bottom
Right Hinge Door
Toe Kick Notch in End Panels

10711



W: 15,18,21,24
H: 29,32,35,41
D: 18,21,24,29

Open Bottom
Left Hinge Door
Toe Kick Notch in End Panels

10712



W: 27,30,33,36,39,42,45,48
H: 29,32,35,41
D: 18,21,24,29

Open Bottom
Doors
Toe Kick Notch in End Panels

10705

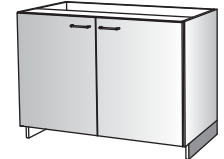

32H
35H
41H

29H
32H
35H
41H

Trash/Cart Storage – Open Bottom

W: 15,18,21,24
H: 32,35,41
D: 18,21,24,29

Open Bottom
Upper Trash Opening
Lower Right Hinge Full Height Door

10713



W: 15,18,21,24
H: 32,35,41
D: 18,21,24,29

Open Bottom
Upper Trash Opening
Lower Left Hinge Full Height Door

10714



W: 15,18,21,24
H: 29,32,35,41
D: 18,21,24,29

Open Bottom
Right Hinge Full Height Door

10715



W: 15,18,21,24
H: 29,32,35,41
D: 18,21,24,29

Open Bottom
Left Hinge Full Height Door

10716



W: 27,30,33,36,39,42,45,48
H: 29,32,35,41
D: 18,21,24,29





Open Bottom
Full Height Doors

10717

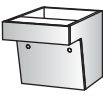

32H
35H
41H

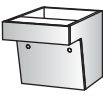
29H
32H
35H
41H

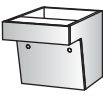
Trash Storage									
	<table border="1"> <thead> <tr> <th>ADA Wall Trash Module – Adult Size</th> <th>ADA Wall Trash Module – Child Size</th> </tr> </thead> <tbody> <tr> <td> <p>W: 18 H: 22 D: 24,29</p> <p>Meets ADA Requirements for Adult Sizing Full Enclosure Design Hinged, Locked, Laminate Faced Access Panel Compatible with 10888/10889 Trash Grommets and 10905/10907 10-gallon Trash Bins (see Accessories)</p> </td> <td> <p>W: 18 H: 18 D: 24,29</p> <p>Meets ADA Requirements for Child Sizing Full Enclosure Design Hinged, Locked, Laminate Faced Access Panel Compatible with 10888/10889 Trash Grommets and 10904/10906 7-gallon Trash Bins (see Accessories)</p> </td> </tr> <tr> <td>10600</td> <td>10601</td> </tr> <tr> <td> <p>22H</p>  </td> <td> <p>18H</p>  </td> </tr> </tbody> </table>	ADA Wall Trash Module – Adult Size	ADA Wall Trash Module – Child Size	<p>W: 18 H: 22 D: 24,29</p> <p>Meets ADA Requirements for Adult Sizing Full Enclosure Design Hinged, Locked, Laminate Faced Access Panel Compatible with 10888/10889 Trash Grommets and 10905/10907 10-gallon Trash Bins (see Accessories)</p>	<p>W: 18 H: 18 D: 24,29</p> <p>Meets ADA Requirements for Child Sizing Full Enclosure Design Hinged, Locked, Laminate Faced Access Panel Compatible with 10888/10889 Trash Grommets and 10904/10906 7-gallon Trash Bins (see Accessories)</p>	10600	10601	<p>22H</p> 	<p>18H</p> 
ADA Wall Trash Module – Adult Size	ADA Wall Trash Module – Child Size								
<p>W: 18 H: 22 D: 24,29</p> <p>Meets ADA Requirements for Adult Sizing Full Enclosure Design Hinged, Locked, Laminate Faced Access Panel Compatible with 10888/10889 Trash Grommets and 10905/10907 10-gallon Trash Bins (see Accessories)</p>	<p>W: 18 H: 18 D: 24,29</p> <p>Meets ADA Requirements for Child Sizing Full Enclosure Design Hinged, Locked, Laminate Faced Access Panel Compatible with 10888/10889 Trash Grommets and 10904/10906 7-gallon Trash Bins (see Accessories)</p>								
10600	10601								
<p>22H</p> 	<p>18H</p> 								

BASE

Specialty





Specialty							
Microwave							
	<p>W: 27,30 H: 32,35 D: 24</p> <p>Accommodates 1 cu.ft. - 2 cu.ft. Freestanding Microwave Microwave Compt. Height=15½" Lower Open Storage</p>	<p>W: 27,30 H: 32,35 D: 24</p> <p>Accommodates 1 cu.ft. - 2 cu.ft. Freestanding Microwave Microwave Compt. Height=15½" Drawer</p>	<p>W: 27,30 H: 32,35 D: 24</p> <p>Accommodates 1 cu.ft. - 2 cu.ft. Freestanding Microwave Microwave Compt. Height=15½" Lower Storage with Doors</p>	<p>W: 30,33 H: 32,35 D: 24</p> <p>Accommodates 1.6 cu.ft. - 1.7 cu.ft. Built-in Microwave Microwave Compt. Height=19¾" Lower Open Storage</p>	<p>W: 30,33 H: 32,35 D: 24</p> <p>Accommodates 1.6 cu.ft. - 1.7 cu.ft. Built-in Microwave Microwave Compt. Height=19¾" Drawer</p>	<p>W: 30,33 H: 35 D: 24</p> <p>Accommodates 1.6 cu.ft. - 1.7 cu.ft. Built-in Microwave Microwave Compt. Height=19¾" Lower Storage with Doors</p>	
	10726	10728	10730	10727	10729	10731	
32H 35H							

Specialty	
Poster/Chart Rack	
<p>W: 48 H: 35 D: 24</p> <p>Rollout Rack with 10 Rails for Hanging Posters and Charts Maximum Poster/Chart Size=40"W x 28"H</p>	<p>W: 48 H: 35 D: 24</p> <p>Doors Rollout Rack with 10 Rails for Hanging Posters and Charts Maximum Poster/Chart Size=40"W x 28"H</p>
10670	10671

Half-Depth Shelf

Storage compartments have half-depth shelving to allow large storage up front.

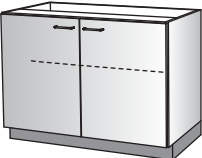
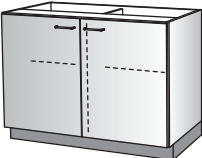
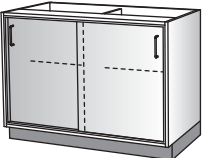
Half-Depth Shelf						
Shelf						
	<p>W: 12,15,18,21,24 H: 29,32,35 D: 21,24,29</p> <p>Right Hinge Door Half-Depth Adjustable Shelf Optional Removable Back</p>	<p>W: 12,15,18,21,24 H: 29,32,35 D: 21,24,29</p> <p>Left Hinge Door Half-Depth Adjustable Shelf Optional Removable Back</p>	<p>W: 24,27,30,33,36,39,42,45,48 H: 29,32,35 D: 21,24,29</p> <p>Doors Half-Depth Adjustable Shelf Optional Removable Back</p>	<p>W: 39,42,45,48 H: 29,32,35 D: 21,24,29</p> <p>Doors Center Divider Half-Depth Adjustable Shelves</p>	<p>W: 30,33,36,39,42,45,48 H: 29,32,35 D: 21,24,29</p> <p>Sliding Doors Center Divider Half-Depth Adjustable Shelves</p>	
	10118	10119	10130	10182	10149	
<p>29H 32H 35H</p>						

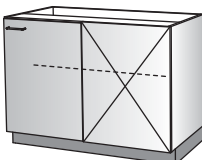
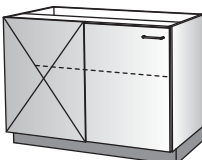
Half-Depth Shelf	
Corner – Blind	
<p>21" DEEP: W: 36,39,42 H: 29,32,35,41 D: 21</p> <p>24" DEEP: W: 42,45,48 H: 29,32,35,41 D: 24</p> <p>Right Hinge Door Half-Depth Adjustable Shelf</p>	<p>21" DEEP: W: 36,39,42 H: 29,32,35,41 D: 21</p> <p>24" DEEP: W: 42,45,48 H: 29,32,35,41 D: 24</p> <p>Left Hinge Door Half-Depth Adjustable Shelf</p>
10196	10197
	

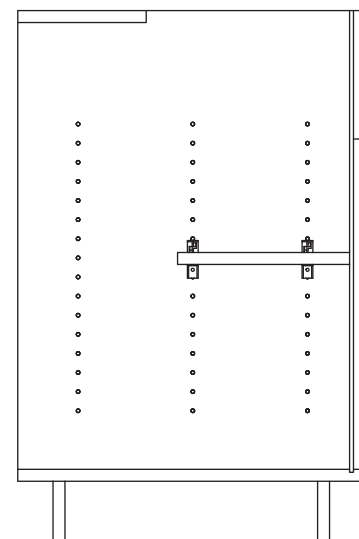

Half-depth shelf detail

BASE

Half-Depth Shelf

Storage compartments have half-depth shelving to allow large storage up front.









Half-Depth Shelf					
Combination Storage					
	<p>W: 30,33,36,39,42,45,48 H: 29,32,35 D: 21,24,29</p> <p>3 Equal Drawers Right Hinge Door Half-Depth Adjustable Shelf</p>	<p>W: 30,33,36,39,42,45,48 H: 29,32,35 D: 21,24,29</p> <p>3 Equal Drawers Left Hinge Door Half-Depth Adjustable Shelf</p>	<p>W: 30,33,36,39,42,45,48 H: 29,32,35 D: 21,24,29</p> <p>4 Equal Drawers Right Hinge Door Half-Depth Adjustable Shelf</p>	<p>W: 30,33,36,39,42,45,48 H: 29,32,35 D: 21,24,29</p> <p>4 Equal Drawers Left Hinge Door Half-Depth Adjustable Shelf</p>	
	10337	10338	10759	10760	
<p>29H 32H 35H</p>					

Half-Depth Shelf					
Combination Storage					
	<p>W: 30,33,36,39,42,45,48 H: 32,35 D: 21,24,29</p> <p>4 Equal Drawers Right Hinge Door Half-Depth Adjustable Shelf</p>	<p>W: 30,33,36,39,42,45,48 H: 32,35 D: 21,24,29</p> <p>4 Equal Drawers Left Hinge Door Half-Depth Adjustable Shelf</p>	<p>W: 30,33,36,39,42,45,48 H: 32,35 D: 21,24,29</p> <p>5 Equal Drawers Right Hinge Door Half-Depth Adjustable Shelf</p>	<p>W: 30,33,36,39,42,45,48 H: 32,35 D: 21,24,29</p> <p>5 Equal Drawers Left Hinge Door Half-Depth Adjustable Shelf</p>	
	10755	10756	10763	10764	
<p>32H 35H</p>					

Half-Depth Shelf

Storage compartments have half-depth shelving to allow large storage up front.

Half-Depth Shelf						
Combination Storage						
	<p>W: 15,18,21,24 H: 32,35 D: 21,24,29</p> <p>2 Equal Drawers Right Hinge Door Half-Depth Adjustable Shelf</p>	<p>W: 15,18,21,24 H: 32,35 D: 21,24,29</p> <p>2 Equal Drawers Left Hinge Door Half-Depth Adjustable Shelf</p>	<p>W: 24,27,30,33,36 H: 32,35 D: 21,24,29</p> <p>2 Equal Drawers Doors Half-Depth Adjustable Shelf</p>	<p>W: 39,42,45,48 H: 32,35 D: 21,24,29</p> <p>2 Equal Drawers Doors Half-Depth Adjustable Shelf</p>	<p>W: 30,33,36,39,42,45,48 H: 32,35 D: 21,24,29</p> <p>4 Equal Drawers Doors Center Divider Half-Depth Adjustable Shelves</p>	
	10739	10740	10747	10767	10749	
32H 35H						

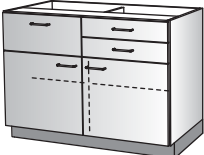
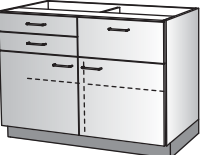
Half-Depth Shelf						
Combination Storage						
	<p>W: 30,33,36,39,42,45,48 H: 32,35 D: 21,24,29</p> <p>4 Equal Drawers 2 Equal Deep Drawers Right Hinge Door Half-Depth Adjustable Shelf</p>	<p>W: 30,33,36,39,42,45,48 H: 32,35 D: 21,24,29</p> <p>4 Equal Drawers 2 Equal Deep Drawers Left Hinge Door Half-Depth Adjustable Shelf</p>	<p>W: 30,33,36,39,42,45,48 H: 32,35 D: 21,24,29</p> <p>Left: Deep Drawer Right: 2 Equal Drawers Doors Center Divider Half-Depth Adjustable Shelves</p>	<p>W: 30,33,36,39,42,45,48 H: 32,35 D: 21,24,29</p> <p>Left: 2 Equal Drawers Right: Deep Drawer Doors Center Divider Half-Depth Adjustable Shelves</p>		
	10743	10744	10751	10753		
32H 35H						

BASE

Installation Accessories

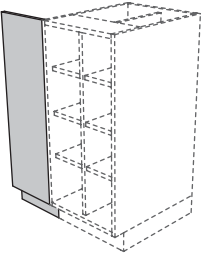
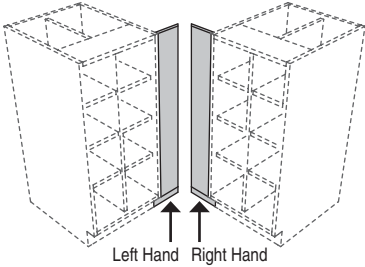

Vertical Scribe	Front Filler	Corner Filler
<p>W: 00 H: 24,29,32,35,41,54 D: 14,18,21,24,29</p> <p>Field Trim to Fit Actual Thickness=3/4" Actual Depth=3" Edgebanding: One Long Edge in Casebody Trim Color and Thickness</p>	<p>W: 02,03,06,09,12 H: 24,29,32,35,41,54 D: 14,18,21,24,29</p> <p>Field Trim to Fit Edgebanding: None</p>	<p>W: 02,03,06,09,12 H: 24,29,32,35,41,54 D: 14,18,21,24,29</p> <p>Field Trim to Fit Depths (D) Listed are Depths of Cabinets to which Filler is Attached Edgebanding: None</p>
10802	10803	10805
		

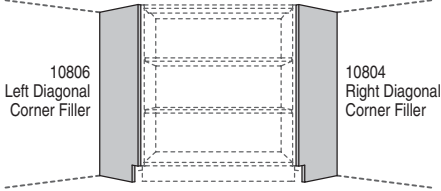
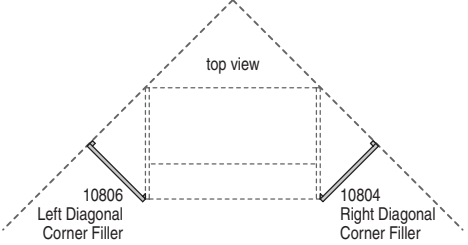
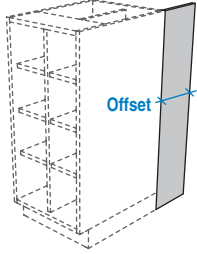
Diagonal Corner Filler (right)	Diagonal Corner Filler (left)	Side Filler
<p>W: 00 H: 24,29,32,35,41,54 D: 14,18,21,24,29</p> <p>Depths (D) Listed are Depths of Cabinets to which Filler is Attached Edgebanding: One Long Edge in Casebody Trim Color and 0.5mm Thickness</p>	<p>W: 00 H: 24,29,32,35,41,54 D: 14,18,21,24,29</p> <p>Depths (D) Listed are Depths of Cabinets to which Filler is Attached Edgebanding: One Long Edge in Casebody Trim Color and 0.5mm Thickness</p>	<p>W: 00 H: 24,29,32,35,41,54 D: 04,06,08,12,15</p> <p>Field Trim to Fit Edgebanding: One Long Edge in Casebody Trim Color and Thickness</p>
10804	10806	10807
		

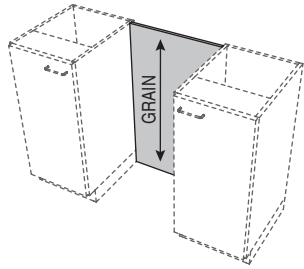
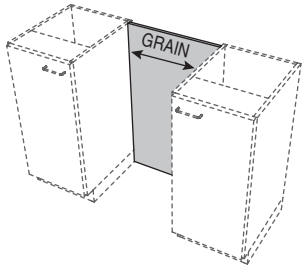
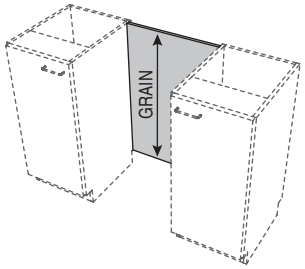
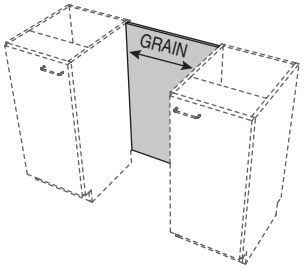
Modesty Panel – full height (finished one side)		Modesty Panel – above kick (finished one side)	
<p>Vertical Grain</p> <p>W: 24,30,36,42,48 H: 24,29,32,35,41 D: 00</p> <p>Finished on One Side Full Height Order by Cabinet Height Edgebanding: None</p> <p>10809</p> 	<p>Horizontal Grain</p> <p>W: 24,30,36,42,48 H: 24,29,32,35,41 D: 00</p> <p>Finished on One Side Full Height Order by Cabinet Height Edgebanding: None</p> <p>10864</p> 	<p>Vertical Grain</p> <p>W: 24,30,36,42,48 H: 24,29,32,35,41 D: 00</p> <p>Finished on One Side Bottom Edge Aligns with Toe Kick Order by Cabinet Height Edgebanding: None</p> <p>10865</p> 	<p>Horizontal Grain</p> <p>W: 24,30,36,42,48 H: 24,29,32,35,41 D: 00</p> <p>Finished on One Side Bottom Edge Aligns with Toe Kick Order by Cabinet Height Edgebanding: None</p> <p>10866</p> 

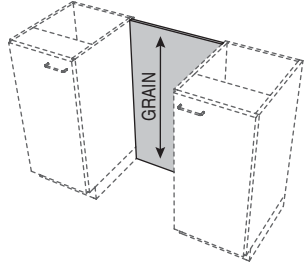
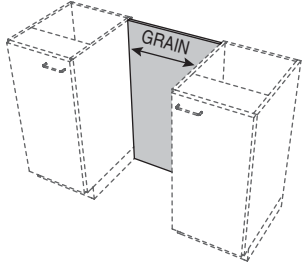
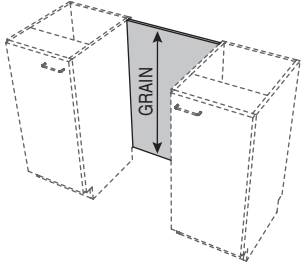
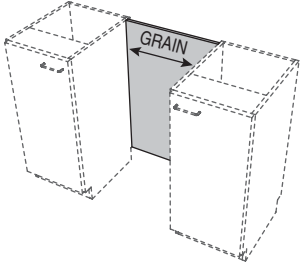
Modesty Panel – full height (finished both sides)		Modesty Panel – above kick (finished both sides)	
<p>Vertical Grain</p> <p>W: 24,30,36,42,48 H: 24,29,32,35,41 D: 00</p> <p>Finished on Both Sides Full Height Order by Cabinet Height Edgebanding: None</p> <p>10950</p> 	<p>Horizontal Grain</p> <p>W: 24,30,36,42,48 H: 24,29,32,35,41 D: 00</p> <p>Finished on Both Sides Full Height Order by Cabinet Height Edgebanding: None</p> <p>10951</p> 	<p>Vertical Grain</p> <p>W: 24,30,36,42,48 H: 24,29,32,35,41 D: 00</p> <p>Finished on Both Sides Bottom Edge Aligns with Toe Kick Order by Cabinet Height Edgebanding: None</p> <p>10952</p> 	<p>Horizontal Grain</p> <p>W: 24,30,36,42,48 H: 24,29,32,35,41 D: 00</p> <p>Finished on Both Sides Bottom Edge Aligns with Toe Kick Order by Cabinet Height Edgebanding: None</p> <p>10953</p> 

BASE

Installation Accessories



Overlay Back – full height (finished one side)		Overlay Back – above kick (finished one side)	
Vertical Grain W: 12,15,18,21,24,27,30,33,36, 39,42,45,48 H: 24,29,32,35,41 D: 00 Finished on One Side Full Height Order by Cabinet Height Edgebanding: All Edges in Casebody Trim Color and Thickness	Horizontal Grain W: 36,42,48,60,72,84,96 H: 24,29,32,35,41 D: 00 Finished on One Side Full Height Order by Cabinet Height Edgebanding: All Edges in Casebody Trim Color and Thickness	Vertical Grain W: 12,15,18,21,24,27,30,33,36, 39,42,45,48 H: 24,29,32,35,41 D: 00 Finished on One Side Bottom Edge Aligns with Toe Kick Order by Cabinet Height Edgebanding: All Edges in Casebody Trim Color and Thickness	Horizontal Grain W: 36,42,48,60,72,84,96 H: 24,29,32,35,41 D: 00 Finished on One Side Bottom Edge Aligns with Toe Kick Order by Cabinet Height Edgebanding: All Edges in Casebody Trim Color and Thickness
10811	10810	10868	10867

Overlay Back – full height (finished both sides)		Overlay Back – above kick (finished both sides)	
Vertical Grain W: 12,15,18,21,24,27,30,33,36, 39,42,45,48 H: 24,29,32,35,41 D: 00 Finished on Both Sides Full Height Order by Cabinet Height Edgebanding: All Edges in Casebody Trim Color and Thickness	Horizontal Grain W: 36,42,48,60,72,84,96 H: 24,29,32,35,41 D: 00 Finished on Both Sides Full Height Order by Cabinet Height Edgebanding: All Edges in Casebody Trim Color and Thickness	Vertical Grain W: 12,15,18,21,24,27,30,33,36, 39,42,45,48 H: 24,29,32,35,41 D: 00 Finished on Both Sides Bottom Edge Aligns with Toe Kick Order by Cabinet Height Edgebanding: All Edges in Casebody Trim Color and Thickness	Horizontal Grain W: 36,42,48,60,72,84,96 H: 24,29,32,35,41 D: 00 Finished on Both Sides Bottom Edge Aligns with Toe Kick Order by Cabinet Height Edgebanding: All Edges in Casebody Trim Color and Thickness
10954	10955	10956	10957

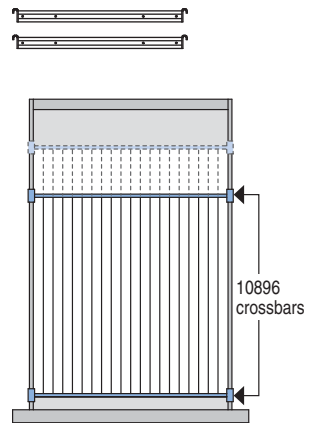
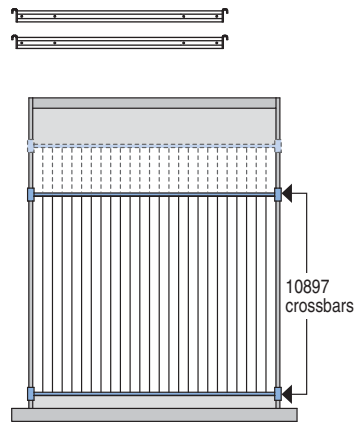
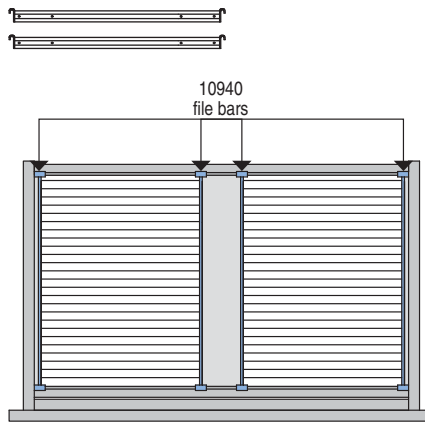
File Crossbars	File Crossbars	File Bars
<p>W: 15 H: 01 D: 00</p> <p>Pair of Crossbars for 15W File Drawers (Letter) Allow Side Filing</p>	<p>W: 18 H: 01 D: 00</p> <p>Pair of Crossbars for 18W File Drawers (Legal) Allow Side Filing</p>	<p>W: 00 H: 01 D: 18</p> <p>1 Pair of File Bars for Lateral File Drawers Allow Front-to-Back Filing 1 Pair Required for 24W-27W Lateral File Drawers 2 Pairs Required for 30W-42W Lateral File Drawers</p>
10896	10897	10940
 <p>Letter File Drawer with optional crossbars installed for side filing</p>	 <p>Legal File Drawer with optional crossbars installed for side filing</p>	 <p>Lateral File Drawer with two pairs of optional file bars installed for front-to-back filing</p>

ATTACHED TOE KICK

For a finished look on an open bottom cabinet with doors, an Attached Toekick is offered on some units. The toekick is black and can have vinyl base applied directly to it.

