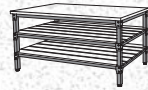

Table of Contents



Steel Frame Bench 3



Workbench 4-5



Island Locker Bench 6-7



Pedestal Bench Table 8



Specialty Project Workstation 9



Crafts Table 10



Steel Frame Bench Table 11

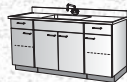

Wall Craft Sink 12



Island Craft Sink 13

(continued on page 2)

Table of Contents *(continued)*



Specialty Sink 14



Spray Booth/Hood 15



Paper Storage 16



Stackable Storage 17



Project Storage 18-20



Drafting Board Storage 21



Crafts/Specialty Storage 22



Material Storage 23-24



Accessories 25

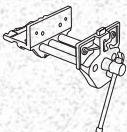

Vises 26

Steel Frame Bench

See Countertop section for available top series.

Multi-Purpose Bench

SUGGESTED TOP SERIES	
Series	Description
WD00S44	1¾" Hardwood (Maple)

W	H	D
72	34	42
78		48

Powder Coated Welded Upper and Lower Frames
Bolted 2x2 Tubular Legs
Lower Frame with 1" Deck Slats
Top Space Overhang on Ends Accommodates
Woodworking Vises (see page 26)

35701

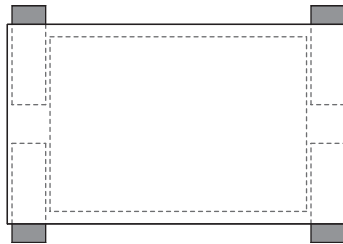

72W Bench:
overhang accommodates up to
4x7 Woodworking Vises

78W Bench:
overhang accommodates up to
4x9 and 4x10 Woodworking Vises

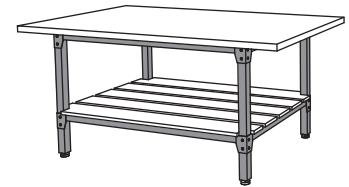

Metalworking Bench

SUGGESTED TOP SERIES	
Series	Description
WD00S44	1¾" Hardwood (Maple)

W	H	D
72	34	42
96		96

Powder Coated Welded Upper and Lower Frames
Bolted 2x2 Tubular Legs
Lower Frames with 1" Deck Slats
Top Includes Front and Back Full Length Angle Iron Edge
Accommodates Top Mounted Vises (see page 26)

35702

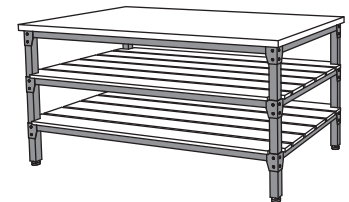

ARTS AND CRAFTS

Workbench

See Countertop section for available top series.



	W	H	D
30" Chair Height	95	50	24
34" Stool / ADA Height	95	54	24

Accommodates 35610 Electronics Bar
(see next page)

	W	H	D
30" Chair Height	95	50	24
34" Stool / ADA Height	95	54	24

Accommodates 35610 Electronics Bar
(see next page)

	W	H	D
30" Chair Height	95	50	24
34" Stool / ADA Height	95	54	24

Accommodates 35610 Electronics Bar
(see next page)

35730

35732

35733

50H
30"
Chair Height

54H
34"
Stool / ADA
Height

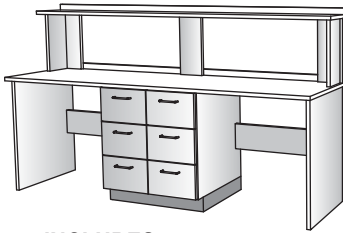

INCLUDES:

	W	H	D
(1) 10344	30	29	24
		32	

6 Equal Drawers

- (1) 35611 Hutch Assembly
- (2) 10812 Pedestal Legs
- (2) 10870 Apron Rails

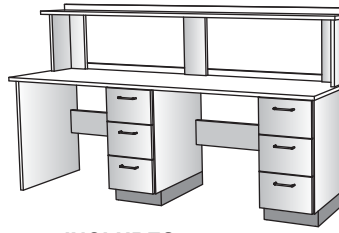

INCLUDES:

	W	H	D
(2) 10332	15	29	24
		32	

3 Equal Drawers

- (1) 35611 Hutch Assembly
- (2) 10812 Pedestal Legs
- (2) 10870 Apron Rails

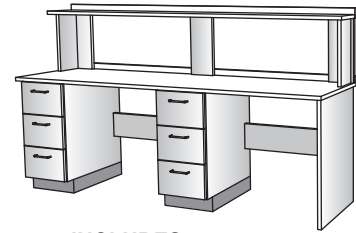

INCLUDES:

	W	H	D
(2) 10332	15	29	24
		32	

3 Equal Drawers

- (1) 35611 Hutch Assembly
- (2) 10812 Pedestal Legs
- (2) 10870 Apron Rails

	W	H	D
30" Chair Height	95	50	24
34" Stool / ADA Height	95	54	24

Accommodates 35610 Electronics Bar
(see next page)

	W	H	D
30" Chair Height	95	50	24
34" Stool / ADA Height	95	54	24

Accommodates 35610 Electronics Bar
(see next page)

	W	H	D
30" Chair Height	95	50	24
34" Stool / ADA Height	95	54	24

Accommodates 35610 Electronics Bar
(see next page)

35731

35736

35737

50H
30"
Chair Height

54H
34"
Stool / ADA
Height

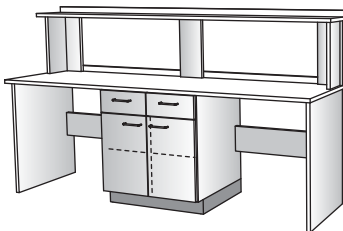

INCLUDES:

	W	H	D
(1) 10441	30	29	24
		32	

2 Drawers: 6 1/8"H False Front
Doors
Center Divider
Adjustable Shelves

- (1) 35611 Hutch Assembly
- (2) 10812 Pedestal Legs
- (2) 10870 Apron Rails

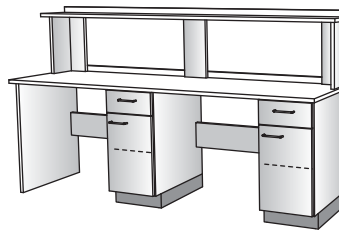

INCLUDES:

	W	H	D
(2) 10421	15	29	24
		32	

Drawer: 6 1/8"H False Front
Right Hinge Door
Adjustable Shelf

- (1) 35611 Hutch Assembly
- (2) 10812 Pedestal Legs
- (2) 10870 Apron Rails

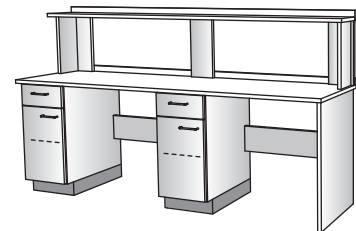

INCLUDES:

	W	H	D
(2) 10422	15	29	24
		32	

Drawer: 6 1/8"H False Front
Left Hinge Door
Adjustable Shelf

- (1) 35611 Hutch Assembly
- (2) 10812 Pedestal Legs
- (2) 10870 Apron Rails

See Countertop section for available top series.

	W	H	D
30" Chair Height	72	50	24
34" Stool / ADA Height	72	54	24

Accommodates 35610 Electronics Bar
(see below)

35734

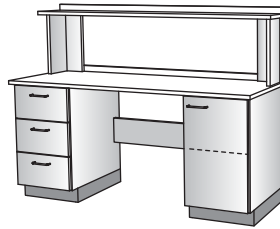

INCLUDES:

	W	H	D
(1) 10332	18	29	24
		32	

3 Equal Drawers

	W	H	D
(1) 10120	18	29	24
		32	

Right Hinge Door
Adjustable Shelf

- (1) 35611 Hutch Assembly
- (1) 10870 Apron Rail

	W	H	D
30" Chair Height	72	50	24
34" Stool / ADA Height	72	54	24

Accommodates 35610 Electronics Bar
(see below)

35735

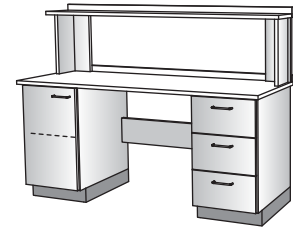

INCLUDES:

	W	H	D
(1) 10121	18	29	24
		32	

Left Hinge Door
Adjustable Shelf

	W	H	D
(1) 10332	18	29	24
		32	

3 Equal Drawers

- (1) 35611 Hutch Assembly
- (1) 10870 Apron Rail

50H
30"
Chair Height

54H
34"
Stool / ADA
Height

Electronics Bar

W	H	D
72	04	02

- 110V 1PH 15AMP Strip
- (1) Switch
- (1) GFI Receptacle
- (5) Single Receptacles
- Grounded Power Cord
- For 72W Workbenches

W	H	D
95	04	02

- 110V 1PH 15AMP Strip
- (1) Switch
- (1) GFI Receptacle
- (7) Single Receptacles
- Grounded Power Cord
- For 95W Workbenches

35610



35734 Workbench with
35610 Electronics Bar

35610

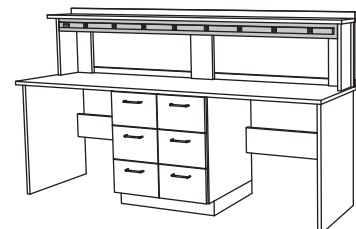

35730 Workbench with
35610 Electronics Bar

ARTS AND CRAFTS

Island Locker Bench – Single Face

See Countertop section for available top series.



SUGGESTED TOP SERIES	
Series	Description
WD00S44	1¾" Hardwood (Maple) (recommended for use with vises)
BW00C38	1½" Workbench (MDF)

W H D
36 35 24

Single Face Island
3 Lockers: 11W x 29½H x 19¾D
Individual Self Latching Padlock Hasps for
Padlocks by Others
Top Ordered Separately

W H D
36 35 24

Single Face Island
6 Lockers: 11W x 14¾H x 19¾D
Individual Self Latching Padlock Hasps for
Padlocks by Others
Top Ordered Separately

W H D
36 35 24

Single Face Island
2 Lockers: 167⁄8W x 29½H x 19¾D
Individual Self Latching Padlock Hasps for
Padlocks by Others
Top Ordered Separately

35740

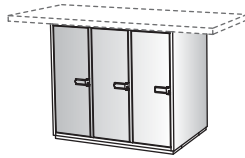

35741

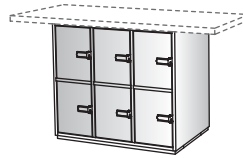

35742

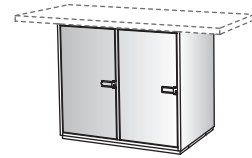

W H D
36 35 24

Single Face Island
4 Lockers: 167⁄8W x 14¾H x 19¾D
Individual Self Latching Padlock
Hasps for Padlocks by Others
Top Ordered Separately

W H D
36 35 24

Single Face Island
Storage Base: 34½W x 29½H x 19¾D
Adjustable Shelf
Self Latching Padlock Hasp
for Padlock by Others
Top Ordered Separately

35743

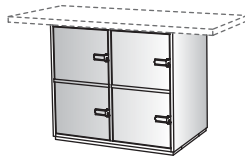

35744

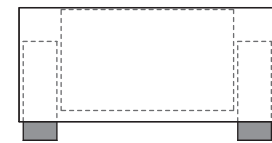
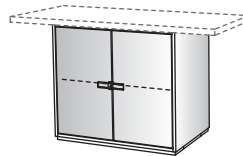

With 54" wide top,
overhang can accommodate up to
4x7 Woodworking Visas
(see page 26)

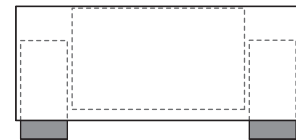

With 60" wide top,
overhang can accommodate up to
4x9 and 4x10 Woodworking Visas
(see page 26)

Island Locker Bench – Double Face

See Countertop section for available top series.

SUGGESTED TOP SERIES	
Series	Description
WD00S44	1¾" Hardwood (Maple) (recommended for use with vises)
BW00C38	1½" Workbench (MDF)

W H D
36 35 48

Double Face Island
3 Lockers (each face):
11W x 29½H x 19¾D
Individual Self Latching Padlock Hasps for
Padlocks by Others
Top Ordered Separately

35750

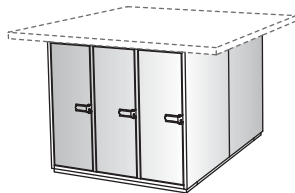

W H D
36 35 48

Double Face Island
6 Lockers (each face):
11W x 14¾H x 19¾D
Individual Self Latching Padlock Hasps for
Padlocks by Others
Top Ordered Separately

35751

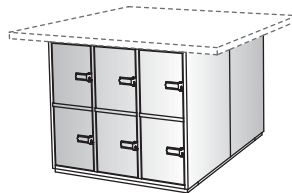

W H D
36 35 48

Double Face Island
2 Lockers (each face):
16⅞W x 29½H x 19¾D
Individual Self Latching Padlock
Hasps for Padlocks by Others
Top Ordered Separately

35752

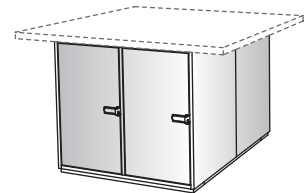

W H D
36 35 48

Double Face Island
4 Lockers (each face):
16⅞W x 14¾H x 19¾D
Individual Self Latching Padlock
Hasps for Padlocks by Others
Top Ordered Separately

35753

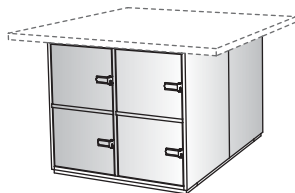

W H D
36 35 48

Double Face Island
Storage Base (each face):
34½W x 29½H x 19¾D
Self Latching Padlock Hasps
for Padlocks by Others
Top Ordered Separately

35754

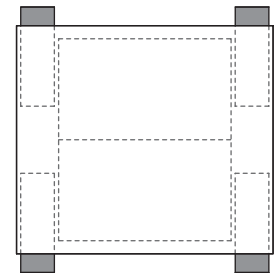
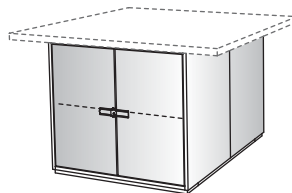

With 54" wide top, overhang can accommodate
up to 4x7 Woodworking Vises
(see page 26)

With 60" wide top, overhang can accommodate
up to 4x9 and 4x10 Woodworking Vises
(see page 26)

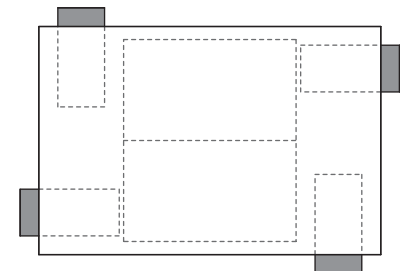

With 72" wide top, overhang can accommodate
alternate corner mounting of 4x7
and up to 4x9 and 4x10 Woodworking Vises
(see page 26)

ARTS AND CRAFTS

Pedestal Bench Table

See Countertop section for available top series.



SUGGESTED TOP SERIES	
Series	Description
	GENERAL USE:
LS05_27	1 1/16" High Pressure Laminate with 3mm Edge
	HEAVY DUTY:
LS05_40	1 9/16" High Pressure Laminate with 3mm Edge
	WORKBENCH:
WD00S44	1 3/4" Hardwood (Maple) (recommended for use with vises)

W H D
60 30 40

Heavy Bolted Hardwood Plycore Construction
Clear Coat Finish
Black Powder Coated Tubular Foot Base with Levelers
60"x40" Top
(laminated tops have black edges)

W H D
60 30 40

Heavy Bolted Hardwood Plycore Construction
Clear Coat Finish
Black Powder Coated Tubular Foot Base with Levelers
Under Counter Double Face Book Boxes
60"x40" Top
(laminated tops have black edges)

W H D
60 30 40

Heavy Bolted Hardwood Plycore Construction
Clear Coat Finish
Black Powder Coated Tubular Foot Base with Levelers
(4) SA901 Trays on Rails (2 per side)
60"x40" Top
(laminated tops have black edges)

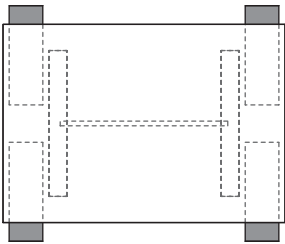

Pedestal Bench Tables:
overhang accommodates up to
4x7 Woodworking Vises
(see page 26)

35900

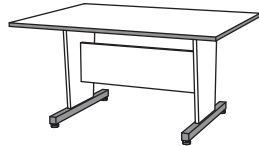

35902

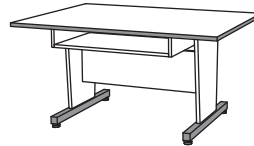

35904

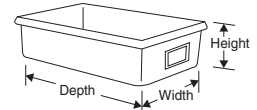

Molded trays with card holder:
SA901: 14 1/4W x 3 1/2H x 19D

Wall Counter Assembly

SUGGESTED TOP SERIES	
Series	Description
LS05_27	1 1/16" High Pressure Laminate with 3mm Edge
PS59_29	1 1/8" Solid Surface with 3R/3R Profile Edge
WD00S44	1 3/4" Hardwood (Maple)



W	H	D
72	36	19
84		22
96		25

Depths Refer to Nominal Top Sizes

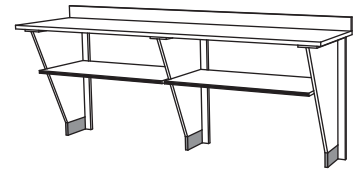
35940



INCLUDES:

 (3) 10916	W	H	D
	00	35	18
			21
			24
	One each: left finished end, right finished end, centered		
 (2) 10973	W	H	D
	33	00	14
			39
			45
	Includes Brackets		

Wedging Table

W	H	D
48	59	26

(2) SA901 Trays
3/4" High Density Poly Surfaces and Back Panel
Stainless Steel Wedging Wire
Black Powder Coated Steel Frame Construction

35941

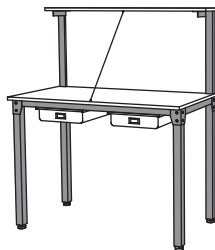

Molded trays with card holder:
SA901: 14 1/4W x 3 1/2H x 19D

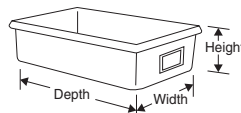

Jewelry Station

W	H	D
59	54	23

(2) SA901 Trays
Black Phenolic Work Surface
White Laminate Structure
Black Powder Coated Steel Frame Construction

35942

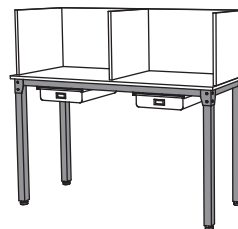

Enlarger Station

W	H	D
36	59	29

Black Laminated Finishes
Adjustable Platform on Side Rails

35943

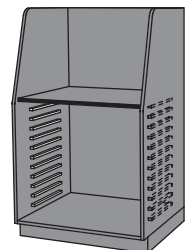

ARTS AND CRAFTS

Crafts Table

See Countertop section for available top series.



SUGGESTED TOP SERIES	
Series	Description
LS05_27	1 1/16" High Pressure Laminate with 3mm Edge
PS59_29	1 1/8" Solid Surface with 3R/3R Profile Edge
WD00S44	1 3/4" Hardwood (Maple)

Round Crafts Table

W	H	D
42	30	42
	34	
48	30	48
	34	

Powder Coated 2x2
Steel Tubular Legs
Adjustable Leveling Glides
Laminate Plycore Frame Rails
34H = ADA Height

38890



Square Crafts Table

W	H	D
42	30	42
	34	
48	30	48
	34	

Powder Coated 2x2
Steel Tubular Legs
Adjustable Leveling Glides
Laminate Plycore Frame Rails
34H = ADA Height

38892

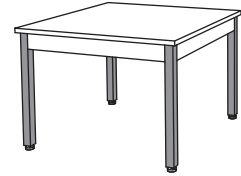

Rectangle Crafts Table

W	H	D
36	60	30
42	66	34
48	72	
54		

Powder Coated 2x2
Steel Tubular Legs
Adjustable Leveling Glides
Laminate Plycore Frame Rails
34H = ADA Height

38860

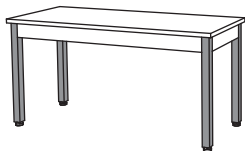

W	H	D
36	60	30
42	66	34
48	72	
54		

Powder Coated 2x2
Steel Tubular Legs
Adjustable Leveling Glides
Laminate Plycore Frame Rails
34H = ADA Height

38868

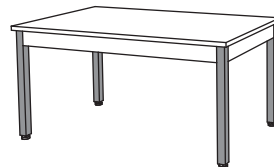

W	H	D
48	66	30
54	72	34
60		48

Powder Coated 2x2
Steel Tubular Legs
Adjustable Leveling Glides
Laminate Plycore Frame Rails
34H = ADA Height

38876

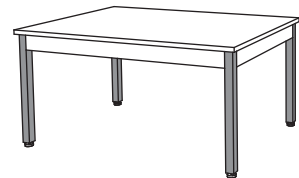



ARTS AND CRAFTS

Steel Frame Bench Table

See Countertop section for available top series.

SUGGESTED TOP SERIES	
Series	Description
LS05_27	1 1/16" High Pressure Laminate with 3mm Edge
PS59_29	1 1/8" Solid Surface with 3R/3R Profile Edge
WD00S44	1 3/4" Hardwood (Maple) (required for use with vises)

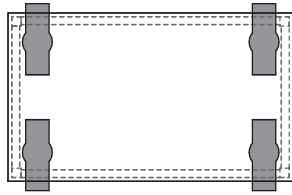

Steel Frame Bench Tables: accommodate top mounted Bench Vises and Multi-Purpose Vises (see page 26)
(WD00S44 1 3/4" Hardwood top required)

For Steel Frame Bench Table and Extension Table combinations, tops provided in one-piece lengths up to maximum of:

- 143 1/2" High Pressure Laminate
- 119 1/2" Solid Surface
- 143 1/2" Hardwood (Maple)

Steel Frame Bench Table

W	H	D
36	30	30
42	34	36
48		
54		
60		
66		
72		

Powder Coated, Heavy Welded Steel Frame Assembly
Bolted 2x2 Tubular Legs
Adjustable Leveling Glides
34H = ADA Height

38768



W	H	D
48	30	42
54	34	48
60		
66		
72		

Powder Coated, Heavy Welded Steel Frame Assembly
Bolted 2x2 Tubular Legs
Adjustable Leveling Glides
34H = ADA Height

38776



Steel Frame Bench Extension Table

W	H	D
35	30	30
41	34	36
47		
53		
59		
65		
71		

Powder Coated, Heavy Welded Steel Frame Assembly
Bolted 2x2 Tubular Legs
Adjustable Leveling Glides
34H = ADA Height

38772

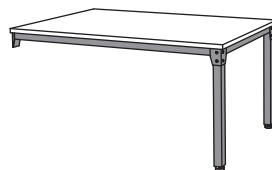

W	H	D
47	30	42
53	34	48
59		
65		
71		

Powder Coated, Heavy Welded Steel Frame Assembly
Bolted 2x2 Tubular Legs
Adjustable Leveling Glides
34H = ADA Height

38780



ARTS AND CRAFTS

Wall Craft Sink

Compatible with 52P97 Plaster and Sediment Trap



W	H	D
56	40	25
62		

16 Gauge Stainless Steel Marine Edge Top (36" Counter Height)
Integral Backsplash
(1) Integral 16" x 28" x 10 1/2" Sink
(1) 52248-9A Deck Mount Hot and Cold Mixing Faucet
(1) 52J35 Strainer

35300

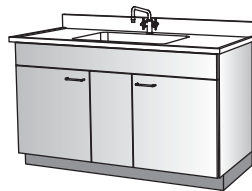

INCLUDES:

	W	H	D
(1) 10480	54	35	24
	60		

6 1/8" H False Front
Doors
Removable Backs

W	H	D
56	42	30
62		

16 Gauge Stainless Steel Marine Edge Top (36" Counter Height)
Integral High Back Wall Mount
Integral 18" x 40" x 8" Sink
(2) 52269-6A Cold Water Faucets
(1) 52276-8A Hot and Cold Faucet
(1) 52J35 Strainer

35302

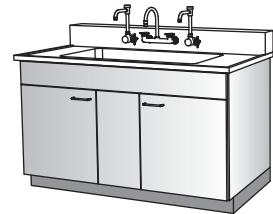

INCLUDES:

	W	H	D
(1) 10480	54	35	29
	60		

6 1/8" H False Front
Doors
Removable Backs

W	H	D
74	40	25

16 Gauge Stainless Steel Marine Edge Top (36" Counter Height)
Integral Backsplash
(1) Integral 16" x 28" x 10 1/2" Sink
(1) 52248-9A Deck Mount Hot and Cold Mixing Faucet
(1) 52J35 Strainer

35301

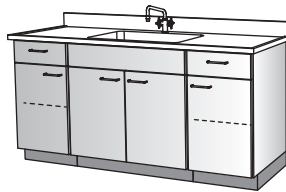

INCLUDES:

	W	H	D
(1) 10422	18	35	24

Drawer: 6 1/8" H Front
Left Hinge Door
Adjustable Shelf

	W	H	D
(1) 10479	36	35	24

6 1/8" H False Front
Doors
Removable Back

	W	H	D
(1) 10421	18	35	24

Drawer: 6 1/8" H Front
Right Hinge Door
Adjustable Shelf

W	H	D
74	42	30

16 Gauge Stainless Steel Marine Edge Top (36" Counter Height)
Integral High Back Wall Mount
Integral 18" x 40" x 8" Sink
(2) 52269-6A Cold Water Faucets
(1) 52276-8A Hot and Cold Faucet
(1) 52J35 Strainer

35303

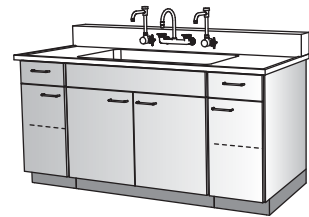

INCLUDES:

	W	H	D
(1) 10422	15	35	29

Drawer: 6 1/8" H Front
Left Hinge Door
Adjustable Shelf

	W	H	D
(1) 10479	42	35	29

6 1/8" H False Front
Doors
Removable Back

	W	H	D
(1) 10421	15	35	29

Drawer: 6 1/8" H Front
Right Hinge Door
Adjustable Shelf

W H D
50 36 49

16 Gauge Stainless Steel Marine Edge Top
(2) Integral 16" x 32" x 10½" Sinks
(2) 52248-9A Deck Mount Hot and Cold Mixing Faucets
(2) 52J35 Strainers

35320

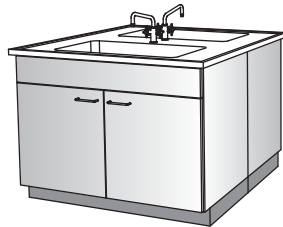

INCLUDES:



(2) 10479

W H D
48 35 24

6⅛"H False Front
Doors
Removable Back

W H D
56 36 49
62

16 Gauge Stainless Steel Marine Edge Top
(2) Integral 18" x 40" x 8" Sinks
(2) 52248-9A Deck Mount Hot and Cold Mixing Faucets
(2) 52J35 Strainers

35321

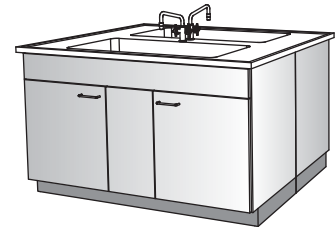

INCLUDES:



(2) 10480

W H D
54 35 24
60

6⅛"H False Front
Doors
Removable Backs

W H D
56 36 49
62

16 Gauge Stainless Steel Marine Edge Top
(2) Integral 18" x 40" x 8" Sinks
(2) 52248-9A Deck Mount Hot and Cold Mixing Faucets
(4) 52254-6A Deck Mount Cold Water Gooseneck Faucets
(2) 52J35 Strainers

35322

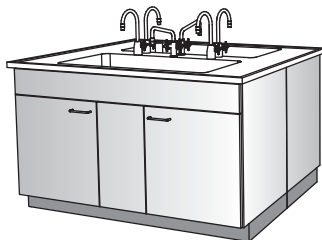

INCLUDES:



(2) 10480

W H D
54 35 24
60

6⅛"H False Front
Doors
Removable Backs

W H D
74 36 49

16 Gauge Stainless Steel Marine Edge Top
(2) Integral 18" x 40" x 8" Sinks
(2) 52248-9A Deck Mount Hot and Cold Mixing Faucets
(4) 52254-6A Deck Mount Cold Water Gooseneck Faucets
(2) 52J35 Strainers

35323

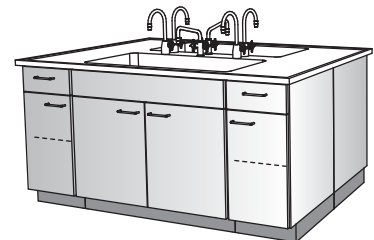

INCLUDES:



(2) 10422

W H D
15 35 24

Drawer: 6⅛"H Front
Left Hinge Door
Adjustable Shelf



(2) 10479

42 35 24
6⅛"H False Front
Doors
Removable Back



(2) 10421

15 35 24
Drawer: 6⅛"H Front
Right Hinge Door
Adjustable Shelf

ARTS AND CRAFTS

Specialty Sink



Island Rinse Away Center

W	H	D
86	55	25

16 Gauge Stainless Steel 10" Deep Trough Sink (36" High at Trough Rim)
Phenolic Apron Assembly and Ledge Shelf
Powder Coated Uprights and Faucet Chase
(6) Overhead Water Valves
(6) 522AR Aerators
(1) 52J35 Strainer

35340

INCLUDES:

- | | W | H | D |
|-----------------------------------|--------------------------------|----|----|
| (1) 35195 | 24 | 26 | 23 |
| Left Hinge Door Adjustable Shelf | | | |
| (1) 35194 | 24 | 26 | 23 |
| Right Hinge Door Adjustable Shelf | | | |
| (1) 91036 | Sink Apron Tub Assembly | | |
| (1) 91037 | Uprights/Faucet Chase Assembly | | |

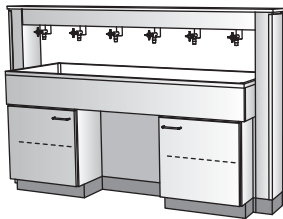

Rinse Away/Developing Center

W	H	D
74	42	25
81		

16 Gauge Stainless Steel Rinse Sink with 2" Rim Top Surface at 36" Height
Integral 14" x 14" x 7 1/2" Drain Sink
(1) 52262-6AWB Cold Water Faucet with Wrist Blade Handle
(1) Deck Mount Pre-Rinse Spray Unit
(1) 52J35 Strainer

35341

INCLUDES:

- | | W | H | D |
|---|----|----|----|
| (1) 35360 | 18 | 35 | 24 |
| 4 Equal Drawers | | | |
| (1) 35362 | 36 | 35 | 24 |
| 6 1/8" H False Front Doors Removable Back | | | |
| (1) 35361 | 18 | 35 | 24 |
| 21
4 Compartments 1/4" Dividers | | | |

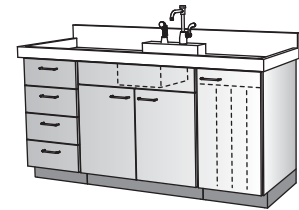

Wall Cleanup Center

W	H	D
78	42	30

16 Gauge Stainless Steel Top (36" High at Trough Rim)
10" Deep Trough Sink
High Back Faucet Riser
(3) 52269-6A Cold Water Faucets with Aerators
(1) 52J35 Strainer

35344

INCLUDES:

- | | W | H | D |
|----------------------------------|-------------------------|----|----|
| (1) 10121 | 24 | 26 | 23 |
| Left Hinge Door Adjustable Shelf | | | |
| (1) 10473 | 24 | 26 | 23 |
| Right Hinge Door | | | |
| (1) 91036 | Sink Apron Tub Assembly | | |

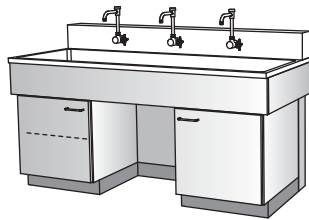

ADA Rinse Away Center

W	H	D
74	39	25
81		

16 Gauge Stainless Steel Rinse Sink with 2" Rim
34" Max. ADA Height Rim
Integral 10" x 12" x 4" Center Drain Sink
(1) 52262-6AWB Cold Water Faucet with Wrist Blade Handle
(1) Deck Mount Pre-Rinse Spray Unit
(1) 52J35 Strainer

35346

INCLUDES:

- | | W | H | D |
|------------------------------------|----|----|----|
| (1) 35360 | 18 | 31 | 24 |
| 4 Equal Drawers | | | |
| (1) 35363 | 36 | 22 | 24 |
| Access Panel | | | |
| (1) 35361 | 18 | 31 | 24 |
| 21
4 Compartments 1/4" Dividers | | | |

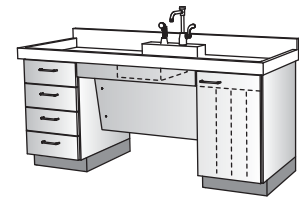

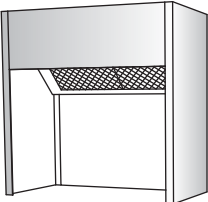
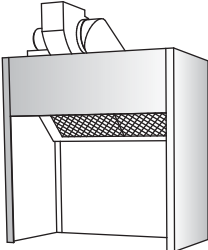
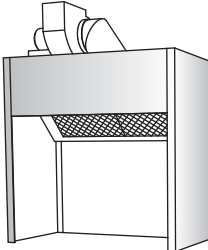
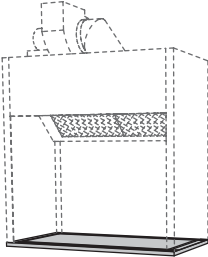
Spray Booth			Spray Booth Top		
W H D 48 48 24	W H D 48 48 24	W H D 48 48 24	W H D 48 00 24		
Steel Spray Booth Vapor Proof Light Changeable Filters	Steel Spray Booth Vapor Proof Light Blower with TEFC Motor Changeable Filters	Steel Spray Booth Explosion Proof Light Blower with Explosion Proof Motor Changeable Filters	¾" Black Phenolic Top with Perimeter Spill Grooves		
52016	52017	52018	35924		
					

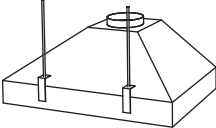
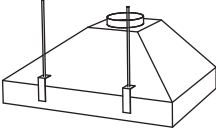
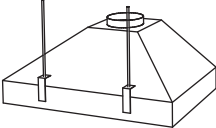
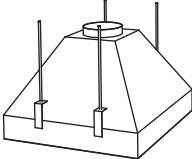
Wall Canopy Hood			Island Canopy Hood		
W H D 24 24 30 30 36 48 60 72	W H D 24 24 30 30 36 48 60 72	W H D 24 24 30 30 36 48 60 72	W H D 24 24 30 30 36 48 60 72		
Sloped Sides 18 Gauge Steel Powder Coated Finish 2 Threaded Mounting Rods	Sloped Sides 18 Gauge Steel Powder Coated Finish 2 Threaded Mounting Rods	Sloped Sides 18 Gauge Steel Powder Coated Finish 2 Threaded Mounting Rods	Island Style 18 Gauge Steel Powder Coated Finish 4 Threaded Mounting Rods		
52024	52024	52024	52026		
					

ARTS AND CRAFTS

Paper Storage

Paper storage drawers are equipped with ball bearing full extension type slides.
All depths may not extend full drawer depth.



W	H	D
48	29	24
	35	29
		34

5 Equal Drawers
Full Extension

10403

W	H	D
48	35	24
		29
		34

6 Equal Drawers
Full Extension

10404

W	H	D
48	35	24
		29
		34

7 Equal Drawers
Full Extension

10405

W	H	D
48	35	24
		29
		34

8 Equal Drawers
Full Extension

10406

W	H	D
48	35	24
		29
		34

Doors
6 Rollout Shelves
Full Extension

10407

29H



35H

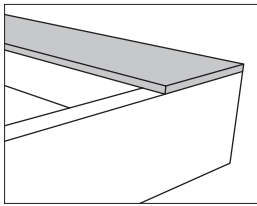
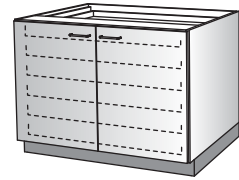

Paper storage drawers include rear retaining hoods.

Paper Storage Drawer Units

Unit Size		Paper Size	
W	D	W	D
48	24	46	20
48	29	46	24
48	34	46	28



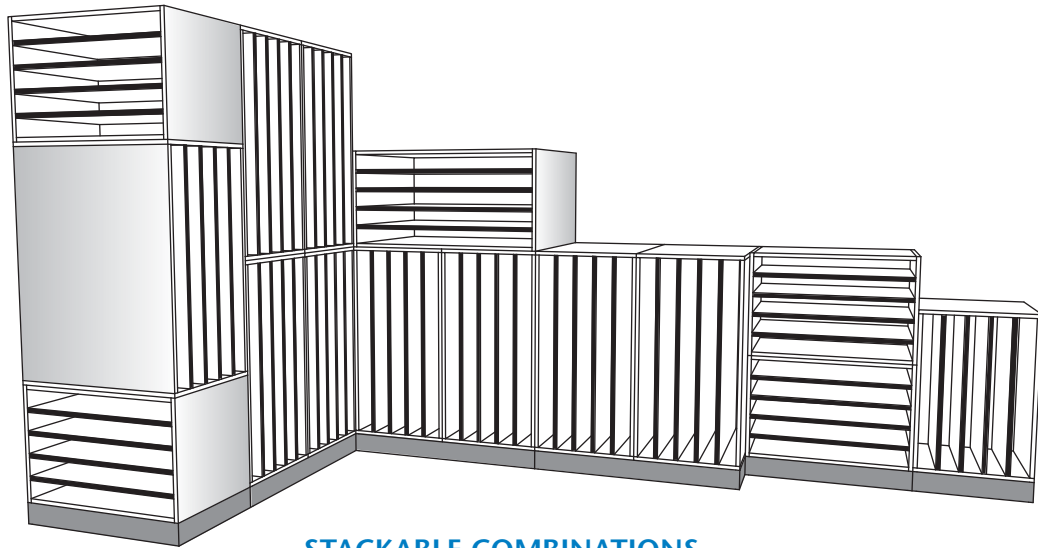

Paper Storage Rollout Shelf Units

Unit Size		Paper Size	
W	D	W	D
48	24	42	19
48	29	42	24
48	34	42	30

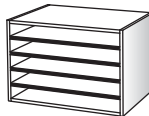
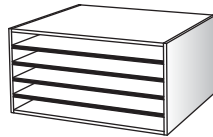
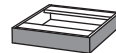
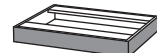
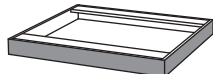
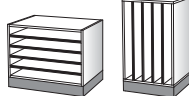

STACKABLE COMBINATIONS

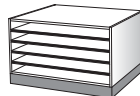
Available in White TFL Finish

Stackable			Stackable Base											
W	H	D	W	H	D	W	H	D	W	H	D			
33	22	22	43	22	33	22	04	22	33	04	22	43	04	33
<p>Holds 30 x 20 Materials Can be used in horizontal orientation with 22711 Stackable Base Can be used in vertical orientation with 22710 Stackable Base</p>			<p>Holds 40 x 30 Materials Can be used in horizontal orientation with 22712 Stackable Base Can be used in vertical orientation with 22711 Stackable Base</p>											
22700			22701			22710			22711			22712		
														
 			 											
Stackables shown with Bases														

ARTS AND CRAFTS

Project Storage

Actual 24D compartment depth = 21 $\frac{7}{8}$ "
 Actual 29D compartment depth = 26 $\frac{7}{8}$ "



W H D
 18 35 24
 29

4 Compartments:
 Min. Opening 3"
 3/4" Dividers

10513

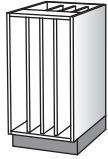

W H D
 24 35 24
 29

6 Compartments:
 Min. Opening 3"
 3/4" Dividers

10514



W H D
 33 35 24
 29

8 Compartments:
 Min. Opening 3"
 3/4" Dividers

10515

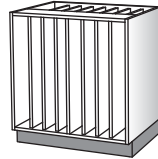

W H D
 39 35 24
 29

10 Compartments:
 Min. Opening 3"
 3/4" Dividers

10516

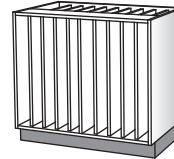

W H D
 48 35 24
 29

12 Compartments:
 Min. Opening 3"
 3/4" Dividers

10517

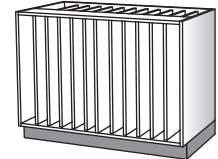

10519

Right
 Hinge
 Door

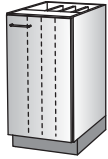

10521



10523

Double
 Doors

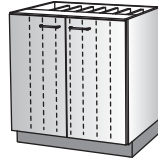

10524

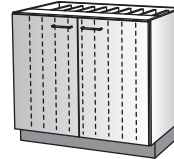

10525

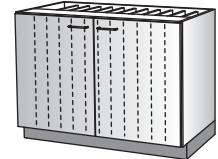

10520

Left
 Hinge
 Door





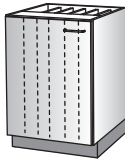







10522

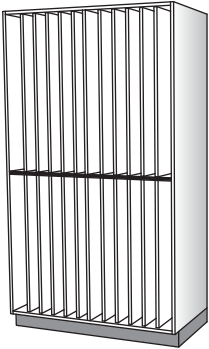

Project Storage

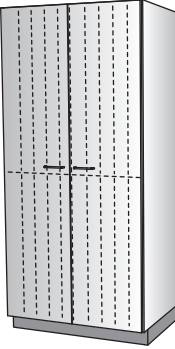
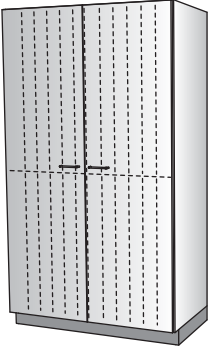
Actual 24D compartment depth = 21 $\frac{7}{8}$ "
Actual 29D compartment depth = 26 $\frac{7}{8}$ "

W H D	W H D	W H D	W H D	W H D
18 84 24 29	24 84 24 29	33 84 24 29	39 84 24 29	48 84 24 29
8 Compartments: Min. Opening 3" $\frac{3}{4}$ " Dividers	12 Compartments: Min. Opening 3" $\frac{3}{4}$ " Dividers	16 Compartments: Min. Opening 3" $\frac{3}{4}$ " Dividers	20 Compartments: Min. Opening 3" $\frac{3}{4}$ " Dividers	24 Compartments: Min. Opening 3" $\frac{3}{4}$ " Dividers
25513	25514	25515	25516	25517
				
25519	25521	25523	25524	25525
				
				Right Hinge Door
				Double Doors
25520	25522			
				
				Left Hinge Door

ARTS AND CRAFTS

Project Storage

Actual 24D compartment depth = 21⁷/₈"
 Actual 29D compartment depth = 26⁷/₈"



W H D
 33 84 24
 29

8 Vertical Compartments
 10 Horizontal Compartments
 Minimum Opening 3"
 3/4" Dividers and Adjustable Shelves

25545



W H D
 33 84 24
 29

Doors
 8 Vertical Compartments
 10 Horizontal Compartments
 Minimum Opening 3"
 3/4" Dividers and Adjustable Shelves

25546



W H D
 39 84 24
 29

10 Vertical Compartments
 10 Horizontal Compartments
 Minimum Opening 3"
 3/4" Dividers and Adjustable Shelves

25547

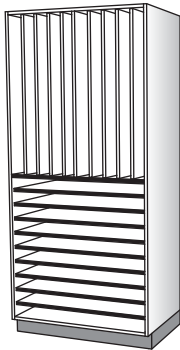

W H D
 39 84 24
 29

Doors
 10 Vertical Compartments
 10 Horizontal Compartments
 Minimum Opening 3"
 3/4" Dividers and Adjustable Shelves

25548



Drafting Board Storage - Horizontal

W H D
26 84 24

Upper and Lower Doors
Holds (26) 18 x 24 Boards on Rails

25752



W H D
28 84 24

Upper and Lower Doors
Holds (26) 20 x 26 Boards on Rails

25753



Drafting Board Storage - Vertical

W H D
36 84 24

Doors
Holds (26) 18 x 24 or
(26) 20 x 26 Boards on Rails

25754



W H D
36 84 24

Upper and Lower Doors
Holds (26) 18 x 24 or
(26) 20 x 26 Boards on Rails

25755



ARTS AND CRAFTS

Crafts/Specialty Storage



Crafts Storage

W H D
48 84 24

Doors
Upper Compartment: Pegboard Lined
Lower Compartment: Center Divider
Adjustable Shelves

25690

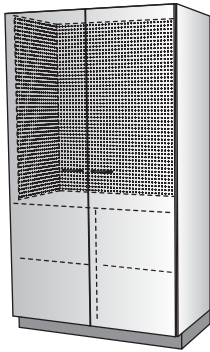

W H D
36 84 24

Upper Compartment: Doors
Pegboard Lined
Lower Compartment: Doors
(18) SA902 Trays

25694

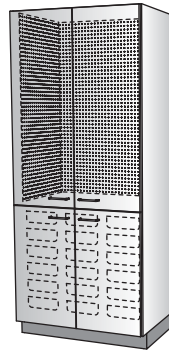

W H D
48 84 24

Upper Compartment: Doors
Pegboard Lined
Lower Compartment: Doors
(18) SA901 Trays

25695

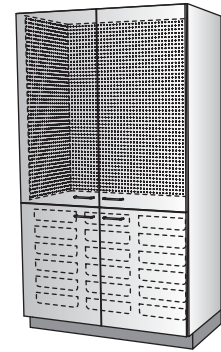

Molded trays with card holder:
SA901: 14 1/4" W x 3 1/2" H x 19" D
SA902: 10" W x 3 1/2" H x 19" D

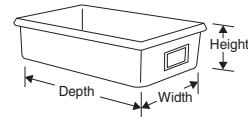

Wheeled Cart Storage

Interior Widths	W	H	D	Interior Depths
34"	36	84	24	21 7/8"
37"	39		29	26 7/8"
40"	42			
43"	45			
46"	48			

Doors
Fixed Shelf

25704

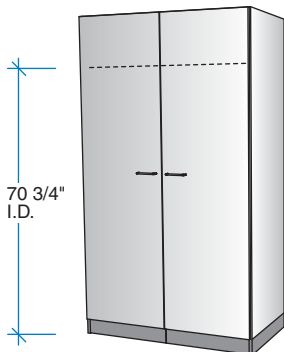

Germicidal Cabinet

W H D
25 32 10



For Sanitizing and Storage of 48 Safety Glasses or
40 Goggles (available separately, see page 25)
24-gauge White Enameled Lockable Steel Cabinet
Doors Interlocked with Tamper-Resistant Latches
Wall- or Shelf-Mountable with 7' Grounded
Electrical Cord
5-minute Cycle Controlled by Timer

52192

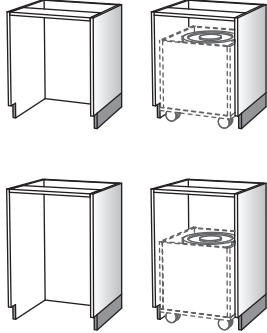

(Glasses/Goggles not included)

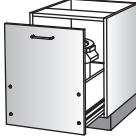
Mobile Clay Cart	Clay Cart Port
<p>W H D 20 22 20</p> <p>20-Gallon Tub with Lid Plywood Core Construction</p>	<p>W H D 24 29 21 35</p> <p>Designed to store 10685 Mobile Clay Cart</p>
10685	10683
	 <p>29H</p> <p>35H</p> <p>10685 Mobile Clay Cart not included</p>

Pullout Dry Bulk Storage	
<p>W H D 21 29 24 24</p> <p>20-Gallon Tub with Lid 200# Full Extension Ball Bearing Drawer Track Plywood Core Pullout Drawer</p>	<p>W H D 21 35 24 24</p> <p>Drawer 20-Gallon Tub with Lid 200# Full Extension Ball Bearing Drawer Track Plywood Core Pullout Drawer</p>
10686	10687
	 <p>29H</p> <p>35H</p>

ARTS AND CRAFTS

Material Storage



Vented Damp Storage

W H D
36 35 24
39
42
48

Framed Expanded Metal Doors
2 Wire Shelves
Drip Pan

10680

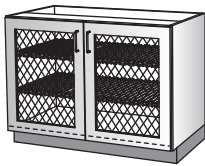

W H D
36 84 24
39
42
48

Framed Expanded Metal Doors
5 Wire Shelves
Drip Pan

25680



Damp Storage with Seal

W H D
36 35 24
39
42
48

Doors
2 Wire Shelves
Drip Pan

10681

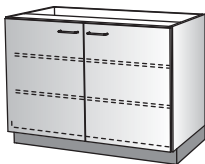

W H D
36 84 24
39
42
48

Doors
5 Wire Shelves
Drip Pan

25681



Damp Storage with Seal – Galvanized

W H D
36 84 24
39
42
48

Galvanized Liner
Doors
5 Wire Shelves
Drip Pan

25693

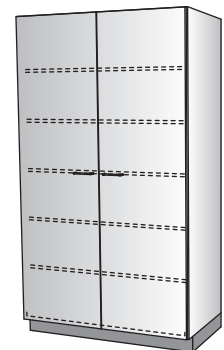

Advantage Goggle

UV-absorbing Polycarbonate Lens
Tinted Flexible Body
Adjustable Headband
Indirect Vent
Fits Over Most Prescription Eyewear
Replaceable Lens
Meets ANSI Z87.1-2003 Standards
CUL Certified to Meet CAN/CSA-Z94.3 Standards
(direct vent model shown below)

52194



Plaster and Sediment Trap

W H D
09 12 09

Compatible with All Craft Sinks
White Translucent Poly 1½-Gal. Capacity
(2) 1½" Inlets
(1) 2" Outlet
(1) 3" Cleanout

52P97

Dimensions (in)

A	B	C
9	12	6 7/8

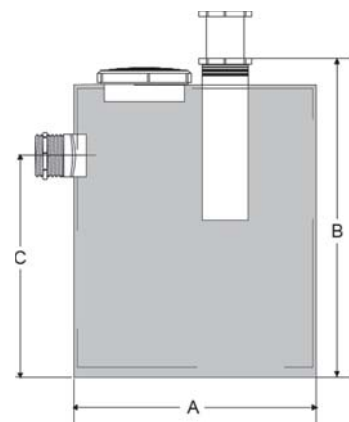

ARTS AND CRAFTS

Vises



Woodworking Vise

7" Jaws – 8" Opening
Sliding Stop-Dog
Quick Release for Speedy Adjustment
Heavy Cast Iron Construction
Acme Screw and Polished Guides
Mounts on Tops 1½" to 2¼" Thick

35620

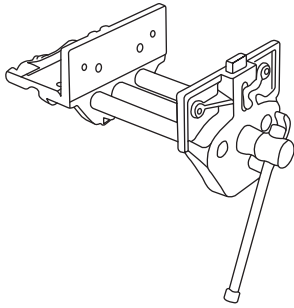

9" Jaws – 10¼" Opening
Sliding Stop-Dog
Quick Release for Speedy Adjustment
Heavy Cast Iron Construction
Acme Screw and Polished Guides
Mounts on Tops 1½" to 2¼" Thick

35621

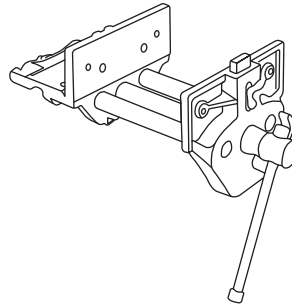

8" Jaws – 7¼" Opening
Guide Bars and Thread Screw
Cast Iron Construction
Mounts on Tops 1½" to 2¼" Thick

35622

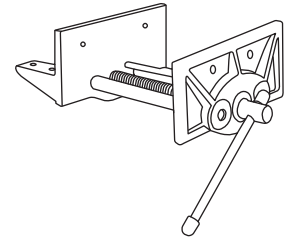

Bench Vise

4" Bench Vise with Anvil
4" Jaws
Machined Center Slide
Large Acme Screw
Anvil Face
Swivel Base Rotates 0° to 90°

35623

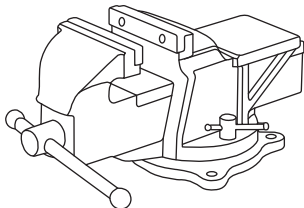

4" Multi-Purpose Vise
4" Jaw Opening
Jaws Rotate 360°
Jaws Hold Flat Stock and Rounds
Anvil Face
Swivel Base Rotates 0° to 90°

35624

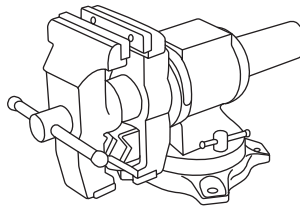

Multi-Purpose Vise

5" Multi-Purpose Vise
5" Jaw Opening
Jaws Rotate 360°
Jaws Hold Flat Stock and Rounds
Anvil Face
Swivel Base Rotates 0° to 90°

35625

