

Table of Contents



Shelf 3-4



Display..... 5



Blind Corner..... 6



Diagonal Corner 7



L-Shaped Corner..... 7



Cubicle..... 8

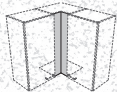

Installation Accessories..... 9















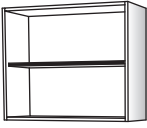

Reagent Shelving..... 10-12

WALL

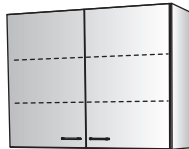
Laboratory Cabinetry and Specialties



W	H	D	W	H	D	W	H	D	W	H	D	W	H	D	W	H	D	W	H	D
12	16	14	12	16	14	12	25	14	12	16	14	12	25	14	24	16	14	24	25	14
15	18	17	15	18	17	15	30	17	15	18	17	15	30	17	27	18	17	27	30	17
18	25		18			18	36		18			18	36		30			30	36	
21	30					21	42					21	42		33			33	42	
24	36					24						24			36			36		
27	42																	39		
30																		42		
33																		45		
36																		48		
Adjustable Shelves (25H – 42H only)	Right Hinge Door	Right Hinge Door Adjustable Shelves	Left Hinge Door	Left Hinge Door Adjustable Shelves	Doors	Doors Adjustable Shelves														
15101	15120	15120	15121	15121	15129	15129														
																				
																				
																				
																				

16H
18H

25H
30H

36H

42H

WALL

Shelf

W	H	D
39	16	14
42	18	17
45	25	
48	30	
	36	
	42	

Center Divider
Adjustable Shelves
(25H - 42H only)

W	H	D
39	16	14
42	18	17
45	25	
48	30	
	36	
	42	

Doors
Center Divider
Adjustable Shelves
(25H - 42H only)

W	H	D
36	16	14
39	18	17
42	25	
45	30	
48	36	
	42	

Sliding Doors
Center Divider
Adjustable Shelves
(25H - 42H only)

15138

15181

15150

16H
18H

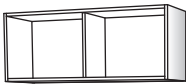

25H
30H

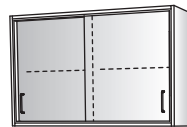
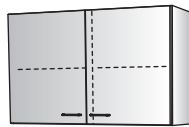
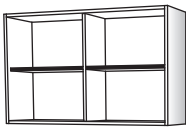

36H

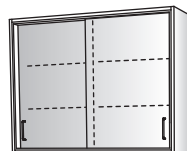
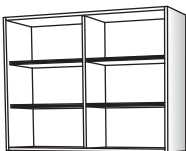

42H

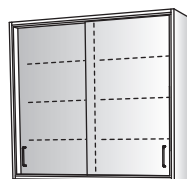
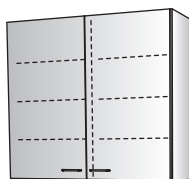

WALL

Blind Corner



W	H	D
33	16	14
36	18	
	25	
	30	
	36	
	42	

36	16	17
39	18	
	25	
	30	
	36	
	42	

Right Hinge Door
Adjustable Shelves
(25H - 42H only)

W	H	D
33	16	14
36	18	
	25	
	30	
	36	
	42	

36	16	17
39	18	
	25	
	30	
	36	
	42	

Left Hinge Door
Adjustable Shelves
(25H - 42H only)

W	H	D
33	25	14
36	30	
	36	
	42	

36	25	17
39	30	
	36	
	42	

Right Hinge Display Door
Adjustable Shelves

W	H	D
33	25	14
36	30	
	36	
	42	

36	25	17
39	30	
	36	
	42	

Left Hinge Display Door
Adjustable Shelves

15200

15201

15202

15203

16H
18H

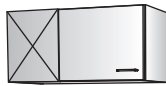
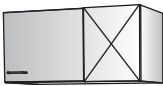

25H
30H

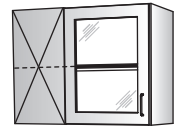
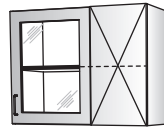
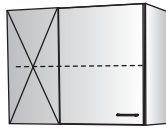
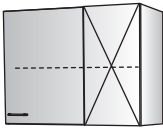



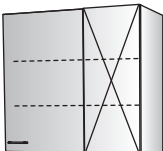



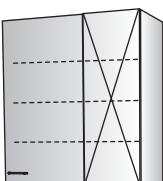



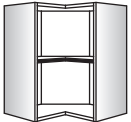

36H

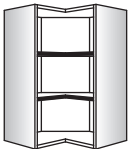

42H

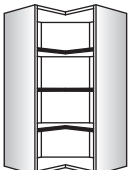

Diagonal Corner/L-Shaped Corner

Diagonal Corner			Diagonal Corner			L-Shaped Corner			L-Shaped Corner					
W	H	D	W	H	D	W	H	D	W	H	D	W	H	D
25	25	14	25	25	14	26	25	14	26	25	14	26	25	14
	30			30			30			30			30	
	36			36			36			36			36	
	42			42			42			42			42	
<hr/>			<hr/>			<hr/>			<hr/>			<hr/>		
28	25	17	28	25	17	29	25	17	29	25	17	29	25	17
	30			30			30			30			30	
	36			36			36			36			36	
	42			42			42			42			42	
Right Hinge Door Fixed Shelves			Left Hinge Door Fixed Shelves			Fixed Shelves			Right Hinge Folding Door Fixed Shelves			Left Hinge Folding Door Fixed Shelves		
15211			15212			15219			15215			15216		
														
			25H 30H									25H 30H		
														
			36H									36H		
														
			42H									42H		

WALL

Cubicle

3/4" adjustable and removable cubicle shelves.



Compt. Widths	W	H	D
7 7/8"	18	25	14
9 3/8"	21	30	17
10 7/8"	24	36	42

Right Hinge Door
Cubicle Shelves

W	H	D
18	25	14
21	30	17
24	36	42

Left Hinge Door
Cubicle Shelves

Compt. Widths	W	H	D
9"	30	25	14
11"	36	30	17
13"	42	36	42
15"	48	42	42

Doors
Cubicle Shelves

Compt. Widths	W	H	D
8"	36	25	14
9 1/2"	42	30	17
11"	48	36	42

Doors
Cubicle Shelves

15222

15223

15227

15240

25H
6 Compts.
6 3/4"H



25H
9 Compts.
6 3/4"H

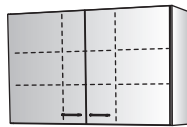

25H
12 Compts.
6 3/4"H



30H
6 Compts.
8"H



30H
9 Compts.
8"H

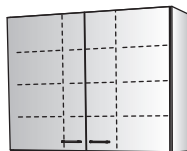

30H
12 Compts.
8"H



36H
8 Compts.
8"H



36H
12 Compts.
8"H

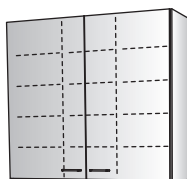



36H
16 Compts.
8"H



42H
10 Compts.
6 3/4"H

42H
15 Compts.
6 3/4"H

42H
20 Compts.
6 3/4"H

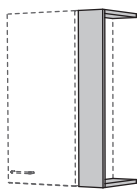
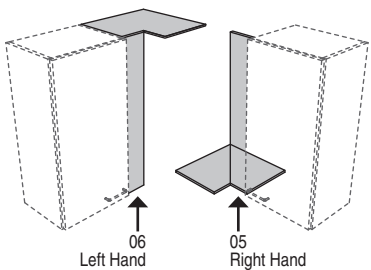
Soffit Trim	Vertical Scribe	Front Filler	Corner Filler/Closures																																																																															
<p>3/4"-thick soffit trim and vertical scribe front edgbanding matches adjacent cabinet edge.</p> <table border="1"> <thead> <tr> <th>W</th> <th>H</th> <th>D</th> </tr> </thead> <tbody> <tr> <td>96</td> <td>00</td> <td>02</td> </tr> <tr> <td></td> <td></td> <td>03</td> </tr> </tbody> </table> <p>Field Trim to Fit</p>	W	H	D	96	00	02			03	<table border="1"> <thead> <tr> <th>W</th> <th>H</th> <th>D</th> </tr> </thead> <tbody> <tr> <td>00</td> <td>16</td> <td>02</td> </tr> <tr> <td></td> <td>18</td> <td>03</td> </tr> <tr> <td></td> <td>25</td> <td></td> </tr> <tr> <td></td> <td>30</td> <td></td> </tr> <tr> <td></td> <td>36</td> <td></td> </tr> <tr> <td></td> <td>42</td> <td></td> </tr> </tbody> </table> <p>Field Trim to Fit</p>	W	H	D	00	16	02		18	03		25			30			36			42		<table border="1"> <thead> <tr> <th>W</th> <th>H</th> <th>D</th> </tr> </thead> <tbody> <tr> <td>02</td> <td>16</td> <td>14</td> </tr> <tr> <td>03</td> <td>18</td> <td>17</td> </tr> <tr> <td>06</td> <td>25</td> <td></td> </tr> <tr> <td>09</td> <td>30</td> <td></td> </tr> <tr> <td>12</td> <td>36</td> <td></td> </tr> <tr> <td></td> <td>42</td> <td></td> </tr> </tbody> </table> <p>Includes Top and Bottom Closure Panels Field Trim to Fit</p>	W	H	D	02	16	14	03	18	17	06	25		09	30		12	36			42		<table border="1"> <thead> <tr> <th>W</th> <th>H</th> <th>D</th> <th>**</th> </tr> </thead> <tbody> <tr> <td>02</td> <td>16</td> <td>14</td> <td></td> </tr> <tr> <td>03</td> <td>18</td> <td>17</td> <td></td> </tr> <tr> <td>06</td> <td>25</td> <td></td> <td></td> </tr> <tr> <td>09</td> <td>30</td> <td></td> <td></td> </tr> <tr> <td>12</td> <td>36</td> <td></td> <td></td> </tr> <tr> <td></td> <td>42</td> <td></td> <td></td> </tr> </tbody> </table> <p>Field Trim to Fit</p>	W	H	D	**	02	16	14		03	18	17		06	25			09	30			12	36				42		
W	H	D																																																																																
96	00	02																																																																																
		03																																																																																
W	H	D																																																																																
00	16	02																																																																																
	18	03																																																																																
	25																																																																																	
	30																																																																																	
	36																																																																																	
	42																																																																																	
W	H	D																																																																																
02	16	14																																																																																
03	18	17																																																																																
06	25																																																																																	
09	30																																																																																	
12	36																																																																																	
	42																																																																																	
W	H	D	**																																																																															
02	16	14																																																																																
03	18	17																																																																																
06	25																																																																																	
09	30																																																																																	
12	36																																																																																	
	42																																																																																	
15801	15802	15803	15805																																																																															
			 <p>06 Left Hand 05 Right Hand</p>																																																																															
			<p>** Use 2-digit code to select right hand or left hand filler</p> <table border="1"> <thead> <tr> <th>Code</th> <th>15805 Corner Filler/Closures</th> </tr> </thead> <tbody> <tr> <td>05</td> <td>Right Hand</td> </tr> <tr> <td>06</td> <td>Left Hand</td> </tr> </tbody> </table>	Code	15805 Corner Filler/Closures	05	Right Hand	06	Left Hand																																																																									
Code	15805 Corner Filler/Closures																																																																																	
05	Right Hand																																																																																	
06	Left Hand																																																																																	

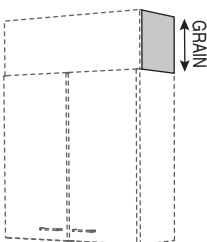
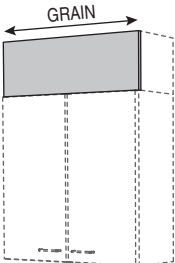
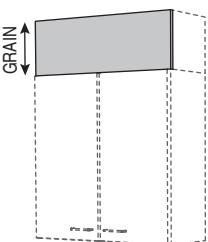
End Soffit Closure	Horizontal Grain Soffit Fascia	Vertical Grain Soffit Fascia																																																									
<table border="1"> <thead> <tr> <th>W</th> <th>H</th> <th>D</th> </tr> </thead> <tbody> <tr> <td>00</td> <td>12</td> <td>14</td> </tr> <tr> <td></td> <td>18</td> <td>17</td> </tr> <tr> <td></td> <td>24</td> <td></td> </tr> </tbody> </table> <p>Field Trim to Fit</p>	W	H	D	00	12	14		18	17		24		<table border="1"> <thead> <tr> <th>W</th> <th>H</th> <th>D</th> </tr> </thead> <tbody> <tr> <td>36</td> <td>12</td> <td>00</td> </tr> <tr> <td>48</td> <td>18</td> <td></td> </tr> <tr> <td>60</td> <td>24</td> <td></td> </tr> <tr> <td>72</td> <td></td> <td></td> </tr> <tr> <td>84</td> <td></td> <td></td> </tr> <tr> <td>96</td> <td></td> <td></td> </tr> </tbody> </table> <p>Field Trim to Fit</p>	W	H	D	36	12	00	48	18		60	24		72			84			96			<table border="1"> <thead> <tr> <th>W</th> <th>H</th> <th>D</th> </tr> </thead> <tbody> <tr> <td>12</td> <td>33</td> <td>12</td> </tr> <tr> <td>15</td> <td>36</td> <td>18</td> </tr> <tr> <td>18</td> <td>39</td> <td>24</td> </tr> <tr> <td>21</td> <td>42</td> <td></td> </tr> <tr> <td>24</td> <td>45</td> <td></td> </tr> <tr> <td>27</td> <td>48</td> <td></td> </tr> <tr> <td>30</td> <td></td> <td></td> </tr> </tbody> </table> <p>Field Trim to Fit</p>	W	H	D	12	33	12	15	36	18	18	39	24	21	42		24	45		27	48		30		
W	H	D																																																									
00	12	14																																																									
	18	17																																																									
	24																																																										
W	H	D																																																									
36	12	00																																																									
48	18																																																										
60	24																																																										
72																																																											
84																																																											
96																																																											
W	H	D																																																									
12	33	12																																																									
15	36	18																																																									
18	39	24																																																									
21	42																																																										
24	45																																																										
27	48																																																										
30																																																											
15820	15822	15823																																																									
																																																											
Shown with 15822/15823 Soffit Fascia	Shown with 15820 End Soffit Closure	Shown with 15820 End Soffit Closure																																																									

Heavy Duty Standards & Brackets **45350**
Stainless Steel Standards & Brackets **45352**

With Seismic Retaining Rails Included:
Heavy Duty Standards & Brackets **45351**
Stainless Steel Standards & Brackets **45353**

W	H	D	**
24	24	10	
36		12	
48			

24H
(2) Shelves

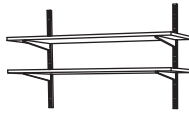

Heavy Duty Standards & Brackets **45366**
Stainless Steel Standards & Brackets **45368**

With Seismic Retaining Rails Included:
Heavy Duty Standards & Brackets **45367**
Stainless Steel Standards & Brackets **45369**

W	H	D	**
60	24	10	
72		12	
84			
96			



FEATURES

- Heavy duty 12-gauge brackets and standards with 2" adjustment
- Shelving available in three materials (see chart below)
- Height indicates vertical length of standard
- Shelving width is 1/2" narrower and depth is 1/4" shallower than dimensions shown

SHELVING MATERIALS

** Use 2-digit code to select shelving material

Code	Shelving Material
24	3/4" Phenolic with buffed edges - Black
29	1" Epoxy - Black
34	1" A-tech with 3mm edge - Black

(e.g., **4535036241224** for 45350 Reagent Shelving, 36W x 24H x 12D, with 3/4" Black Phenolic shelves with buffed edges)

Heavy Duty Standards & Brackets **45354**
Stainless Steel Standards & Brackets **45356**

With Seismic Retaining Rails Included:
Heavy Duty Standards & Brackets **45355**
Stainless Steel Standards & Brackets **45357**

W	H	D	**
24	36	10	
36		12	
48			

36H
(3) Shelves





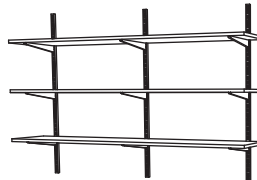

Heavy Duty Standards & Brackets **45370**
Stainless Steel Standards & Brackets **45372**

With Seismic Retaining Rails Included:
Heavy Duty Standards & Brackets **45371**
Stainless Steel Standards & Brackets **45373**

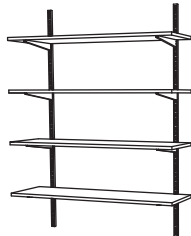
W	H	D	**
60	36	10	
72		12	
84			
96			

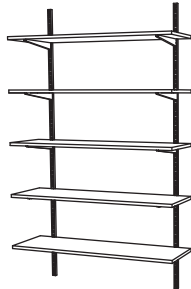

Heavy Duty Standards & Brackets 45358	Heavy Duty Standards & Brackets 45374																																				
Stainless Steel Standards & Brackets 45360	Stainless Steel Standards & Brackets 45376																																				
With Seismic Retaining Rails Included:	With Seismic Retaining Rails Included:																																				
Heavy Duty Standards & Brackets 45359	Heavy Duty Standards & Brackets 45375																																				
Stainless Steel Standards & Brackets 45361	Stainless Steel Standards & Brackets 45377																																				
<table border="1"> <thead> <tr> <th>W</th> <th>H</th> <th>D</th> <th>**</th> </tr> </thead> <tbody> <tr> <td>24</td> <td>48</td> <td>10</td> <td></td> </tr> <tr> <td>36</td> <td>60</td> <td>12</td> <td></td> </tr> <tr> <td>48</td> <td></td> <td></td> <td></td> </tr> </tbody> </table>	W	H	D	**	24	48	10		36	60	12		48				<table border="1"> <thead> <tr> <th>W</th> <th>H</th> <th>D</th> <th>**</th> </tr> </thead> <tbody> <tr> <td>60</td> <td>48</td> <td>10</td> <td></td> </tr> <tr> <td>72</td> <td>60</td> <td>12</td> <td></td> </tr> <tr> <td>84</td> <td></td> <td></td> <td></td> </tr> <tr> <td>96</td> <td></td> <td></td> <td></td> </tr> </tbody> </table>	W	H	D	**	60	48	10		72	60	12		84				96			
W	H	D	**																																		
24	48	10																																			
36	60	12																																			
48																																					
W	H	D	**																																		
60	48	10																																			
72	60	12																																			
84																																					
96																																					
																																					
	48H 60H (4) Shelves																																				

Heavy Duty Standards & Brackets 45362	Heavy Duty Standards & Brackets 45378																																				
Stainless Steel Standards & Brackets 45364	Stainless Steel Standards & Brackets 45380																																				
With Seismic Retaining Rails Included:	With Seismic Retaining Rails Included:																																				
Heavy Duty Standards & Brackets 45363	Heavy Duty Standards & Brackets 45379																																				
Stainless Steel Standards & Brackets 45365	Stainless Steel Standards & Brackets 45381																																				
<table border="1"> <thead> <tr> <th>W</th> <th>H</th> <th>D</th> <th>**</th> </tr> </thead> <tbody> <tr> <td>24</td> <td>72</td> <td>10</td> <td></td> </tr> <tr> <td>36</td> <td>84</td> <td>12</td> <td></td> </tr> <tr> <td>48</td> <td></td> <td></td> <td></td> </tr> </tbody> </table>	W	H	D	**	24	72	10		36	84	12		48				<table border="1"> <thead> <tr> <th>W</th> <th>H</th> <th>D</th> <th>**</th> </tr> </thead> <tbody> <tr> <td>60</td> <td>72</td> <td>10</td> <td></td> </tr> <tr> <td>72</td> <td>84</td> <td>12</td> <td></td> </tr> <tr> <td>84</td> <td></td> <td></td> <td></td> </tr> <tr> <td>96</td> <td></td> <td></td> <td></td> </tr> </tbody> </table>	W	H	D	**	60	72	10		72	84	12		84				96			
W	H	D	**																																		
24	72	10																																			
36	84	12																																			
48																																					
W	H	D	**																																		
60	72	10																																			
72	84	12																																			
84																																					
96																																					
																																					
	72H 84H (5) Shelves																																				



Seismic Retaining Rails

W H D
 08 1¼ 5/16
 21¼
 33¼
 8W Rails Designed
 for Shelf Ends

15850



Seismic Retaining Rails Set

W H D
 24 1¼ 5/16
 36
 48
 72
 96

Specify by Shelf Width

15852

Shelf Width	Retaining Rail Set Includes:
24"	21¼"
36"	33¼"
48"	21¼" 21¼"
72"	33¼" 33¼"
96"	33¼" 21¼" 33¼"