



# UPDATE HISTORY

## Countertops Section



This UPDATE HISTORY outlines changes made to the Countertops section of the Stevens Advantage Commercial Cabinetry and Millwork catalog since May 2017.

The most recent updates are shown first.

Go to [stevensadvantage.com](http://stevensadvantage.com)

→ RESOURCES

→ Commercial Casework

to view/download/print  
the most current catalog sections.

Later updates supercede earlier updates.

(Revisions shown in **RED**)

# UPDATE HISTORY

## Countertops Section



MAY 2018			
MODEL #	TYPE OF UPDATE	DESCRIPTION OF UPDATE	CATALOG PAGE #
LS00, LS10, LS15, LS16	Construction	Radius of 90° seamless postform edges changed from 10mm to 13mm	6-9
LS15, LS16	Construction	Discontinued 21mm countertop thickness	8-9
LS60, LS64, LS65, LS67, LS68, LS70, LS71	Construction	Radius of 90° seamless postform edges changed from 10mm to 13mm	11-14
LS51, LS52	Construction	Radius of 90° seamless postform edges changed from 10mm to 13mm	43-44
LS52	Construction	Discontinued 21mm top thickness	44
All PS Series	Construction	Solid surface thickness changed from 13mm to 12mm	15-26, 45-46
PS59-PS68, PS72, PS79-PS88, PS92	Description	Added verbiage to explain drop edge availability	15-26

MARCH 2018			
MODEL #	TYPE OF UPDATE	DESCRIPTION OF UPDATE	CATALOG PAGE #
	Description	"TFL" added to Glossary of Terms	5
	Description	MDF cores added to "Countertop Core/Substrate Codes"	5
BW00	Product Offering	Discontinued series	30
All GS Series	Description	Added thickness dimensions in centimeters	36-37
All LS Series	Construction	MDF cores added; 30mm thicknesses changed from "special order" to standard for particleboard and MDF cores	6-14, 42-44
All MS Series	Description	Added thickness dimensions in centimeters	38-39
All QS Series	Description	Added thickness dimensions in centimeters	40-41
LS50	Description	Noted on illustrations that drop edge thickness is same thickness as top; noted that 30mm thick windowsills also require custom drop edge height	42
LS51 & LS52	Description	Noted on illustrations that drop edge thickness must be greater than 1"; noted that drop edge is not available for 30mm and 40mm thick windowsills	43-44
PS59-PS68, PS72	Construction	On illustrations: For particleboard cores, "Backer" changed to "White TFL"; banding added to all edges of Core Substrate	15-20
PS59-PS68, PS72	Description	"S" core code for backsplashes/endsplashes defined as "Solid"	15-20
PS59-PS68, PS72	Construction	MDF cores added	15-20
PS79-PS88, PS92	Construction	On illustrations: For particleboard cores, "Backer" changed to "White TFL"; banding added to all edges of Core Substrate	21-26
PS79-PS88, PS92	Description	"S" core code for endsplashes defined as "Solid"	21-26
PS79-PS88, PS92	Construction	MDF cores added	21-26
AP00-AP05	Construction	1" thickness added	33-35



# UPDATE HISTORY

## Countertops Section

DECEMBER 2017			
MODEL #	TYPE OF UPDATE	DESCRIPTION OF UPDATE	CATALOG PAGE #
PS59-PS68, PS72	Description	Changed Backsplash model number to PB72S13; changed Endsplash model number to PE72S13	15-20
PS79-PS88, PS92	Description	Changed Endsplash model number to PE72S13	21-26

OCTOBER 2017			
MODEL #	TYPE OF UPDATE	DESCRIPTION OF UPDATE	CATALOG PAGE #
ES02	Construction/Description	Deleted drip groove	28
ES03	Construction/Description	Deleted drip groove	28

# UPDATE HISTORY

Countertops Section



## Table of Contents

Terms and Codes ..... 5

### COUNTERTOPS

**Laminate Series** ..... 6-10

LS00: 90° postform edge top, applied 90° postform edge  
backsplash, applied self edge endsplash ..... 6

LS05: 3mm edge top, applied 3mm edge backsplash and  
endsplash ..... 6

LS07: Self edge top, applied self edge backsplash and  
endsplash ..... 7

LS10: 90° postform edge top, integral covered 90° postform edge  
backsplash, applied self edge endsplash ..... 7

LS11: 3mm edge top, integral covered 3mm edge backsplash,  
applied 3mm edge endsplash ..... 8

LS15: 180° postform edge top, applied 90° postform edge  
backsplash, applied self edge endsplash ..... 8

LS16: 180° postform edge top, integral covered 90° postform  
edge backsplash, applied self edge endsplash ..... 9

LS25: Chemsurf face laminate, 3mm edge top, applied 3mm  
edge backsplash and endsplash ..... 10

LS26: Chemsurf face laminate, self edge top, applied self edge  
backsplash and endsplash ..... 10

**Wood Edge Laminate Series:** Profile wood edge top,  
applied 90° postform edge  
backsplash, applied self edge  
endsplash ..... 11-14

LS60: 3R/3R profile top ..... 11

LS64: 6R/6R profile top ..... 11

LS65: 12B/0 profile top ..... 12

LS67: 12R/0 profile top ..... 12

LS68: 12R/12R profile top ..... 13

LS70: Bullnose profile top ..... 13

LS71: 6R/0 profile top ..... 14

**Solid Surface Series:** Profile edge top, applied .5B/0 profile  
edge backsplash and endsplash ..... 15-20

PS59: 3R/3R profile top ..... 15

PS60: 3R/.5B profile top ..... 15

PS61: 6B/.5B profile top ..... 16

PS62: 6B/6B profile top ..... 16

PS63: 6R/.5B profile top ..... 17

PS64: 6R/6R profile top ..... 17

PS65: 12B/.5B profile top ..... 18

PS66: 12R/.5B profile top ..... 18

PS67: 12R/6R profile top ..... 19

PS68: 12R/12R profile top ..... 19

PS72: .5B/.5B profile top ..... 20

(continued on page 2)



### Table of Contents *(continued)*

<b>Solid Surface Series:</b> Profile edge top, integral covered .5B/0 profile edge backsplash, applied .5B/0 profile edge endsplash .....	<b>21-26</b>
PS79: 3R/3R profile top .....	21
PS80: 3R/.5B profile top .....	21
PS81: 6B/.5B profile top .....	22
PS82: 6B/6B profile top .....	22
PS83: 6R/.5B profile top .....	23
PS84: 6R/6R profile top .....	23
PS85: 12B/.5B profile top .....	24
PS86: 12R/.5B profile top .....	24
PS87: 12R/6R profile top .....	25
PS88: 12R/12R profile top .....	25
PS92: .5B/.5B profile top .....	26
 <b>Epoxy Resin Series:</b> 3mm bevel/radius edges .....	<b>27-28</b>
ES00: Applied backsplash and endsplash .....	27
ES01: Integral covered backsplash, applied endsplash .....	27
ES02: Lipped marine edge top, applied backsplash and endsplash .....	28
ES03: Lipped marine edge top, integral covered backsplash, applied endsplash .....	28
 <b>Hardwood Series</b> .....	<b>29</b>
WD00 .....	29
 <b>Workbench Series</b> .....	<b>30</b>
BW00 .....	30
 <b>Stainless Steel Series</b> .....	<b>31-32</b>
SS00: Formed edge .....	31
SS01: Marine edge .....	32
 <b>Phenolic Series</b> .....	<b>33-35</b>
AP00: Decorative face .....	33
AP01: Black acid resistant face .....	33
AP02: Decorative acid resistant face .....	34
AP03: Decorative face, drip groove .....	34
AP04: Black acid resistant face, drip groove .....	35
AP05: Decorative acid resistant face, drip groove .....	35
 <b>Granite Series:</b> Applied straight polish profile edge backsplash and endsplash .....	<b>36-37</b>
GS00: Straight polish/straight polish profile edge top .....	36
GS01: Bevel ±1/4"/straight polish profile edge top .....	36
GS02: Half bullnose/straight polish profile edge top .....	37

*(continued on page 3)*



Table of Contents *(continued)*

**Marble Series:** Applied straight polish profile edge backsplash and endsplash ..... **38-39**

- MS00: Straight polish/straight polish profile edge top ..... 38
- MS01: Bevel ±1/4"/straight polish profile edge top..... 38
- MS02: Half bullnose/straight polish profile edge top ..... 39

**Quartz Series:** Applied straight polish profile edge backsplash and endsplash ..... **40-41**

- QS00: Straight polish/straight polish profile edge top ..... 40
- QS01: Bevel ±1/4"/straight polish profile edge top..... 40
- QS02: Half bullnose/straight polish profile edge top ..... 41

**WINDOWSILLS**

**Laminate Series**..... **42-44**

- LS50: Self edge ..... 42
- LS51: 90° postform edge ..... 43
- LS52: 180° postform edge ..... 44

**Solid Surface Series**..... **45-46**

- PS10: 3R/3R profile edge ..... 45
- PS11: 3R/.5B profile edge ..... 45
- PS12: 6R/6R profile edge ..... 46
- PS13: .5B/.5B profile edge..... 46

# COUNTERTOPS

Commercial Cabinetry and Millwork







Stevens Industries, Inc., from its initial founding in 1956, has provided a complete solution of cabinets and countertops fabricated and coordinated as a full product offering. Stevens Advantage countertops, included with the wide range of cabinets and millwork, can complete the entire project's requirements. Countertops are available in several versions of laminate, solid surface (polymer), epoxy resin, hardwood, stainless steel, phenolic, granite, marble and quartz. The following technical descriptions and design data illustrate the available designs. Beyond those shown, Stevens Millwork can also provide unique special applications.

### GLOSSARY OF TERMS:

3mm Edge:	Edge with high impact 3mm (1/8") thickness extrusion (patterns available from Stevens standard offering)
90° Postform:	Seamless formed High Pressure Laminate wrapped over a 90° radius profile (eliminates brown edges and separate applied edge strips)
180° Postform:	Seamless formed High Pressure Laminate wrapped over a 180° profile (eliminates brown edges and separate applied edge strips)
Backer:	Back underside faced with laminate backer
CARB:	California Air Resources Board
Chemsurf:	Chemical resistant laminate
HGS:	Horizontal Grade Standard
HPL:	Face surfacing in High Pressure Laminate
Integral Cove:	Backsplash with a concave formed seamless intersection between countertop and backsplash
Marine Edge:	Raised outside countertop edge
MDF:	Medium Density Fiberboard
NAF:	No Added Formaldehyde
Self Edge:	Edges laminated with same High Pressure Laminate as countertop face
TFL:	Thermally Fused Laminate

### COUNTERTOP PREFIX CODES:

AP:	Phenolic	MS:	Marble
BW:	Laminated Workbench	PS:	Solid Surface (Polymer)
ES:	Epoxy Resin	QS:	Quartz
GS:	Granite	SS:	Stainless Steel
LS:	Laminate	WD:	Laminated Hardwood (Butcher Block)

### COUNTERTOP CORE/SUBSTRATE CODES:

C:	CARB particleboard	M:	Moisture-resistant/NAF particleboard
D:	Medium Density Fiberboard (MDF)	P:	Plywood
F:	Fire-rated particleboard	R:	Rail
G:	Moisture-resistant/NAF MDF	S:	Solid
H:	Fire-rated MDF		

# COUNTERTOPS

## Laminate Series

LT = Laminate Top  
LB = Laminate Backsplash  
LE = Laminate Endsplash



### LS00

Example:  
LS00C2721

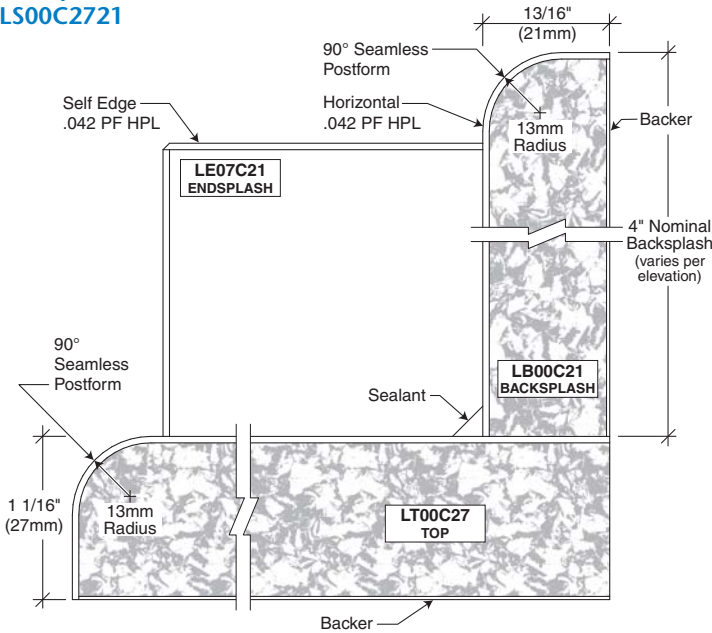

### LS00 LAMINATE

- 90° postform edge top
- Applied 90° postform edge backsplash
- Applied self edge endsplash

#### Series/Core Codes:

- LS00C** CARB particleboard
- LS00M** Moisture-resistant/NAF particleboard
- LS00F** Fire-rated particleboard
- LS00D** Medium Density Fiberboard (MDF)
- LS00G** Moisture-resistant/NAF MDF
- LS00H** Fire-rated MDF

#### LS00C, LS00M, LS00F, LS00D, LS00G and LS00H

available countertop thicknesses:

- 21mm (13/16")
- 27mm (1-1/16")
- 30mm (1-3/16")
- 40mm (1-9/16") (n/a for LS00H fire-rated MDF)

### LS05

Example:  
LS05C2721

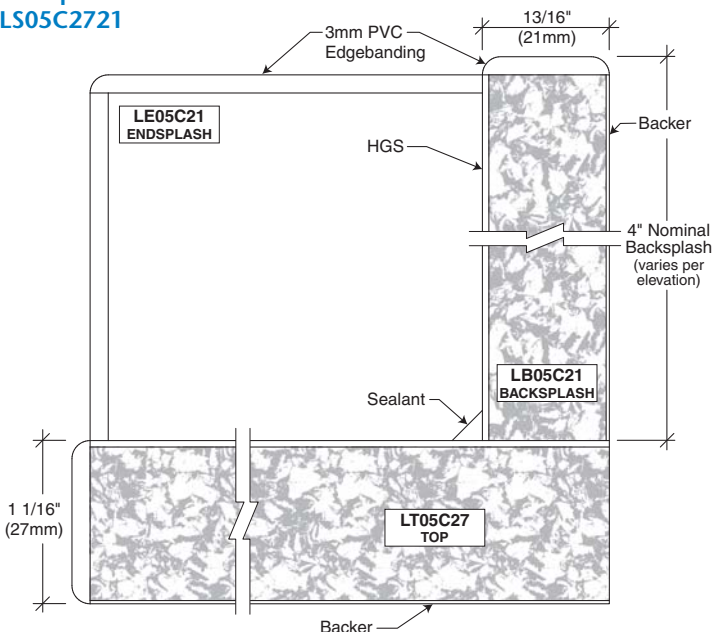

### LS05 LAMINATE

- 3mm edge top
- Applied 3mm edge backsplash and endsplash

#### Series/Core Codes:

- LS05C** CARB particleboard
- LS05M** Moisture-resistant/NAF particleboard
- LS05F** Fire-rated particleboard
- LS05D** Medium Density Fiberboard (MDF)
- LS05G** Moisture-resistant/NAF MDF
- LS05H** Fire-rated MDF
- LS05P** Plywood

#### LS05C, LS05M, LS05F, LS05D, LS05G and LS05H

available countertop thicknesses:

- 21mm (13/16")
- 27mm (1-1/16")
- 30mm (1-3/16")
- 40mm (1-9/16")\* (n/a for LS05H fire-rated MDF)

**LS05P** available countertop thicknesses:

- 20mm (3/4")
- 27mm (1-1/16")
- 40mm (1-9/16")\*

\*edges: specific patterns only

LT = Laminate Top  
LB = Laminate Backsplash  
LE = Laminate Endsplash

### LS07

Example:  
LS07C2721

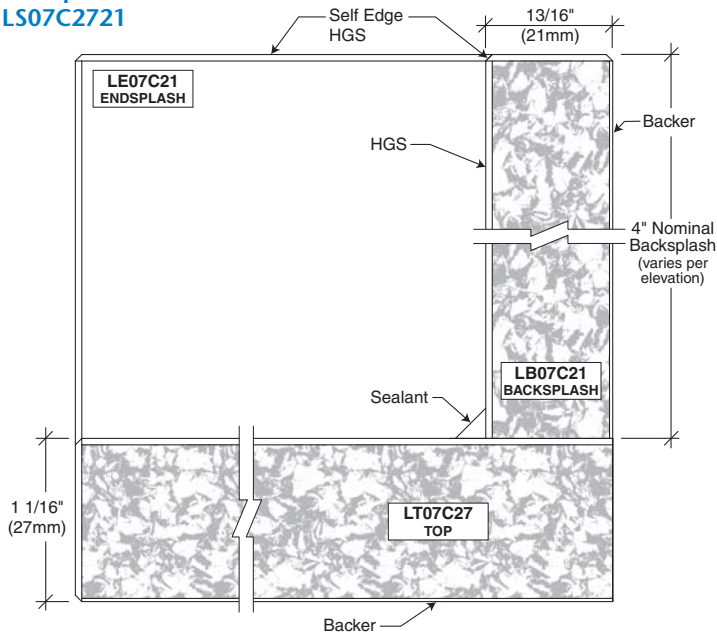

### LS07 LAMINATE

- Self edge top
- Applied self edge backsplash and endsplash

#### Series/Core Codes:

**LS07C** CARB particleboard  
**LS07M** Moisture-resistant/NAF particleboard  
**LS07F** Fire-rated particleboard  
**LS07D** Medium Density Fiberboard (MDF)  
**LS07G** Moisture-resistant/NAF MDF  
**LS07H** Fire-rated MDF  
**LS07P** Plywood

**LS07C, LS07M, LS07F, LS07D, LS07G and LS07H** available countertop thicknesses:

21mm (13/16")  
27mm (1-1/16")  
30mm (1-3/16")  
40mm (1-9/16") (n/a for LS07H fire-rated MDF)

**LS07P** available countertop thicknesses:

20mm (3/4")  
27mm (1-1/16")  
40mm (1-9/16")

### LS10

Example:  
LS10C2721

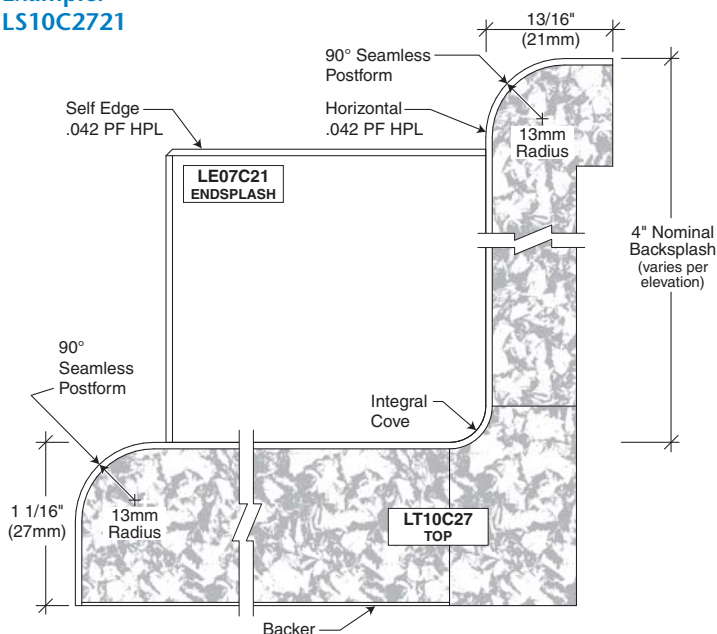

### LS10 LAMINATE

- 90° postform edge top
- Integral covered 90° postform edge backsplash
- Applied self edge endsplash

#### Series/Core Codes:

**LS10C** CARB particleboard  
**LS10M** Moisture-resistant/NAF particleboard  
**LS10F** Fire-rated particleboard  
**LS10D** Medium Density Fiberboard (MDF)  
**LS10G** Moisture-resistant/NAF MDF  
**LS10H** Fire-rated MDF

**LS10C, LS10M, LS10F, LS10D, LS10G and LS10H** available countertop thicknesses:

21mm (13/16")  
27mm (1-1/16")  
30mm (1-3/16")  
40mm (1-9/16") (n/a for LS10H fire-rated MDF)

# COUNTERTOPS

## Laminate Series

LT = Laminate Top  
 LB = Laminate Backsplash  
 LE = Laminate Endsplash



### LS11

Example:  
 LS11C2721

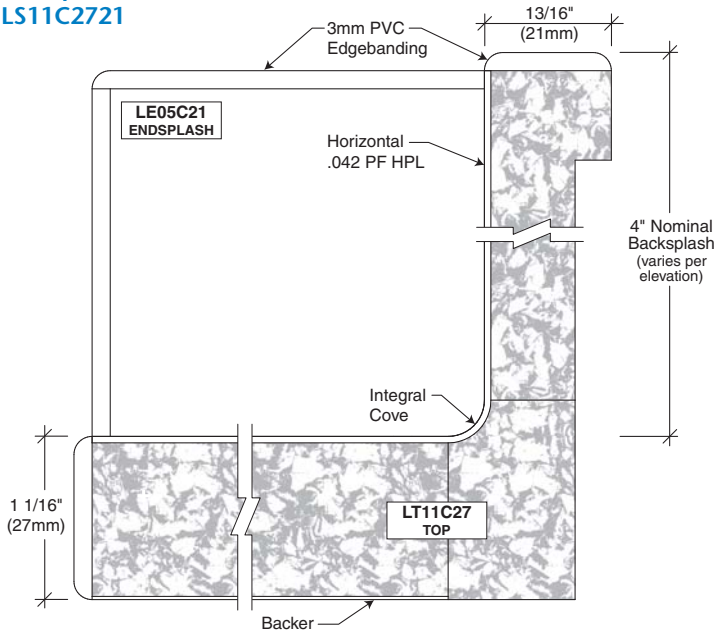

### LS11 LAMINATE

- 3mm edge top
- Integral coved 3mm edge backsplash
- Applied 3mm edge endsplash

#### Series/Core Codes:

- LS11C** CARB particleboard
- LS11M** Moisture-resistant/NAF particleboard
- LS11F** Fire-rated particleboard
- LS11D** Medium Density Fiberboard (MDF)
- LS11G** Moisture-resistant/NAF MDF
- LS11H** Fire-rated MDF
- LS11P** Plywood

#### LS11C, LS11M, LS11F, LS11D, LS11G and LS11H

available countertop thicknesses:

- 21mm (13/16")
- 27mm (1-1/16")
- 30mm (1-3/16")
- 40mm (1-9/16")\* (n/a for LS11H fire-rated MDF)

**LS11P** available countertop thicknesses:

- 20mm (3/4")
- 27mm (1-1/16")
- 40mm (1-9/16")\*

\*edges: specific patterns only

### LS15

Example:  
 LS15C2721

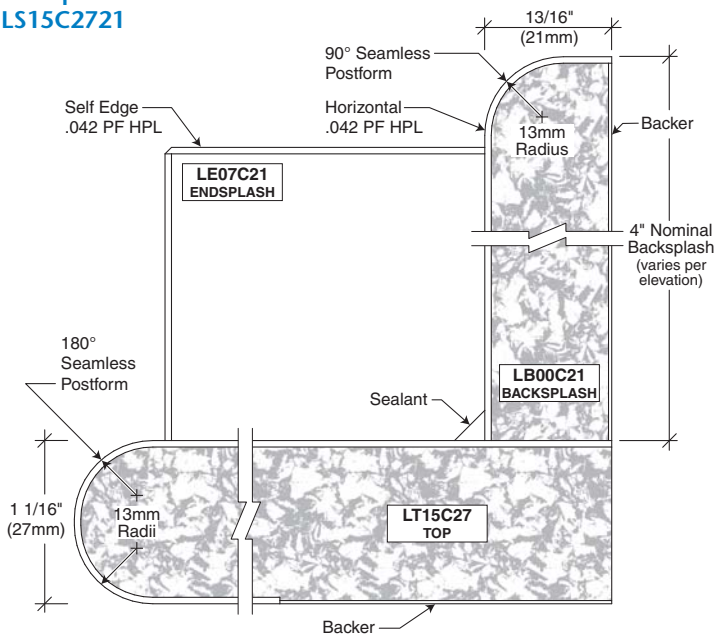

### LS15 LAMINATE

- 180° postform edge top
- Applied 90° postform edge backsplash
- Applied self edge endsplash

#### Series/Core Codes:

- LS15C** CARB particleboard
- LS15M** Moisture-resistant/NAF particleboard
- LS15F** Fire-rated particleboard
- LS15D** Medium Density Fiberboard (MDF)
- LS15G** Moisture-resistant/NAF MDF
- LS15H** Fire-rated MDF

#### LS15C, LS15M, LS15F, LS15D, LS15G and LS15H

- available countertop thicknesses:
- 21mm (13/16")
  - 27mm (1-1/16")
  - 30mm (1-3/16")
  - 40mm (1-9/16") (n/a for LS15H fire-rated MDF)

LT = Laminate Top  
LB = Laminate Backsplash  
LE = Laminate Endsplash

### LS16

Example:  
LS16C2721

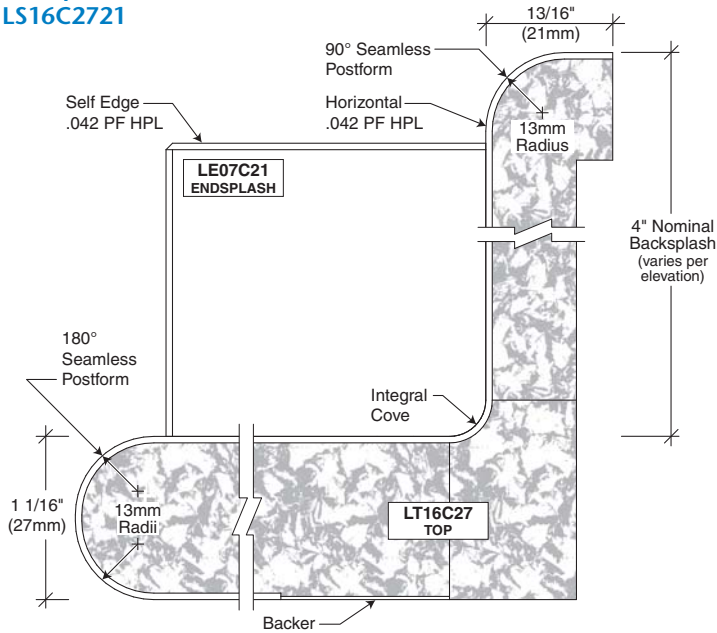

### LS16 LAMINATE

- 180° postform edge top
- Integral cove 90° postform edge backsplash
- Applied self edge endsplash

### Series/Core Codes:

- LS16C** CARB particleboard
- LS16M** Moisture-resistant/NAF particleboard
- LS16F** Fire-rated particleboard
- LS16D** Medium Density Fiberboard (MDF)
- LS16G** Moisture-resistant/NAF MDF
- LS16H** Fire-rated MDF

**LS16C, LS16M, LS16F, LS16D, LS16G and LS16H**  
available countertop thicknesses:

- ~~21mm (13/16")~~
- 27mm (1-1/16")
- 30mm (1-3/16")
- 40mm (1-9/16") (n/a for LS16H fire-rated MDF)



# COUNTERTOPS

Laminate Series  
Chemsurf

LT = Laminate Top  
LB = Laminate Backsplash  
LE = Laminate Endsplash



## LS25

Example:  
LS25C2721

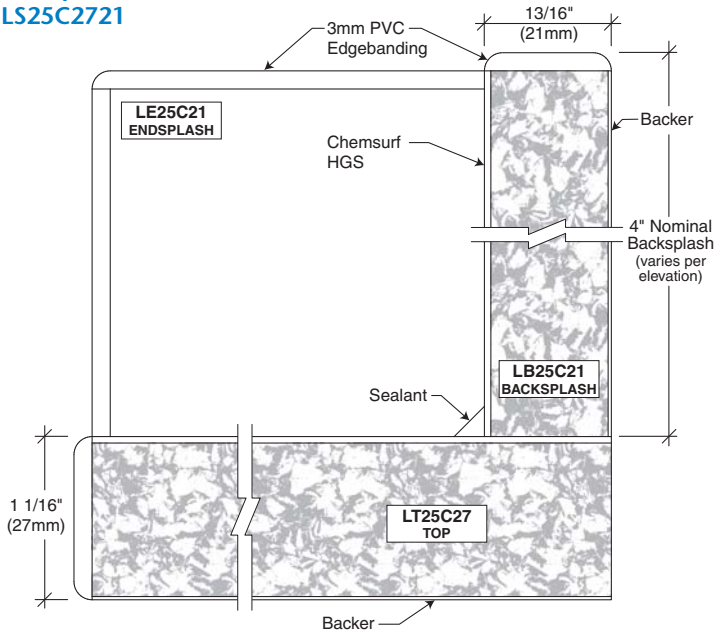

### LS25 LAMINATE

- Chemsurf face laminate
- 3mm edge top
- Applied 3mm edge backsplash and endsplash

#### Series/Core Codes:

- LS25C** CARB particleboard
- LS25M** Moisture-resistant/NAF particleboard
- LS25F** Fire-rated particleboard
- LS25D** Medium Density Fiberboard (MDF)
- LS25G** Moisture-resistant/NAF MDF
- LS25H** Fire-rated MDF
- LS25P** Plywood

**LS25C, LS25M, LS25F, LS25D, LS25G and LS25H** available countertop thicknesses:

- 21mm (13/16")
- 27mm (1-1/16")
- 30mm (1-3/16")
- 40mm (1-9/16")\* (n/a for LS25H fire-rated MDF)

**LS25P** available countertop thicknesses:

- 20mm (3/4")
- 27mm (1-1/16")
- 40mm (1-9/16")\*

\*edges: specific patterns only

## LS26

Example:  
LS26C2721

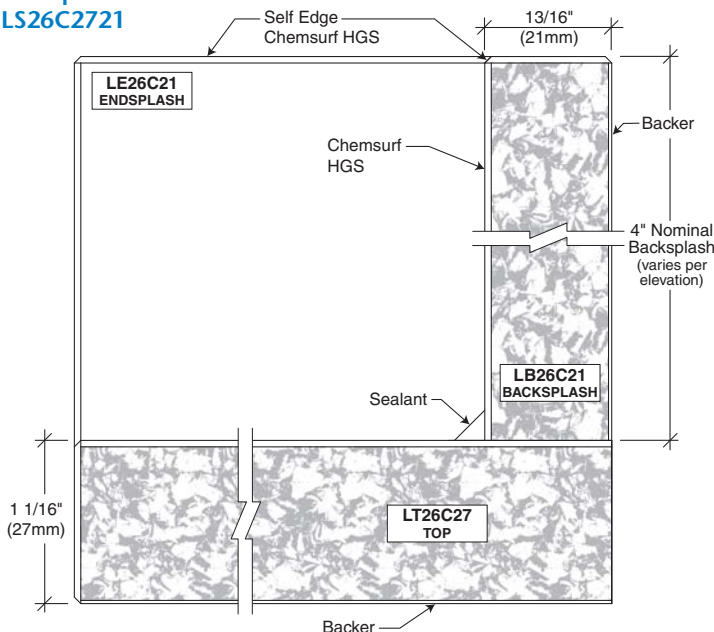

### LS26 LAMINATE

- Chemsurf face laminate
- Self edge top
- Applied self edge backsplash and endsplash

#### Series/Core Codes:

- LS26C** CARB particleboard
- LS26M** Moisture-resistant/NAF particleboard
- LS26F** Fire-rated particleboard
- LS26D** Medium Density Fiberboard (MDF)
- LS26G** Moisture-resistant/NAF MDF
- LS26H** Fire-rated MDF
- LS26P** Plywood

**LS26C, LS26M, LS26F, LS26D, LS26G and LS26H** available countertop thicknesses:

- 21mm (13/16")
- 27mm (1-1/16")
- 30mm (1-3/16")
- 40mm (1-9/16") (n/a for LS26H fire-rated MDF)

**LS26P** available countertop thicknesses:

- 20mm (3/4")
- 27mm (1-1/16")
- 40mm (1-9/16")

LT = Laminate Top  
LB = Laminate Backsplash  
LE = Laminate Endsplash

### LS60

(Stevens preferred)

Example:  
LS60C2721

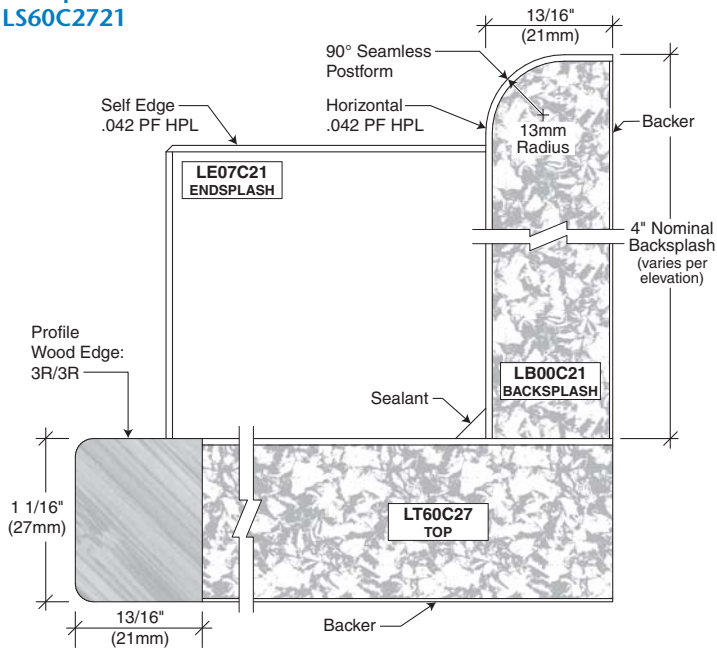

### LS60 LAMINATE WITH WOOD EDGE

- 3R/3R profile wood edge top
- Applied 90° postform edge backsplash
- Applied self edge endsplash

#### Series/Core Codes:

- LS60C** CARB particleboard
- LS60M** Moisture-resistant/NAF particleboard
- LS60F** Fire-rated particleboard
- LS60D** Medium Density Fiberboard (MDF)
- LS60G** Moisture-resistant/NAF MDF
- LS60H** Fire-rated MDF

**LS60C, LS60M, LS60F, LS60D, LS60G and LS60H** available countertop thicknesses:

- 21mm (13/16")
- 27mm (1-1/16")
- 30mm (1-3/16")
- 40mm (1-9/16") (n/a for LS60H fire-rated MDF)

**Wood Edge** available species and finishes:

- Species: maple, red oak, cherry
- Finishes: Stevens current standards

### LS64

Example:  
LS64C2721

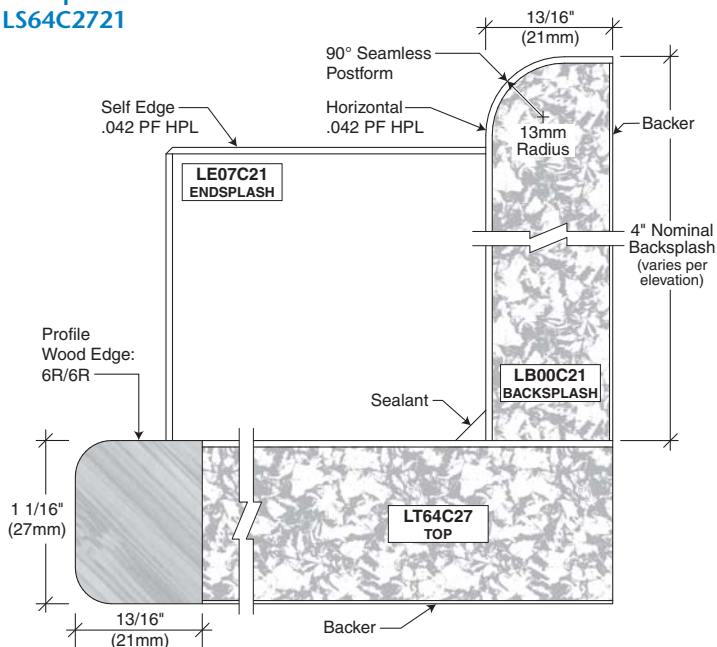

### LS64 LAMINATE WITH WOOD EDGE

- 6R/6R profile wood edge top
- Applied 90° postform edge backsplash
- Applied self edge endsplash

#### Series/Core Codes:

- LS64C** CARB particleboard
- LS64M** Moisture-resistant/NAF particleboard
- LS64F** Fire-rated particleboard
- LS64D** Medium Density Fiberboard (MDF)
- LS64G** Moisture-resistant/NAF MDF
- LS64H** Fire-rated MDF

**LS64C, LS64M, LS64F, LS64D, LS64G and LS64H** available countertop thicknesses:

- 21mm (13/16")
- 27mm (1-1/16")
- 30mm (1-3/16")
- 40mm (1-9/16") (n/a for LS64H fire-rated MDF)

**Wood Edge** available species and finishes:

- Species: maple, red oak, cherry
- Finishes: Stevens current standards



# COUNTERTOPS

## Laminate Series Wood Edge Top

LT = Laminate Top  
LB = Laminate Backsplash  
LE = Laminate Endsplash



### LS65

Example:  
LS65C2721

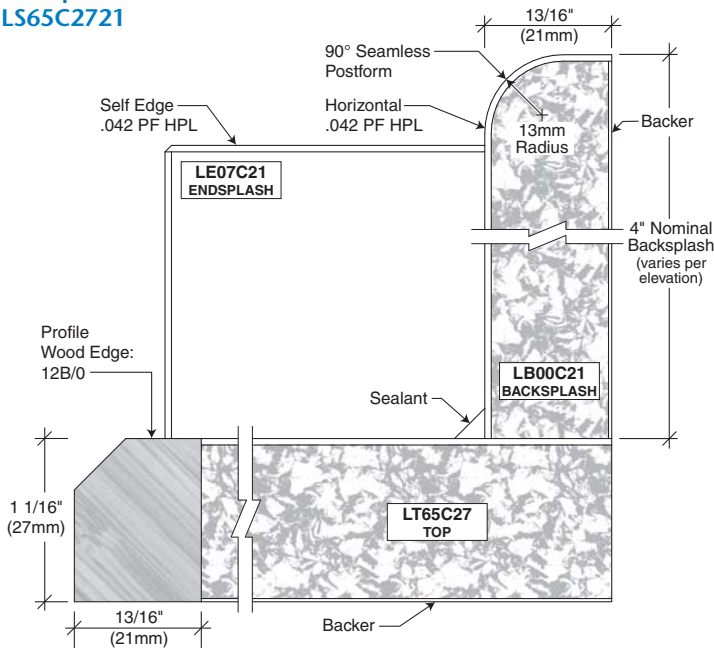

### LS65 LAMINATE WITH WOOD EDGE

- 12B/0 profile wood edge top
- Applied 90° postform edge backsplash
- Applied self edge endsplash

#### Series/Core Codes:

- LS65C** CARB particleboard
- LS65M** Moisture-resistant/NAF particleboard
- LS65F** Fire-rated particleboard
- LS65D** Medium Density Fiberboard (MDF)
- LS65G** Moisture-resistant/NAF MDF
- LS65H** Fire-rated MDF

**LS65C, LS65M, LS65F, LS65D, LS65G and LS65H** available countertop thicknesses:

- 21mm (13/16")
- 27mm (1-1/16")
- 30mm (1-3/16")
- 40mm (1-9/16") (n/a for LS65H fire-rated MDF)

**Wood Edge** available species and finishes:

- Species: maple, red oak, cherry
- Finishes: Stevens current standards

### LS67

Example:  
LS67C2721

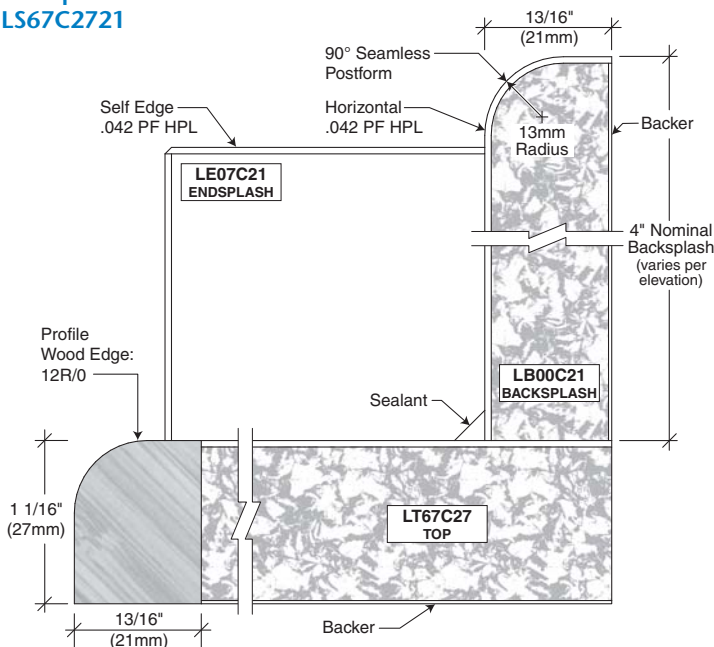

### LS67 LAMINATE WITH WOOD EDGE

- 12R/0 profile wood edge top
- Applied 90° postform edge backsplash
- Applied self edge endsplash

#### Series/Core Codes:

- LS67C** CARB particleboard
- LS67M** Moisture-resistant/NAF particleboard
- LS67F** Fire-rated particleboard
- LS67D** Medium Density Fiberboard (MDF)
- LS67G** Moisture-resistant/NAF MDF
- LS67H** Fire-rated MDF

**LS67C, LS67M, LS67F, LS67D, LS67G and LS67H** available countertop thicknesses:

- 21mm (13/16")
- 27mm (1-1/16")
- 30mm (1-3/16")
- 40mm (1-9/16") (n/a for LS67H fire-rated MDF)

**Wood Edge** available species and finishes:

- Species: maple, red oak, cherry
- Finishes: Stevens current standards

LT = Laminate Top  
LB = Laminate Backsplash  
LE = Laminate Endsplash

## LS68

Example:  
LS68C2721

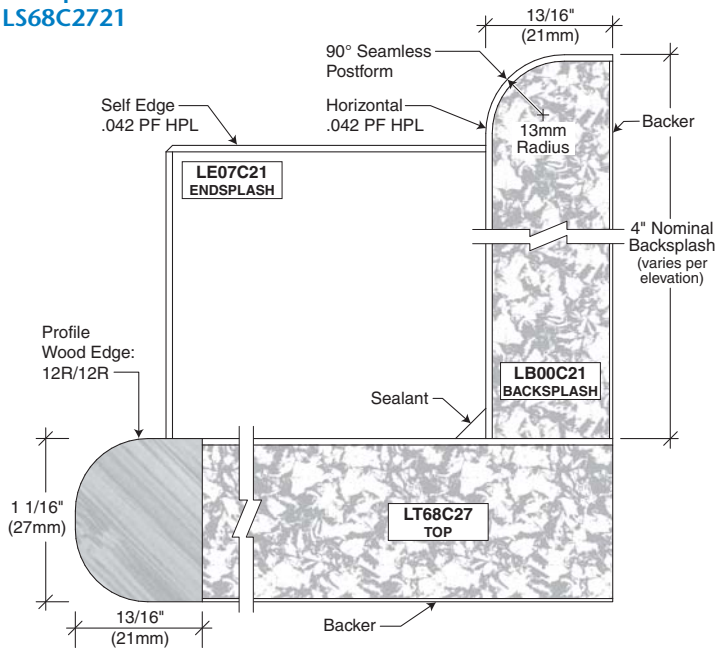

### LS68 LAMINATE WITH WOOD EDGE

- 12R/12R profile wood edge top
- Applied 90° postform edge backsplash
- Applied self edge endsplash

#### Series/Core Codes:

- LS68C** CARB particleboard  
**LS68M** Moisture-resistant/NAF particleboard  
**LS68F** Fire-rated particleboard  
**LS68D** Medium Density Fiberboard (MDF)  
**LS68G** Moisture-resistant/NAF MDF  
**LS68H** Fire-rated MDF

**LS68C, LS68M, LS68F, LS68D, LS68G and LS68H** available countertop thicknesses:

- 27mm (1-1/16")
- 30mm (1-3/16")
- 40mm (1-9/16") (n/a for LS68H fire-rated MDF)

**Wood Edge** available species and finishes:

- Species: maple, red oak, cherry
- Finishes: Stevens current standards

## LS70

Example:  
LS70C2721

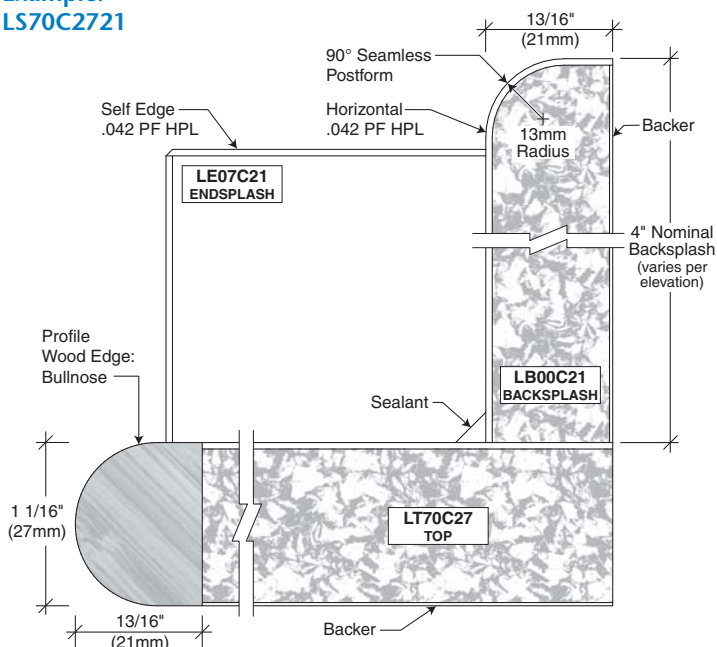

### LS70 LAMINATE WITH WOOD EDGE

- Bullnose profile wood edge top
- Applied 90° postform edge backsplash
- Applied self edge endsplash

#### Series/Core Codes:

- LS70C** CARB particleboard  
**LS70M** Moisture-resistant/NAF particleboard  
**LS70F** Fire-rated particleboard  
**LS70D** Medium Density Fiberboard (MDF)  
**LS70G** Moisture-resistant/NAF MDF  
**LS70H** Fire-rated MDF

**LS70C, LS70M, LS70F, LS70D, LS70G and LS70H** available countertop thicknesses:

- 21mm (13/16")
- 27mm (1-1/16")
- 30mm (1-3/16")

**Wood Edge** available species and finishes:

- Species: maple, red oak, cherry
- Finishes: Stevens current standards

# COUNTERTOPS

## Laminate Series Wood Edge Top

LT = Laminate Top  
LB = Laminate Backsplash  
LE = Laminate Endsplash



### LS71

Example:  
LS71C2721

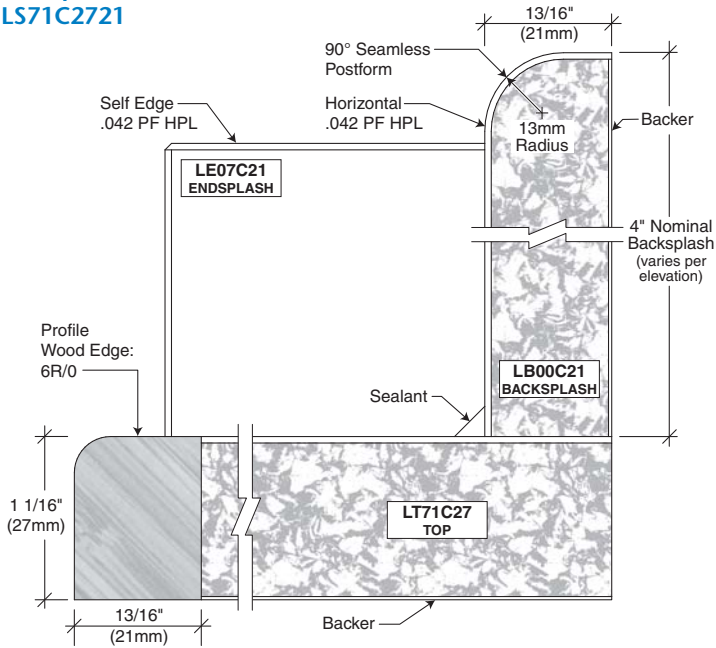

### LS71 LAMINATE WITH WOOD EDGE

- 6R/0 profile wood edge top
- Applied 90° postform edge backsplash
- Applied self edge endsplash

#### Series/Core Codes:

- LS71C** CARB particleboard
- LS71M** Moisture-resistant/NAF particleboard
- LS71F** Fire-rated particleboard
- LS71D** Medium Density Fiberboard (MDF)
- LS71G** Moisture-resistant/NAF MDF
- LS71H** Fire-rated MDF

#### LS71C, LS71M, LS71F, LS71D, LS71G and LS71H available countertop thicknesses:

- 21mm (13/16")
- 27mm (1-1/16")
- 30mm (1-3/16")
- 40mm (1-9/16") (n/a for LS71H fire-rated MDF)

#### Wood Edge available species and finishes:

- Species: maple, red oak, cherry
- Finishes: Stevens current standards

**PT = Solid Surface Top**  
**PB = Solid Surface Backsplash**  
**PE = Solid Surface Endsplash**

### PS59

(Stevens preferred)

Example:

**PS59C2912**

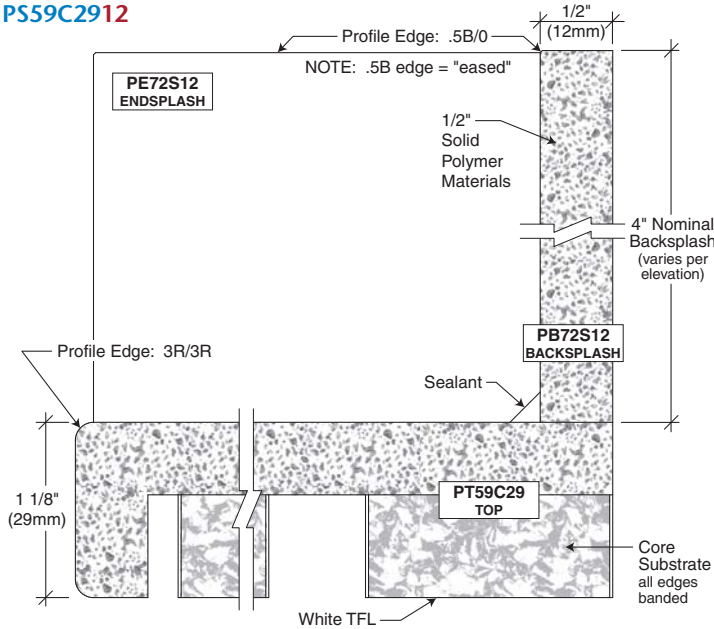

### PS59 SOLID SURFACE

- Solid surface (polymer) materials
- 3R/3R profile edge top
- Applied .5B/0 profile edge backsplash and endsplash

#### Series/Core Substrate Codes:

- PS59C** CARB particleboard  
**PS59M** Moisture-resistant/NAF particleboard  
**PS59F** Fire-rated particleboard  
**PS59D** Medium Density Fiberboard (MDF)  
**PS59G** Moisture-resistant/NAF MDF  
**PS59H** Fire-rated MDF  
**PS59P** Plywood

#### Backsplash and Endsplash Model/Core Codes:

- PB72S** Solid  
**PE72S** Solid

**PS59C, PS59M, PS59F, PS59D, PS59G, PS59H** and **PS59P** available countertop thicknesses:

- 29mm (1-1/8")  
38mm (1-1/2")

*Drop edge available upon special request in 1/2" increments, from 2" to 6". Drop edge not available over casework.*

### PS60

Example:

**PS60C2912**

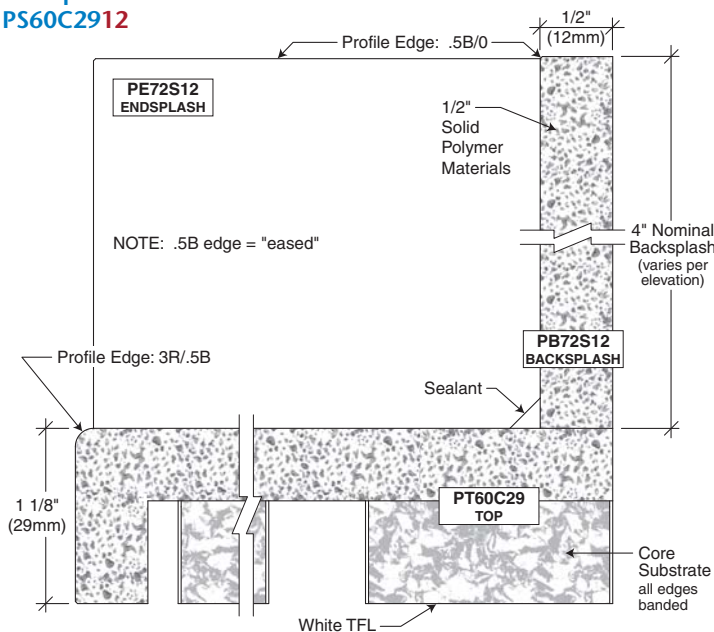

### PS60 SOLID SURFACE

- Solid surface (polymer) materials
- 3R/.5B profile edge top
- Applied .5B/0 profile edge backsplash and endsplash

#### Series/Core Substrate Codes:

- PS60C** CARB particleboard  
**PS60M** Moisture-resistant/NAF particleboard  
**PS60F** Fire-rated particleboard  
**PS60D** Medium Density Fiberboard (MDF)  
**PS60G** Moisture-resistant/NAF MDF  
**PS60H** Fire-rated MDF  
**PS60P** Plywood

#### Backsplash and Endsplash Model/Core Codes:

- PB72S** Solid  
**PE72S** Solid

**PS60C, PS60M, PS60F, PS60D, PS60G, PS60H** and **PS60P** available countertop thicknesses:

- 29mm (1-1/8")  
38mm (1-1/2")

*Drop edge available upon special request in 1/2" increments, from 2" to 6". Drop edge not available over casework.*

# COUNTERTOPS

## Solid Surface Series

PT = Solid Surface Top  
 PB = Solid Surface Backsplash  
 PE = Solid Surface Endsplash



### PS61

Example:  
 PS61C2912

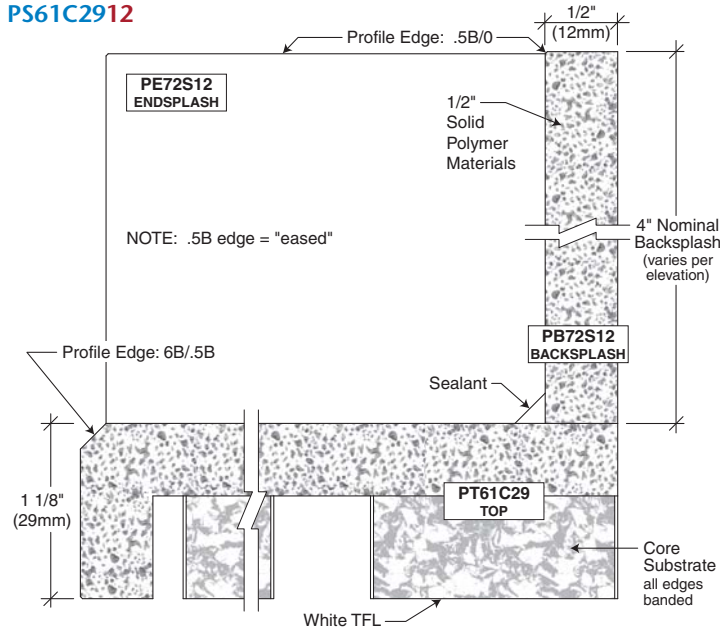

### PS61 SOLID SURFACE

- Solid surface (polymer) materials
- 6B/.5B profile edge top
- Applied .5B/0 profile edge backsplash and endsplash

#### Series/Core Substrate Codes:

- PS61C** CARB particleboard
- PS61M** Moisture-resistant/NAF particleboard
- PS61F** Fire-rated particleboard
- PS61D** Medium Density Fiberboard (MDF)
- PS61G** Moisture-resistant/NAF MDF
- PS61H** Fire-rated MDF
- PS61P** Plywood

#### Backsplash and Endsplash Model/Core Codes:

- PB72S** Solid
- PE72S** Solid

**PS61C, PS61M, PS61F, PS61D, PS61G, PS61H** and **PS61P** available countertop thicknesses:

- 29mm (1-1/8")
- 38mm (1-1/2")

*Drop edge available upon special request in 1/2" increments, from 2" to 6". Drop edge not available over casework.*

### PS62

Example:  
 PS62C2912

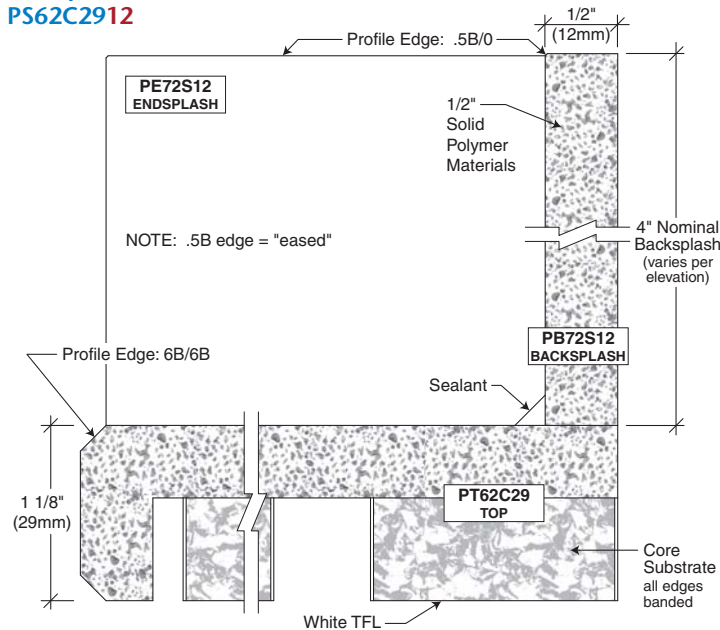

### PS62 SOLID SURFACE

- Solid surface (polymer) materials
- 6B/6B profile edge top
- Applied .5B/0 profile edge backsplash and endsplash

#### Series/Core Substrate Codes:

- PS62C** CARB particleboard
- PS62M** Moisture-resistant/NAF particleboard
- PS62F** Fire-rated particleboard
- PS62D** Medium Density Fiberboard (MDF)
- PS62G** Moisture-resistant/NAF MDF
- PS62H** Fire-rated MDF
- PS62P** Plywood

#### Backsplash and Endsplash Model/Core Codes:

- PB72S** Solid
- PE72S** Solid

**PS62C, PS62M, PS62F, PS62D, PS62G, PS62H** and **PS62P** available countertop thicknesses:

- 29mm (1-1/8")
- 38mm (1-1/2")

*Drop edge available upon special request in 1/2" increments, from 2" to 6". Drop edge not available over casework.*



**PT = Solid Surface Top**  
**PB = Solid Surface Backsplash**  
**PE = Solid Surface Endsplash**

### PS63

Example:  
**PS63C2912**

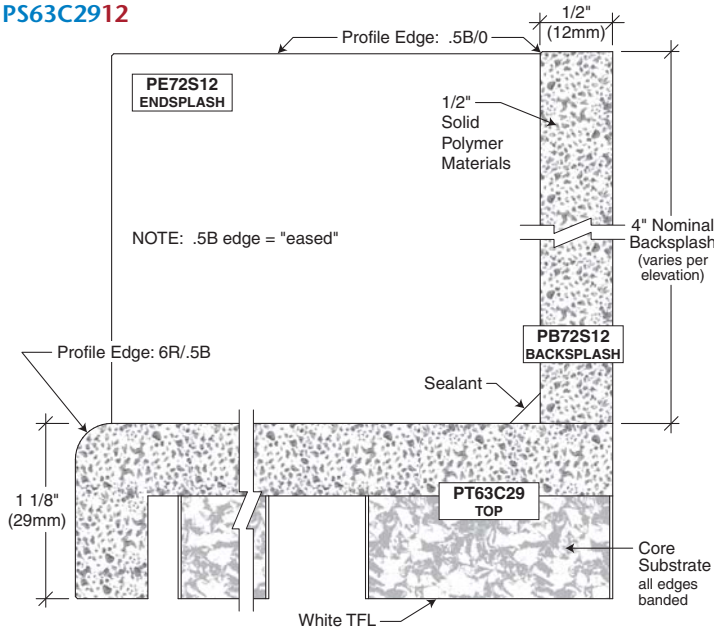

### PS63 SOLID SURFACE

- Solid surface (polymer) materials
- 6R/.5B profile edge top
- Applied .5B/0 profile edge backsplash and endsplash

#### Series/Core Substrate Codes:

- PS63C** CARB particleboard  
**PS63M** Moisture-resistant/NAF particleboard  
**PS63F** Fire-rated particleboard  
**PS63D** Medium Density Fiberboard (MDF)  
**PS63G** Moisture-resistant/NAF MDF  
**PS63H** Fire-rated MDF  
**PS63P** Plywood

#### Backsplash and Endsplash Model/Core Codes:

- PB72S** Solid  
**PE72S** Solid

**PS63C, PS63M, PS63F, PS63D, PS63G, PS63H** and **PS63P** available countertop thicknesses:  
 29mm (1-1/8")  
 38mm (1-1/2")

*Drop edge available upon special request in 1/2" increments, from 2" to 6". Drop edge not available over casework.*

### PS64

Example:  
**PS64C2912**

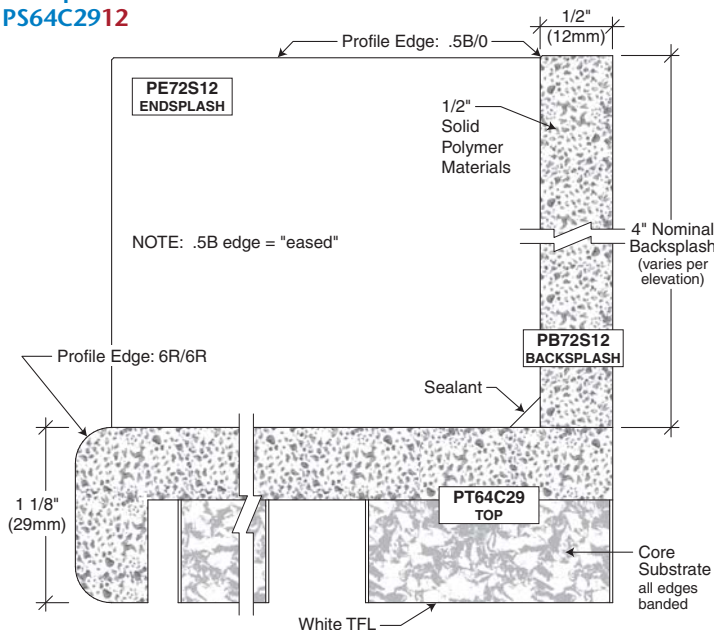

### PS64 SOLID SURFACE

- Solid surface (polymer) materials
- 6R/6R profile edge top
- Applied .5B/0 profile edge backsplash and endsplash

#### Series/Core Substrate Codes:

- PS64C** CARB particleboard  
**PS64M** Moisture-resistant/NAF particleboard  
**PS64F** Fire-rated particleboard  
**PS64D** Medium Density Fiberboard (MDF)  
**PS64G** Moisture-resistant/NAF MDF  
**PS64H** Fire-rated MDF  
**PS64P** Plywood

#### Backsplash and Endsplash Model/Core Codes:

- PB72S** Solid  
**PE72S** Solid

**PS64C, PS64M, PS64F, PS64D, PS64G, PS64H** and **PS64P** available countertop thicknesses:  
 29mm (1-1/8")  
 38mm (1-1/2")

*Drop edge available upon special request in 1/2" increments, from 2" to 6". Drop edge not available over casework.*

# COUNTERTOPS

## Solid Surface Series

PT = Solid Surface Top  
 PB = Solid Surface Backsplash  
 PE = Solid Surface Endsplash



### PS65

Example:  
 PS65C2912

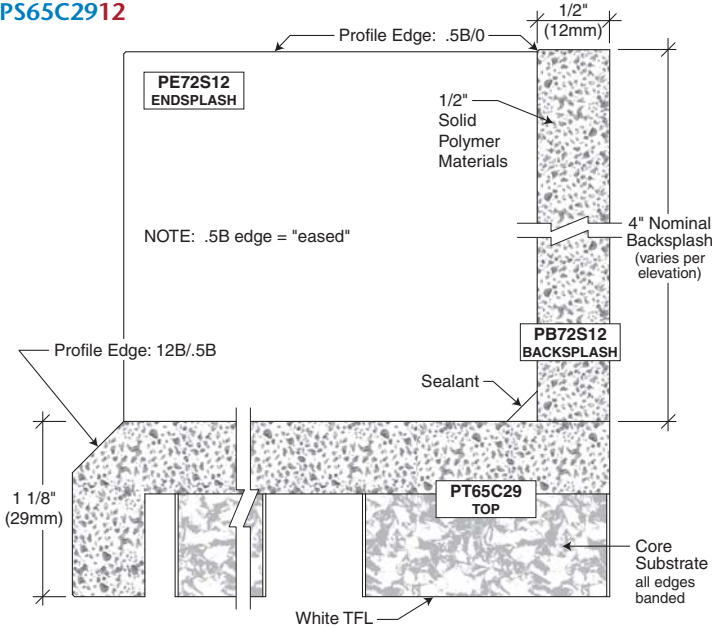

### PS65 SOLID SURFACE

- Solid surface (polymer) materials
- 12B/.5B profile edge top
- Applied .5B/0 profile edge backsplash and endsplash

#### Series/Core Substrate Codes:

- PS65C** CARB particleboard
- PS65M** Moisture-resistant/NAF particleboard
- PS65F** Fire-rated particleboard
- PS65D** Medium Density Fiberboard (MDF)
- PS65G** Moisture-resistant/NAF MDF
- PS65H** Fire-rated MDF
- PS65P** Plywood

#### Backsplash and Endsplash Model/Core Codes:

- PB72S** Solid
- PE72S** Solid

**PS65C, PS65M, PS65F, PS65D, PS65G, PS65H** and **PS65P** available countertop thicknesses:

- 29mm (1-1/8")
- 38mm (1-1/2")

*Drop edge available upon special request in 1/2" increments, from 2" to 6". Drop edge not available over casework.*

### PS66

Example:  
 PS66C2912

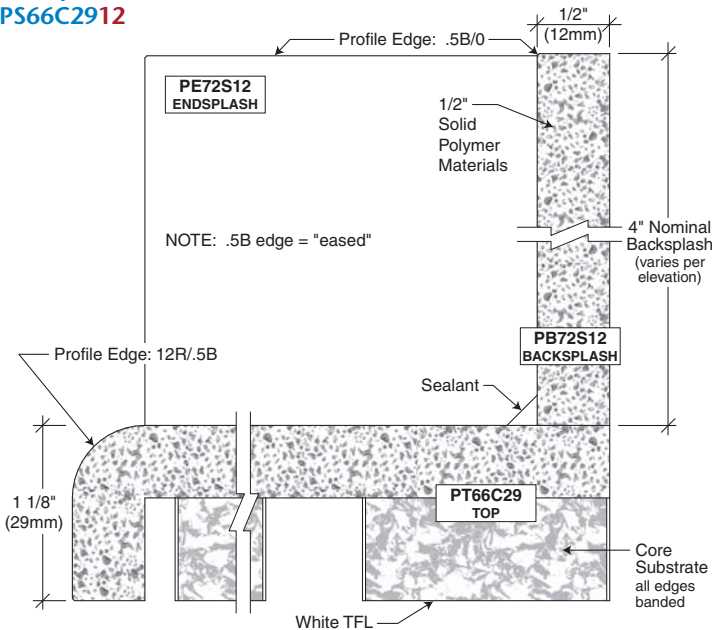

### PS66 SOLID SURFACE

- Solid surface (polymer) materials
- 12R/.5B profile edge top
- Applied .5B/0 profile edge backsplash and endsplash

#### Series/Core Substrate Codes:

- PS66C** CARB particleboard
- PS66M** Moisture-resistant/NAF particleboard
- PS66F** Fire-rated particleboard
- PS66D** Medium Density Fiberboard (MDF)
- PS66G** Moisture-resistant/NAF MDF
- PS66H** Fire-rated MDF
- PS66P** Plywood

#### Backsplash and Endsplash Model/Core Codes:

- PB72S** Solid
- PE72S** Solid

**PS66C, PS66M, PS66F, PS66D, PS66G, PS66H** and **PS66P** available countertop thicknesses:

- 29mm (1-1/8")
- 38mm (1-1/2")

*Drop edge available upon special request in 1/2" increments, from 2" to 6". Drop edge not available over casework.*



**PT = Solid Surface Top**  
**PB = Solid Surface Backsplash**  
**PE = Solid Surface Endsplash**

### PS67

Example:  
**PS67C2912**

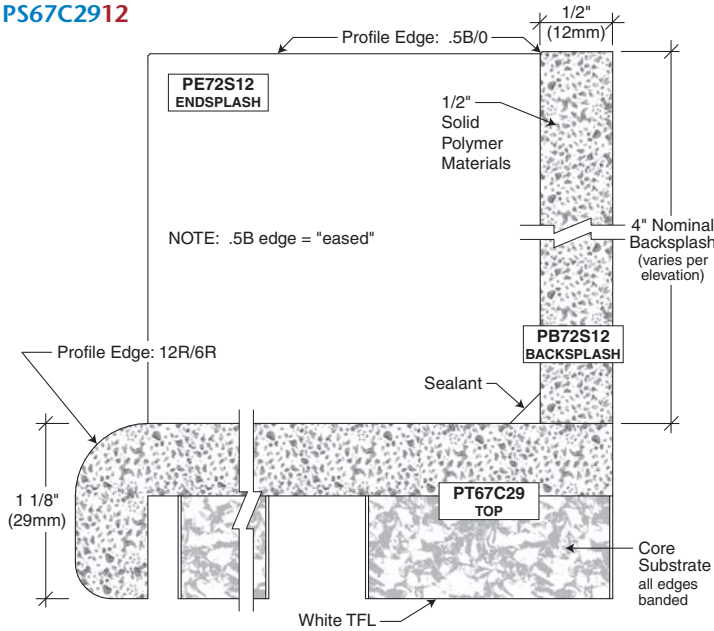

### PS67 SOLID SURFACE

- Solid surface (polymer) materials
- 12R/6R profile edge top
- Applied .5B/0 profile edge backsplash and endsplash

#### Series/Core Substrate Codes:

- PS67C** CARB particleboard  
**PS67M** Moisture-resistant/NAF particleboard  
**PS67F** Fire-rated particleboard  
**PS67D** Medium Density Fiberboard (MDF)  
**PS67G** Moisture-resistant/NAF MDF  
**PS67H** Fire-rated MDF  
**PS67P** Plywood

#### Backsplash and Endsplash Model/Core Codes:

- PB72S** Solid  
**PE72S** Solid

**PS67C, PS67M, PS67F, PS67D, PS67G, PS67H** and **PS67P** available countertop thicknesses:

- 29mm (1-1/8")  
 38mm (1-1/2")

*Drop edge available upon special request in 1/2" increments, from 2" to 6". Drop edge not available over casework.*

### PS68

Example:  
**PS68C2912**

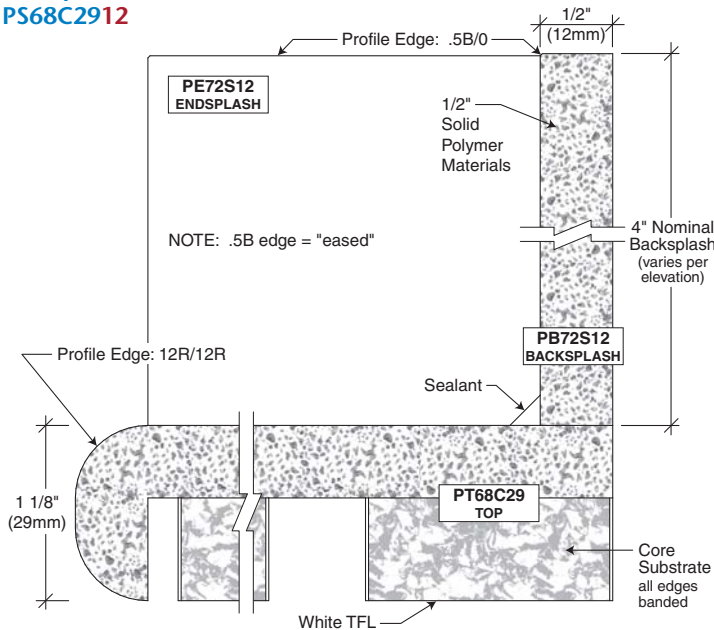

### PS68 SOLID SURFACE

- Solid surface (polymer) materials
- 12R/12R profile edge top
- Applied .5B/0 profile edge backsplash and endsplash

#### Series/Core Substrate Codes:

- PS68C** CARB particleboard  
**PS68M** Moisture-resistant/NAF particleboard  
**PS68F** Fire-rated particleboard  
**PS68D** Medium Density Fiberboard (MDF)  
**PS68G** Moisture-resistant/NAF MDF  
**PS68H** Fire-rated MDF  
**PS68P** Plywood

#### Backsplash and Endsplash Model/Core Codes:

- PB72S** Solid  
**PE72S** Solid

**PS68C, PS68M, PS68F, PS68D, PS68G, PS68H** and **PS68P** available countertop thicknesses:

- 29mm (1-1/8")  
 38mm (1-1/2")

*Drop edge available upon special request in 1/2" increments, from 2" to 6". Drop edge not available over casework.*

# COUNTERTOPS

## Solid Surface Series

PT = Solid Surface Top  
 PB = Solid Surface Backsplash  
 PE = Solid Surface Endsplash



### PS72

Example:  
 PS72C2912

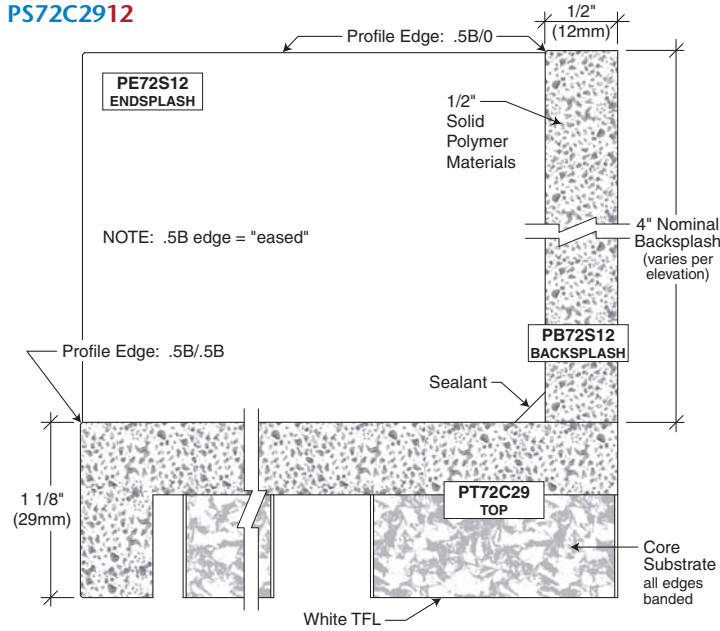

### PS72 SOLID SURFACE

- Solid surface (polymer) materials
- .5B/.5B profile edge top
- Applied .5B/0 profile edge backsplash and endsplash

#### Series/Core Substrate Codes:

- PS72C** CARB particleboard  
**PS72M** Moisture-resistant/NAF particleboard  
**PS72F** Fire-rated particleboard  
**PS72D** Medium Density Fiberboard (MDF)  
**PS72G** Moisture-resistant/NAF MDF  
**PS72H** Fire-rated MDF  
**PS72P** Plywood

#### Backsplash and Endsplash Model/Core Codes:

- PB72S** Solid  
**PE72S** Solid

**PS72C, PS72M, PS72F, PS72D, PS72G, PS72H** and **PS72P** available countertop thicknesses:

- 29mm (1-1/8")  
 38mm (1-1/2")

*Drop edge available upon special request in 1/2" increments, from 2" to 6". Drop edge not available over casework.*

**PT = Solid Surface Top**  
**PE = Solid Surface Endsplash**

### PS79

(Stevens preferred)

Example:

**PS79C2912**

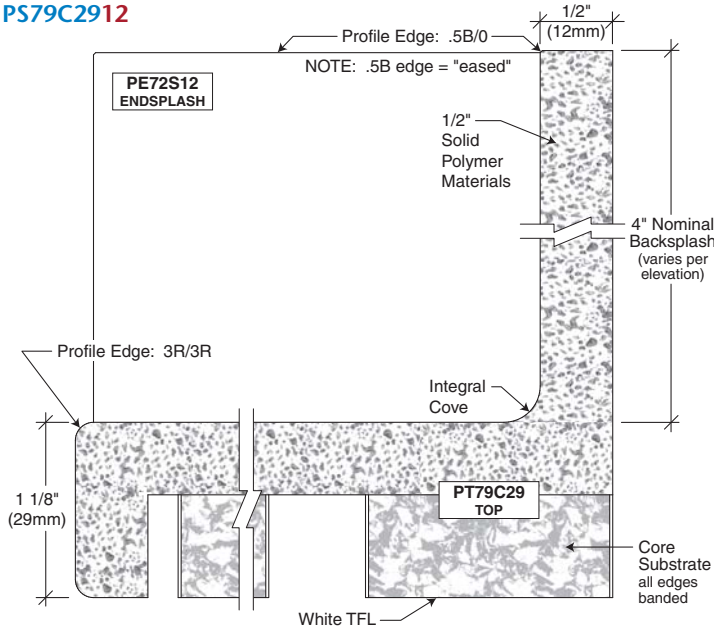

### PS79 SOLID SURFACE

- Solid surface (polymer) materials
- 3R/3R profile edge top
- Integral coved .5B/0 profile edge backsplash
- Applied .5B/0 profile edge endsplash

#### Series/Core Substrate Codes:

- PS79C** CARB particleboard
- PS79M** Moisture-resistant/NAF particleboard
- PS79F** Fire-rated particleboard
- PS79D** Medium Density Fiberboard (MDF)
- PS79G** Moisture-resistant/NAF MDF
- PS79H** Fire-rated MDF
- PS79P** Plywood

#### Endsplash Model/Core Code:

**PE72S** Solid

**PS79C, PS79M, PS79F, PS79D, PS79G, PS79H** and **PS79P** available countertop thicknesses:

29mm (1-1/8")

38mm (1-1/2")

*Drop edge available upon special request in 1/2" increments, from 2" to 6". Drop edge not available over casework.*

### PS80

Example:

**PS80C2912**

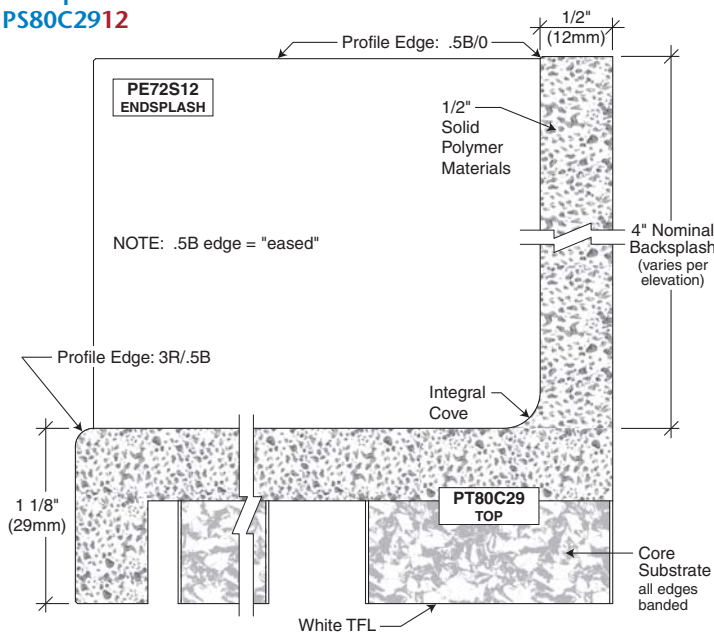

### PS80 SOLID SURFACE

- Solid surface (polymer) materials
- 3R/.5B profile edge top
- Integral coved .5B/0 profile edge backsplash
- Applied .5B/0 profile edge endsplash

#### Series/Core Substrate Codes:

- PS80C** CARB particleboard
- PS80M** Moisture-resistant/NAF particleboard
- PS80F** Fire-rated particleboard
- PS80D** Medium Density Fiberboard (MDF)
- PS80G** Moisture-resistant/NAF MDF
- PS80H** Fire-rated MDF
- PS80P** Plywood

#### Endsplash Model/Core Code:

**PE72S** Solid

**PS80C, PS80M, PS80F, PS80D, PS80G, PS80H** and **PS80P** available countertop thicknesses:

29mm (1-1/8")

38mm (1-1/2")

*Drop edge available upon special request in 1/2" increments, from 2" to 6". Drop edge not available over casework.*

# COUNTERTOPS

## Solid Surface Series

**PT = Solid Surface Top**  
**PE = Solid Surface Endsplash**



### PS81

Example:  
**PS81C2912**

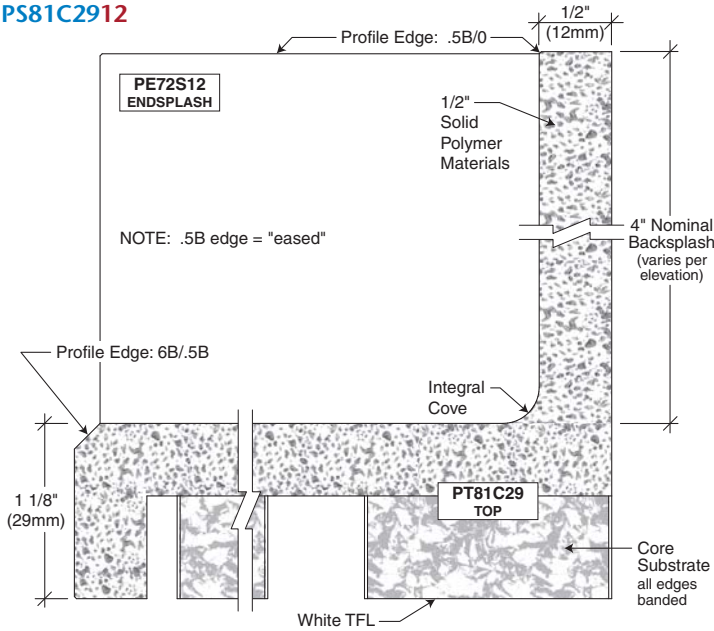

### PS81 SOLID SURFACE

- Solid surface (polymer) materials
- 6B/.5B profile edge top
- Integral cove .5B/0 profile edge backsplash
- Applied .5B/0 profile edge endsplash

#### Series/Core Substrate Codes:

- PS81C** CARB particleboard
- PS81M** Moisture-resistant/NAF particleboard
- PS81F** Fire-rated particleboard
- PS81D** Medium Density Fiberboard (MDF)
- PS81G** Moisture-resistant/NAF MDF
- PS81H** Fire-rated MDF
- PS81P** Plywood

#### Endsplash Model/Core Code:

**PE72S** Solid

**PS81C, PS81M, PS81F, PS81D, PS81G, PS81H** and **PS81P** available countertop thicknesses:  
 29mm (1-1/8")  
 38mm (1-1/2")

*Drop edge available upon special request in 1/2" increments, from 2" to 6". Drop edge not available over casework.*

### PS82

Example:  
**PS82C2912**

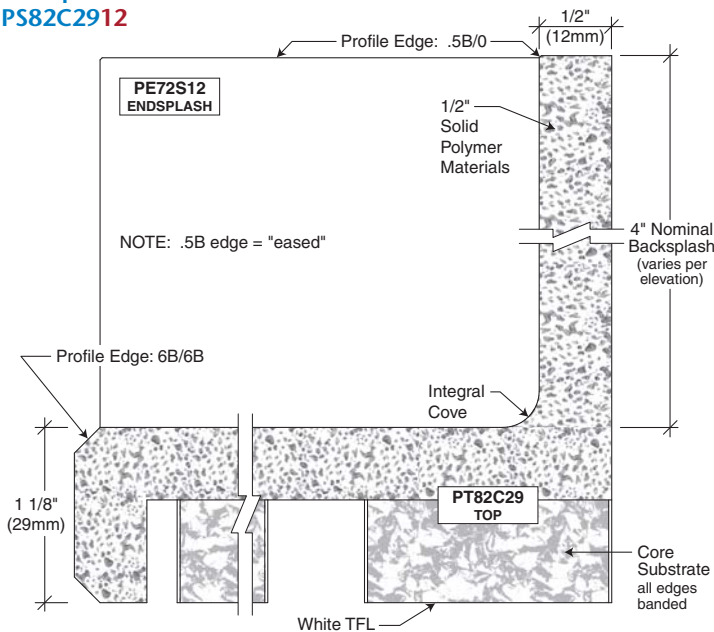

### PS82 SOLID SURFACE

- Solid surface (polymer) materials
- 6B/6B profile edge top
- Integral cove .5B/0 profile edge backsplash
- Applied .5B/0 profile edge endsplash

#### Series/Core Substrate Codes:

- PS82C** CARB particleboard
- PS82M** Moisture-resistant/NAF particleboard
- PS82F** Fire-rated particleboard
- PS82D** Medium Density Fiberboard (MDF)
- PS82G** Moisture-resistant/NAF MDF
- PS82H** Fire-rated MDF
- PS82P** Plywood

#### Endsplash Model/Core Code:

**PE72S** Solid

**PS82C, PS82M, PS82F, PS82D, PS82G, PS82H** and **PS82P** available countertop thicknesses:  
 29mm (1-1/8")  
 38mm (1-1/2")

*Drop edge available upon special request in 1/2" increments, from 2" to 6". Drop edge not available over casework.*



**PT = Solid Surface Top**  
**PE = Solid Surface Endsplash**

### PS83

Example:  
**PS83C2912**

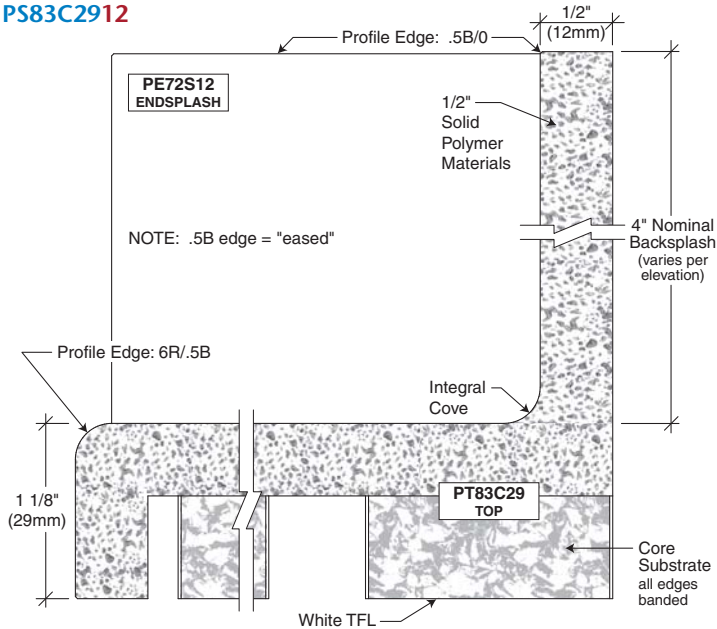

### PS83 SOLID SURFACE

- Solid surface (polymer) materials
- 6R/.5B profile edge top
- Integral coved .5B/0 profile edge backsplash
- Applied .5B/0 profile edge endsplash

#### Series/Core Substrate Codes:

- PS83C** CARB particleboard  
**PS83M** Moisture-resistant/NAF particleboard  
**PS83F** Fire-rated particleboard  
**PS83D** Medium Density Fiberboard (MDF)  
**PS83G** Moisture-resistant/NAF MDF  
**PS83H** Fire-rated MDF  
**PS83P** Plywood

#### Endsplash Model/Core Code:

**PE72S** Solid

**PS83C, PS83M, PS83F, PS83D, PS83G, PS83H** and **PS83P** available countertop thicknesses:  
 29mm (1-1/8")  
 38mm (1-1/2")

*Drop edge available upon special request in 1/2" increments, from 2" to 6". Drop edge not available over casework.*

### PS84

Example:  
**PS84C2912**

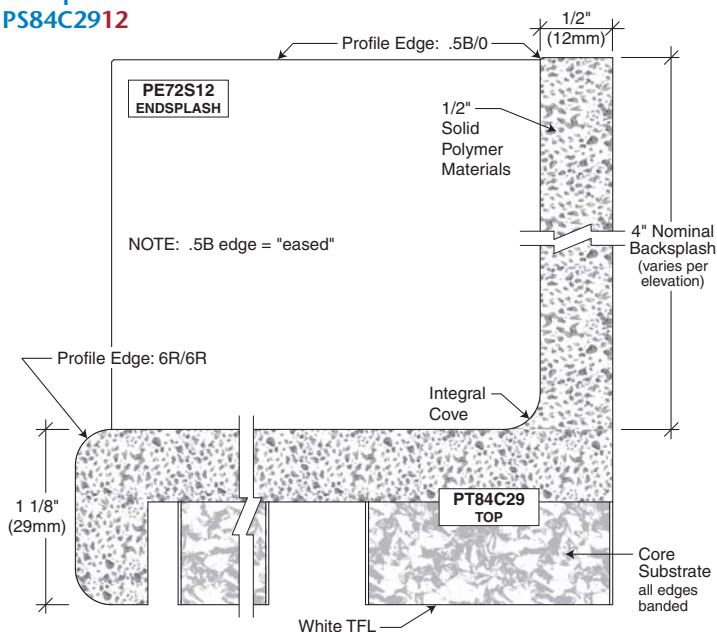

### PS84 SOLID SURFACE

- Solid surface (polymer) materials
- 6R/6R profile edge top
- Integral coved .5B/0 profile edge backsplash
- Applied .5B/0 profile edge endsplash

#### Series/Core Substrate Codes:

- PS84C** CARB particleboard  
**PS84M** Moisture-resistant/NAF particleboard  
**PS84F** Fire-rated particleboard  
**PS84D** Medium Density Fiberboard (MDF)  
**PS84G** Moisture-resistant/NAF MDF  
**PS84H** Fire-rated MDF  
**PS84P** Plywood

#### Endsplash Model/Core Code:

**PE72S** Solid

**PS84C, PS84M, PS84F, PS84D, PS84G, PS84H** and **PS84P** available countertop thicknesses:  
 29mm (1-1/8")  
 38mm (1-1/2")

*Drop edge available upon special request in 1/2" increments, from 2" to 6". Drop edge not available over casework.*

# COUNTERTOPS

## Solid Surface Series

PT = Solid Surface Top  
PE = Solid Surface Endsplash



### PS85

Example:  
PS85C2912

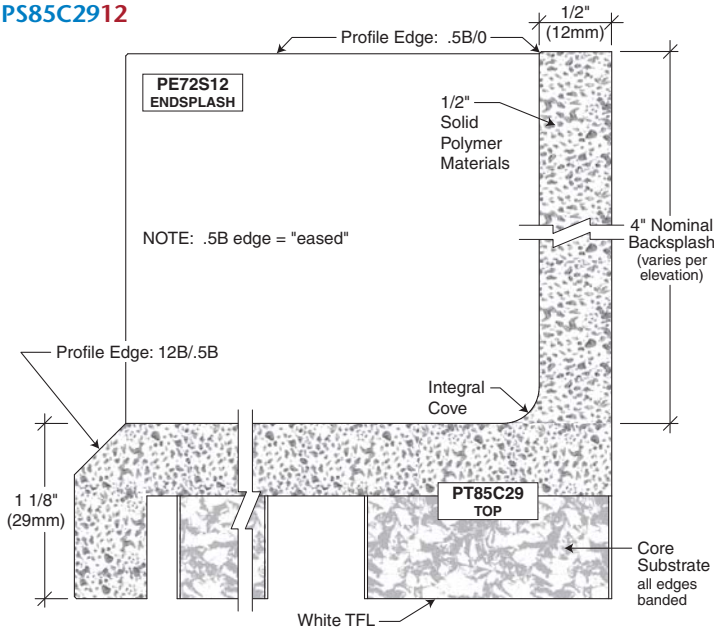

### PS85 SOLID SURFACE

- Solid surface (polymer) materials
- 12B/.5B profile edge top
- Integral coved .5B/0 profile edge backsplash
- Applied .5B/0 profile edge endsplash

#### Series/Core Substrate Codes:

- PS85C** CARB particleboard
- PS85M** Moisture-resistant/NAF particleboard
- PS85F** Fire-rated particleboard
- PS85D** Medium Density Fiberboard (MDF)
- PS85G** Moisture-resistant/NAF MDF
- PS85H** Fire-rated MDF
- PS85P** Plywood

#### Endsplash Model/Core Code:

**PE72S** Solid

**PS85C, PS85M, PS85F, PS85D, PS85G, PS85H** and **PS85P** available countertop thicknesses:  
29mm (1-1/8")  
38mm (1-1/2")

*Drop edge available upon special request in 1/2" increments, from 2" to 6". Drop edge not available over casework.*

### PS86

Example:  
PS86C2912

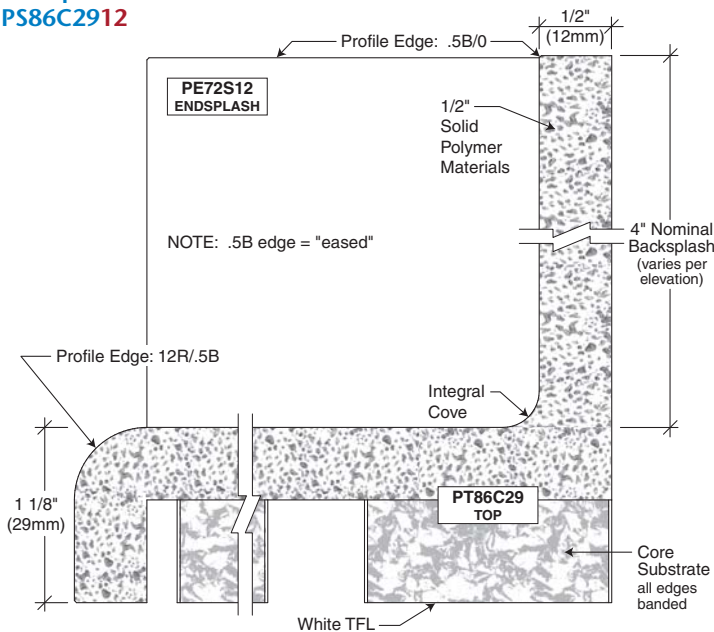

### PS86 SOLID SURFACE

- Solid surface (polymer) materials
- 12R/.5B profile edge top
- Integral coved .5B/0 profile edge backsplash
- Applied .5B/0 profile edge endsplash

#### Series/Core Substrate Codes:

- PS86C** CARB particleboard
- PS86M** Moisture-resistant/NAF particleboard
- PS86F** Fire-rated particleboard
- PS86D** Medium Density Fiberboard (MDF)
- PS86G** Moisture-resistant/NAF MDF
- PS86H** Fire-rated MDF
- PS86P** Plywood

#### Endsplash Model/Core Code:

**PE72S** Solid

**PS86C, PS86M, PS86F, PS86D, PS86G, PS86H** and **PS86P** available countertop thicknesses:  
29mm (1-1/8")  
38mm (1-1/2")

*Drop edge available upon special request in 1/2" increments, from 2" to 6". Drop edge not available over casework.*

**PT = Solid Surface Top**  
**PE = Solid Surface Endsplash**

### PS87

Example:  
**PS87C2912**

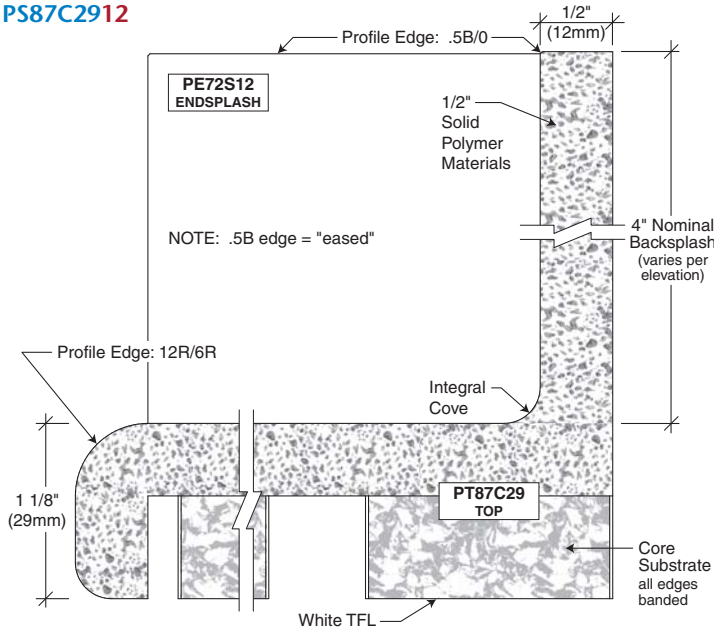

### PS87 SOLID SURFACE

- Solid surface (polymer) materials
- 12R/6R profile edge top
- Integral coved .5B/0 profile edge backsplash
- Applied .5B/0 profile edge endsplash

#### Series/Core Substrate Codes:

- PS87C** CARB particleboard  
**PS87M** Moisture-resistant/NAF particleboard  
**PS87F** Fire-rated particleboard  
**PS87D** Medium Density Fiberboard (MDF)  
**PS87G** Moisture-resistant/NAF MDF  
**PS87H** Fire-rated MDF  
**PS87P** Plywood

#### Endsplash Model/Core Code:

**PE72S** Solid

**PS87C, PS87M, PS87F, PS87D, PS87G, PS87H** and **PS87P** available countertop thicknesses:  
 29mm (1-1/8")  
 38mm (1-1/2")

*Drop edge available upon special request in 1/2" increments, from 2" to 6". Drop edge not available over casework.*

### PS88

Example:  
**PS88C2912**

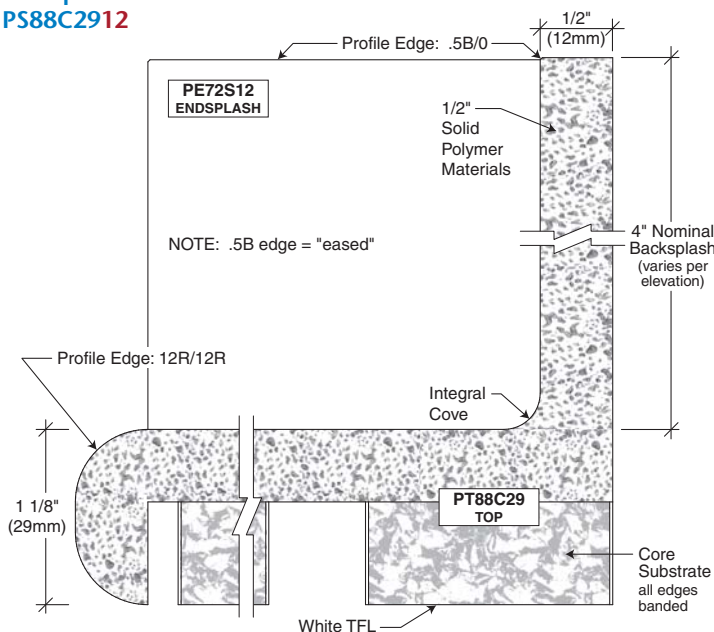

### PS88 SOLID SURFACE

- Solid surface (polymer) materials
- 12R/12R profile edge top
- Integral coved .5B/0 profile edge backsplash
- Applied .5B/0 profile edge endsplash

#### Series/Core Substrate Codes:

- PS88C** CARB particleboard  
**PS88M** Moisture-resistant/NAF particleboard  
**PS88F** Fire-rated particleboard  
**PS88D** Medium Density Fiberboard (MDF)  
**PS88G** Moisture-resistant/NAF MDF  
**PS88H** Fire-rated MDF  
**PS88P** Plywood

#### Endsplash Model/Core Code:

**PE72S** Solid

**PS88C, PS88M, PS88F, PS88D, PS88G, PS88H** and **PS88P** available countertop thicknesses:  
 29mm (1-1/8")  
 38mm (1-1/2")

*Drop edge available upon special request in 1/2" increments, from 2" to 6". Drop edge not available over casework.*



# COUNTERTOPS

## Solid Surface Series

PT = Solid Surface Top  
PE = Solid Surface Endsplash



### PS92

Example:  
PS92C2912

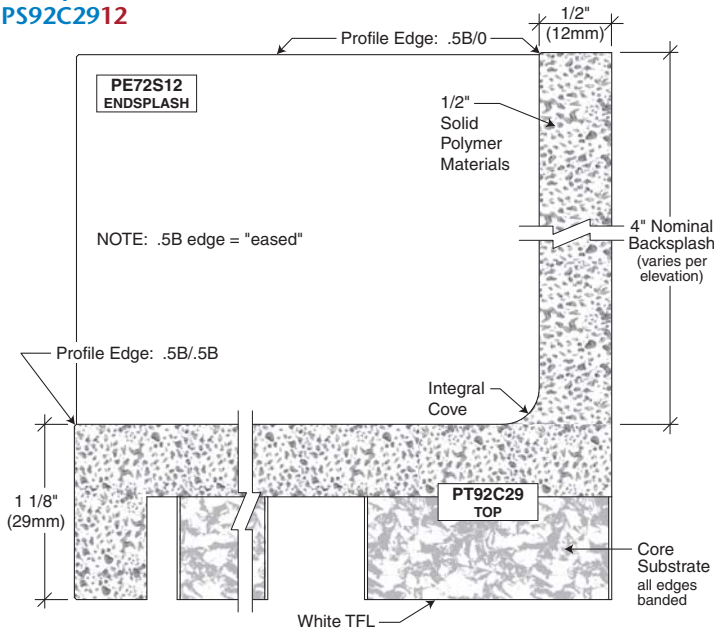

### PS92 SOLID SURFACE

- Solid surface (polymer) materials
- .5B/.5B profile edge top
- Integral cove .5B/0 profile edge backsplash
- Applied .5B/0 profile edge endsplash

### Series/Core Substrate Codes:

- PS92C** CARB particleboard
- PS92M** Moisture-resistant/NAF particleboard
- PS92F** Fire-rated particleboard
- PS92D** Medium Density Fiberboard (MDF)
- PS92G** Moisture-resistant/NAF MDF
- PS92H** Fire-rated MDF
- PS92P** Plywood

### Endsplash Model/Core Code:

- PE72S** Solid

**PS92C, PS92M, PS92F, PS92D, PS92G, PS92H** and **PS92P** available countertop thicknesses:

- 29mm (1-1/8")
- 38mm (1-1/2")

*Drop edge available upon special request in 1/2" increments, from 2" to 6". Drop edge not available over casework.*

ET = Epoxy Top  
EB = Epoxy Backsplash  
EE = Epoxy Endsplash

### ES00

Example:  
ES00AW1919

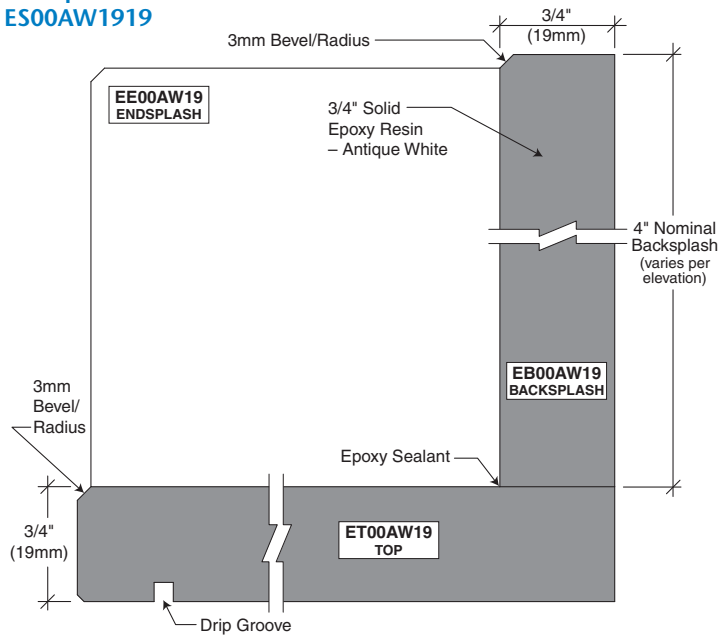

### ES00 EPOXY RESIN

- Solid epoxy resin
- 3mm bevel/radius edges with smooth edge finish
- Applied backsplash and endsplash
- Drip groove
- Butt joints and attachment with field applied epoxy sealant and adhesives
- Epoxy resin coordinated sinks where specified
- Factory fabricated cutouts and drillings

### Series/Color Codes:

**ES00AW** Antique White  
**ES00BL** Black  
**ES00DK** Dark Khaki  
**ES00GR** Grey  
**ES00PL** Platinum  
**ES00SA** Sandstone

**ES00** available countertop thicknesses:  
19mm (3/4")  
25mm (1")

### ES01

Example:  
ES01AW1919

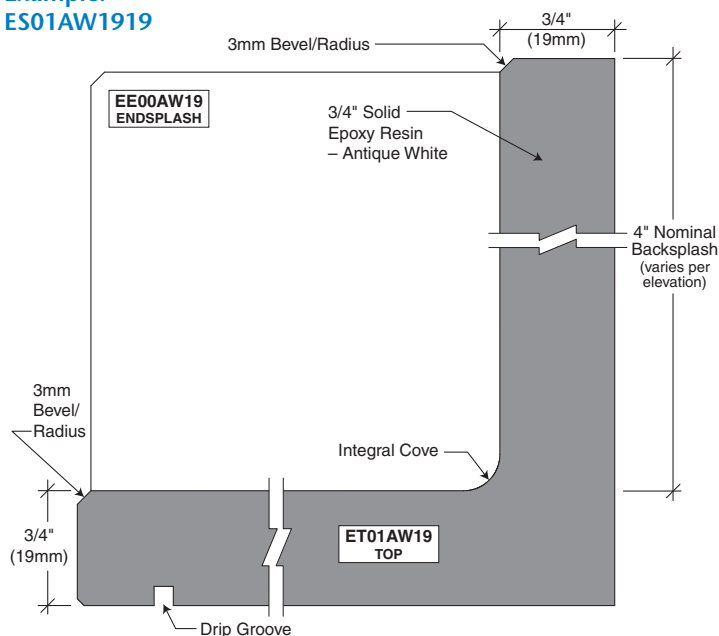

### ES01 EPOXY RESIN

- Solid epoxy resin
- 3mm bevel/radius edges with smooth edge finish
- Integral covered backsplash
- Applied endsplash
- Drip groove
- Butt joints and attachment with field applied epoxy sealant and adhesives
- Epoxy resin coordinated sinks where specified
- Factory fabricated cutouts and drillings

### Series/Color Codes:

**ES01AW** Antique White  
**ES01BL** Black  
**ES01DK** Dark Khaki  
**ES01GR** Grey  
**ES01PL** Platinum  
**ES01SA** Sandstone

**ES01** available countertop thicknesses:  
19mm (3/4")  
25mm (1")

# COUNTERTOPS

## Epoxy Resin Series

ET = Epoxy Top  
 EB = Epoxy Backsplash  
 EE = Epoxy Endsplash



### ES02

Example:  
 ES02AW2519

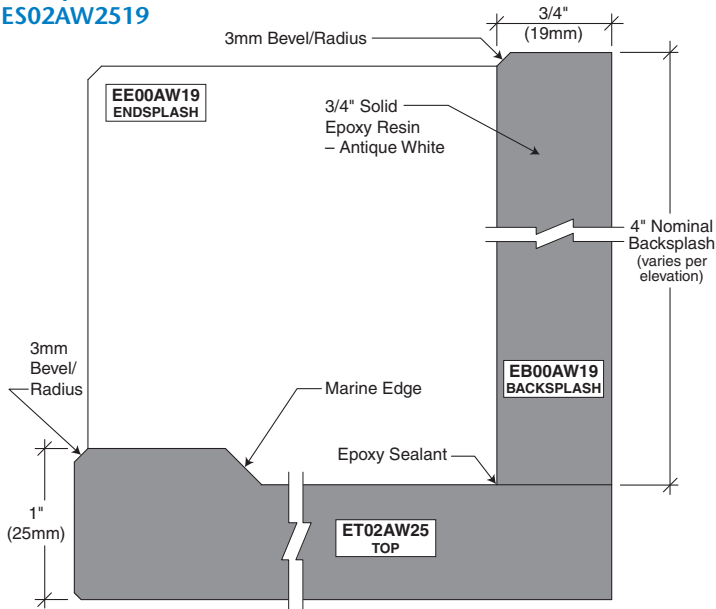

### ES02 EPOXY RESIN

- Solid epoxy resin
- Lipped marine edge
- 3mm bevel/radius edges with smooth edge finish
- Applied backsplash and endsplash
- ~~Drip groove~~
- Butt joints and attachment with field applied epoxy sealant and adhesives
- Epoxy resin coordinated sinks where specified
- Factory fabricated cutouts and drillings

### Series/Color Codes:

- ES02AW Antique White
- ES02BL Black
- ES02DK Dark Khaki
- ES02GR Grey
- ES02PL Platinum
- ES02SA Sandstone

ES02 available countertop thickness:  
 25mm (1")

### ES03

Example:  
 ES03AW2519

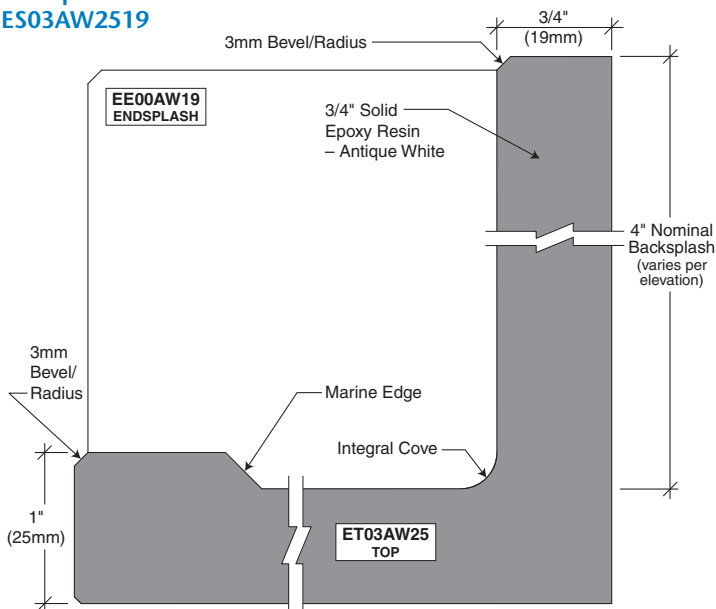

### ES03 EPOXY RESIN

- Solid epoxy resin
- Lipped marine edge
- 3mm bevel/radius edges with smooth edge finish
- Integral covered backsplash
- Applied endsplash
- ~~Drip groove~~
- Butt joints and attachment with field applied epoxy sealant and adhesives
- Epoxy resin coordinated sinks where specified
- Factory fabricated cutouts and drillings

### Series/Color Codes:

- ES03AW Antique White
- ES03BL Black
- ES03DK Dark Khaki
- ES03GR Grey
- ES03PL Platinum
- ES03SA Sandstone

ES03 available countertop thickness:  
 25mm (1")

WT = Hardwood Top  
WB = Hardwood Backsplash  
WE = Hardwood Endsplash

### WD00

Example:  
WD00S3819

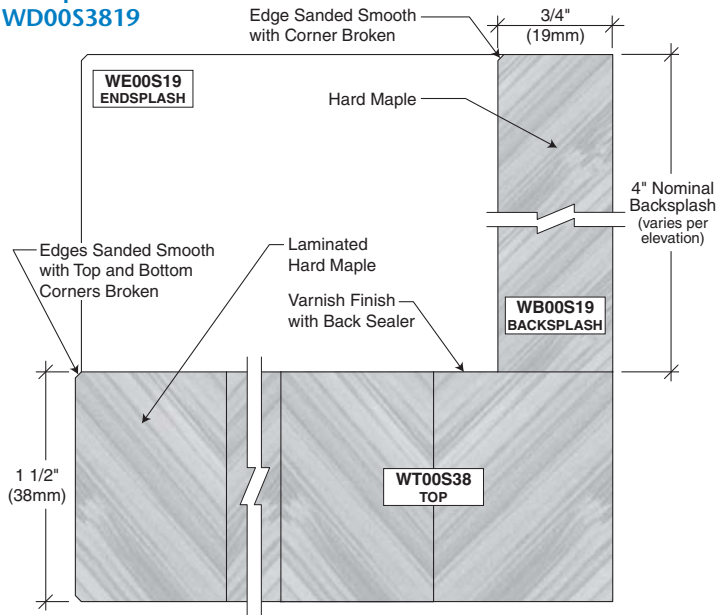

### WD00 HARDWOOD

- Fabricated from laminated kiln dried hard maple lumber
- Industrial grade with butt joints and edge grain fabrication (butcher block) design
- Edges sanded smooth with top and bottom corners broken
- Faces and edges sealed with varnish finish

### Series/Core Code:

**WD00S** Solid hard maple

**WD00S** available countertop thicknesses:

38mm (1-1/2")

44mm (1-3/4")

**Note:** Laminated maple lumber tops are susceptible to changes due to moisture, heat and cold conditions. Warpage and edge splitting may occur under unusual field conditions. Wood tops should only be delivered and installed after project HVAC systems are working and balanced for normal interior conditions. Never store or use in high or low humidity with cyclical conditions.

# COUNTERTOPS

## Workbench Series

**BT = Workbench Top**  
**BB = Workbench Backsplash**  
**BE = Workbench Endsplash**



### BW00

Example:  
BW00C3820

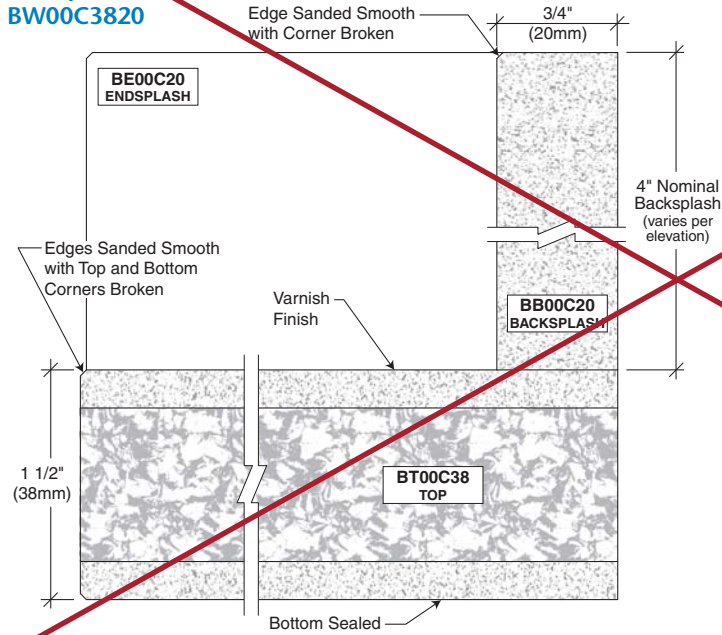

### BW00 WORKBENCH

- Countertop: laminated 3-piece construction with CARB particleboard core and 1/4" MDF top and bottom faces
- Applied backsplash and endsplash: MDF
- Edges sanded smooth with top and bottom corners broken
- Top face and edges with varnish finish
- Bottom face sealed

#### Series/Core Code:

**BW00C** CARB particleboard

**BW00C** available countertop thickness:  
38mm (1-1/2")

ST = Stainless Steel Top

### SS00

Example:  
SS00P2725

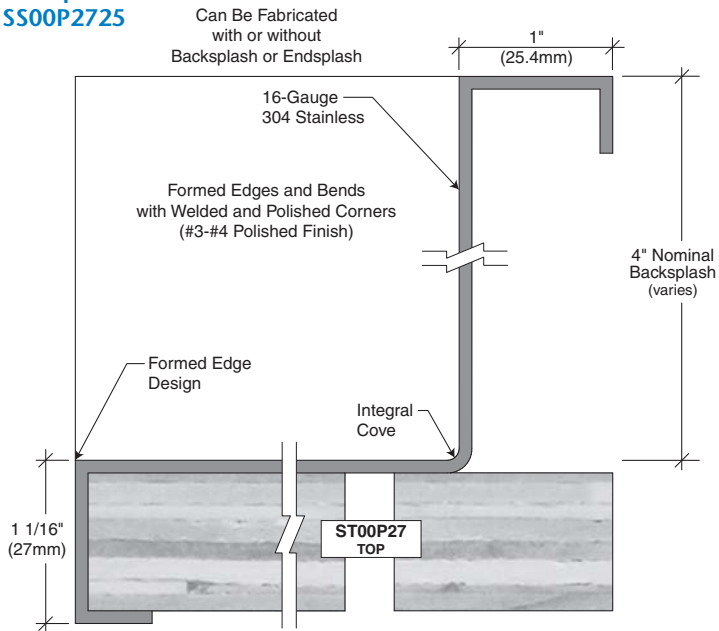

### SS00 STAINLESS STEEL

- Formed edge design with integral cove
- Fabricated from 16-gauge 304 stainless steel
- Formed edges and bends with welded and polished corners
- Can be fabricated with or without backsplash or endsplash

### Series/Core Codes:

**SS00P** Plywood  
**SS00R** Stainless Steel Rail

**SS00P** and **SS00R** available countertop thickness:  
27mm (1-1/16")

Example:  
SS00R2725

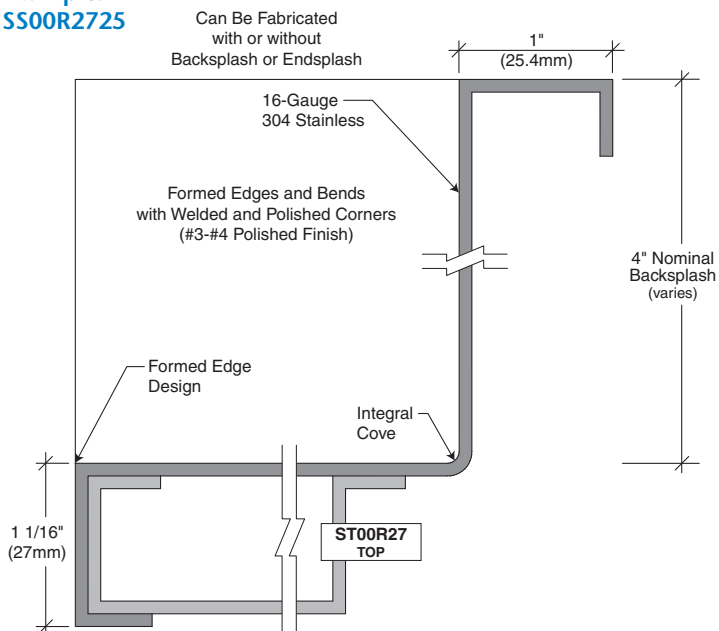

# COUNTERTOPS

## Stainless Steel Series

ST = Stainless Steel Top



### SS01

Example:  
SS01P3225

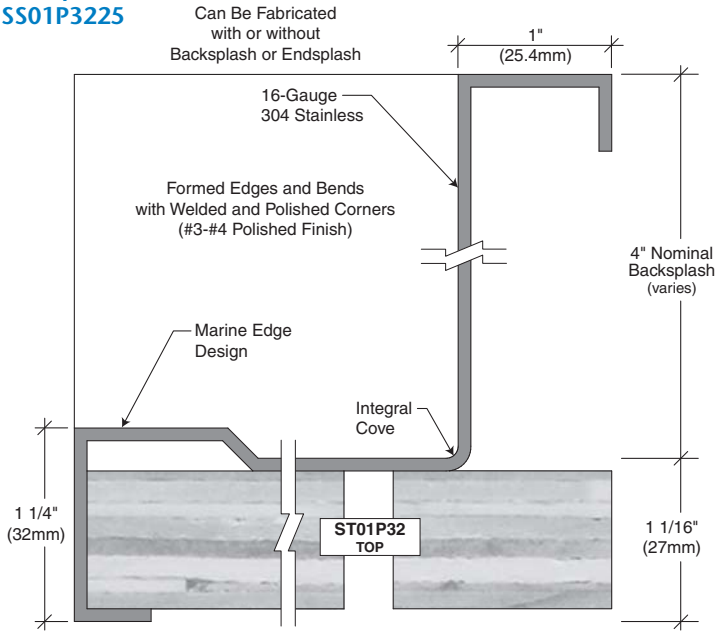

### SS01 STAINLESS STEEL

- Marine edge design with integral cove
- Fabricated from 16-gauge 304 stainless steel
- Formed edges and bends with welded and polished corners
- Can be fabricated with or without backsplash or endsplash

### Series/Core Codes:

- SS01P Plywood
- SS01R Stainless Steel Rail

SS01P and SS01R available countertop thickness:  
32mm (1-1/4")

Example:  
SS01R3225

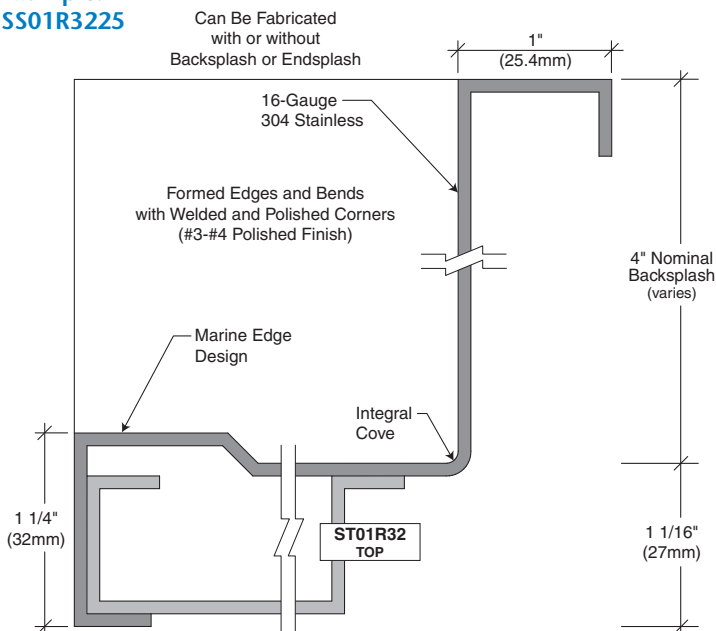



AT = Phenolic Top  
AB = Phenolic Backsplash  
AE = Phenolic Endsplash

### AP00

Example:  
AP00S1919

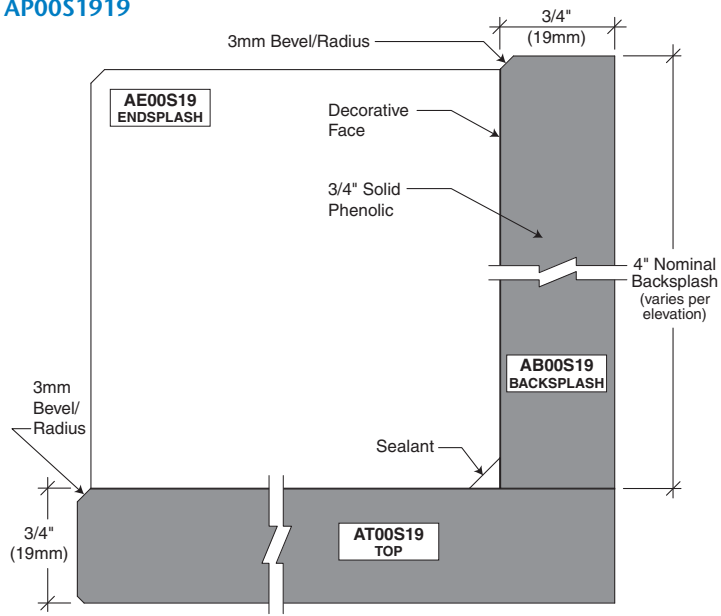

### AP00 PHENOLIC

- Solid phenolic core with decorative face pattern
- 3mm bevel/radius edges, polished for consistent edge look
- Applied backsplash and endsplash

#### Series/Core Code:

AP00S Solid

AP00S available countertop thickness:

19mm (3/4")

25mm (1")

### AP01

Example:  
AP01S1919

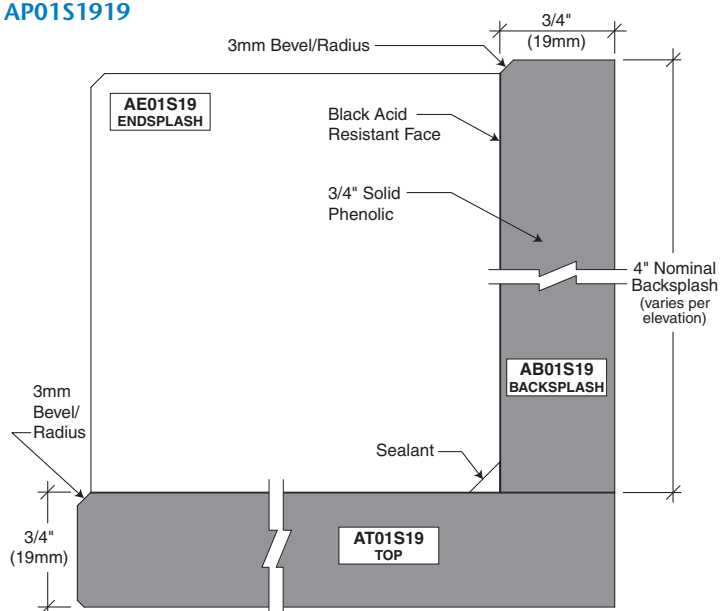

### AP01 PHENOLIC

- Solid phenolic core with black acid resistant face
- 3mm bevel/radius edges, polished for consistent edge look
- Applied backsplash and endsplash

#### Series/Core Code:

AP01S Solid

AP01S available countertop thickness:

19mm (3/4")

25mm (1")

# COUNTERTOPS

## Phenolic Series

AT = Phenolic Top  
 AB = Phenolic Backsplash  
 AE = Phenolic Endsplash



### AP02

Example:  
 AP02S1919

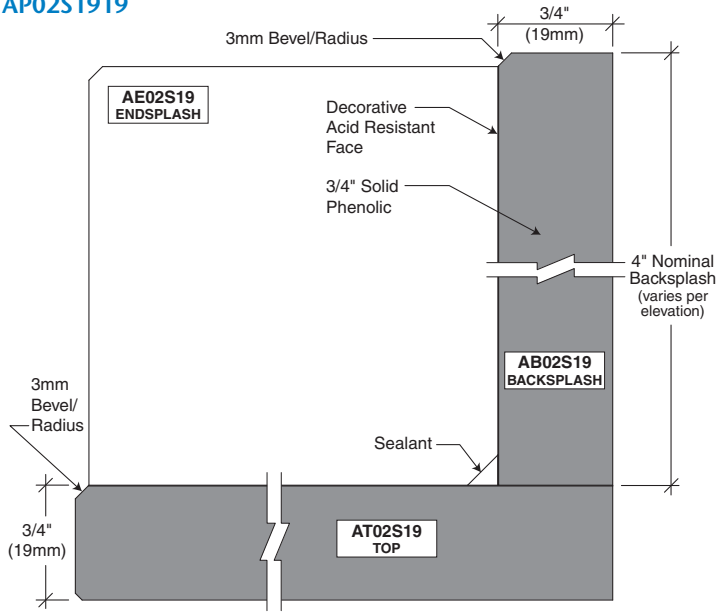

### AP02 PHENOLIC

- Solid phenolic core with decorative acid resistant face
- 3mm bevel/radius edges, polished for consistent edge look
- Applied backsplash and endsplash

#### Series/Core Code:

AP02S Solid

AP02S available countertop thickness:  
 19mm (3/4")  
 25mm (1")

### AP03

Example:  
 AP03S1919

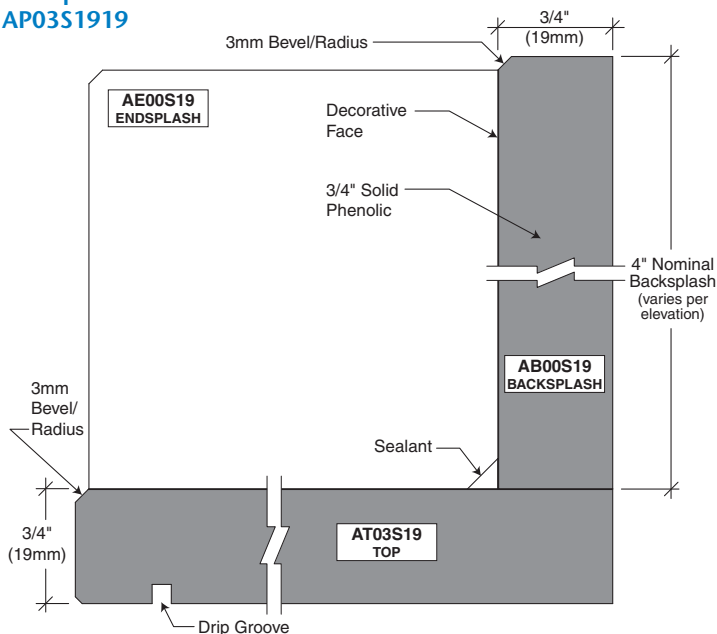

### AP03 PHENOLIC

- Solid phenolic core with decorative face pattern
- 3mm bevel/radius edges, polished for consistent edge look
- Applied backsplash and endsplash
- Drip groove

#### Series/Core Code:

AP03S Solid

AP03S available countertop thickness:  
 19mm (3/4")  
 25mm (1")

AT = Phenolic Top  
AB = Phenolic Backsplash  
AE = Phenolic Endsplash

### AP04

Example:  
AP04S1919

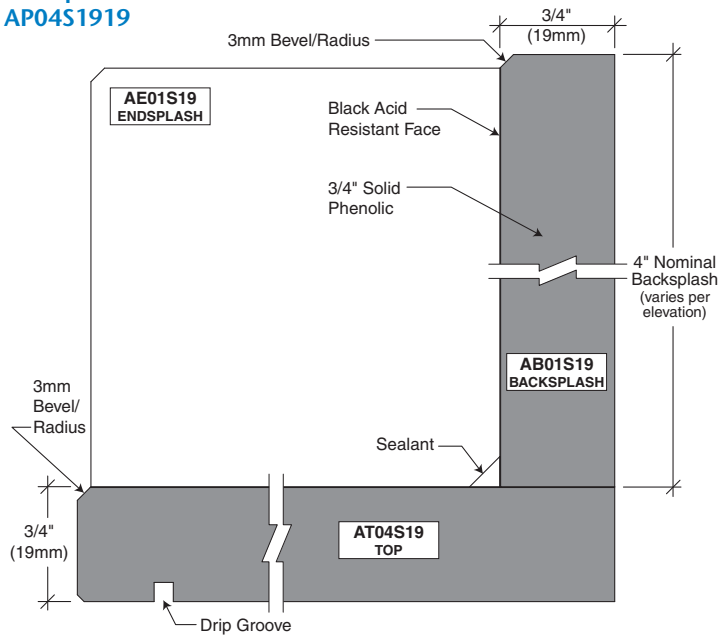

### AP04 PHENOLIC

- Solid phenolic core with black acid resistant face
- 3mm bevel/radius edges, polished for consistent edge look
- Applied backsplash and endsplash
- Drip groove

#### Series/Core Code:

**AP04S** Solid

**AP04S** available countertop thickness:  
19mm (3/4")  
25mm (1")

### AP05

Example:  
AP05S1919

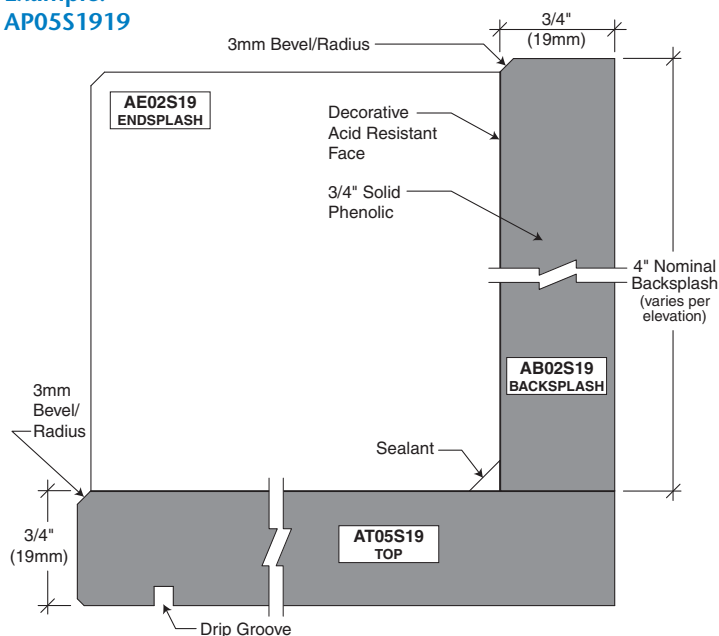

### AP05 PHENOLIC

- Solid phenolic core with decorative acid resistant face
- 3mm bevel/radius edges, polished for consistent edge look
- Applied backsplash and endsplash
- Drip groove

#### Series/Core Code:

**AP05S** Solid

**AP05S** available countertop thickness:  
19mm (3/4")  
25mm (1")

# COUNTERTOPS

## Granite Series

GT = Granite Top  
GB = Granite Backsplash  
GE = Granite Endsplash



### GS00

Example:  
GS00S2020

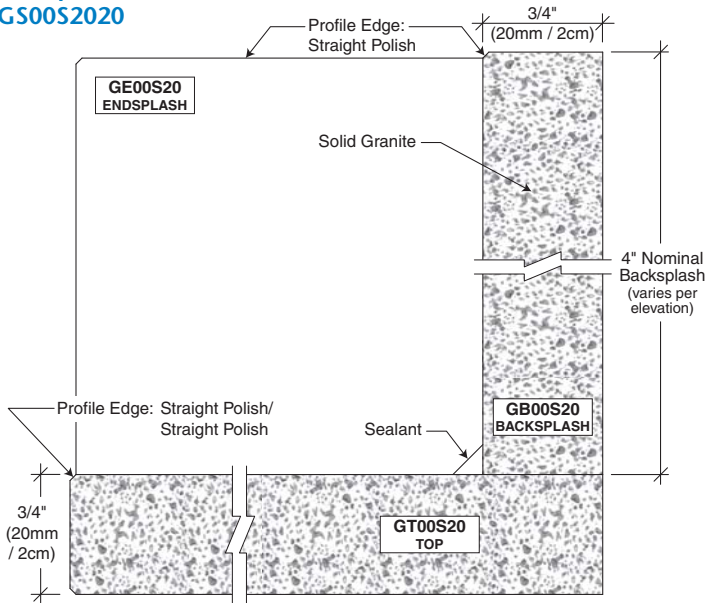

### GS00 GRANITE

- Solid granite
- Straight Polish/Straight Polish profile edge top
- Applied Straight Polish profile edge backsplash and endsplash

#### Series/Core Code:

GS00S Solid

GS00S available countertop thicknesses:

- 20mm / 2cm (3/4")
- 30mm / 3cm (1-3/16")

### GS01

Example:  
GS01S2020

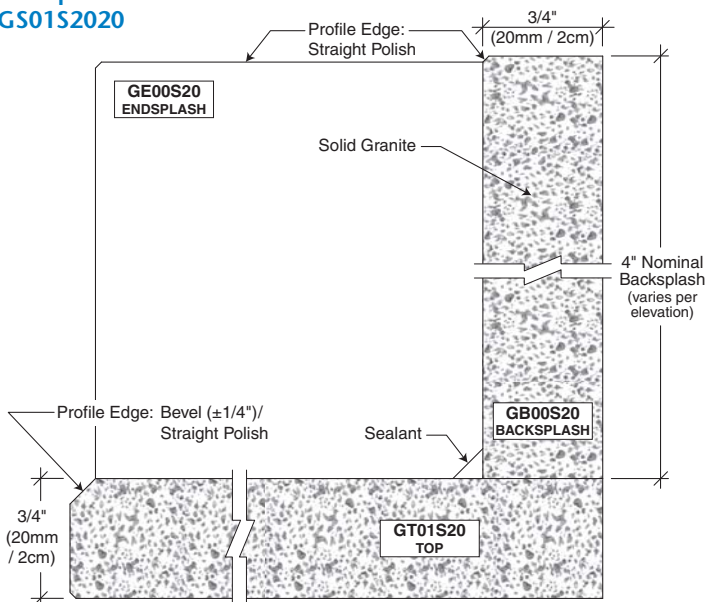

### GS01 GRANITE

- Solid granite
- Bevel ( $\pm 1/4$ ")/Straight Polish profile edge top
- Applied Straight Polish profile edge backsplash and endsplash

#### Series/Core Code:

GS01S Solid

GS01S available countertop thicknesses:

- 20mm / 2cm (3/4")
- 30mm / 3cm (1-3/16")

GT = Granite Top  
GB = Granite Backsplash  
GE = Granite Endsplash

### GS02

Example:  
GS02S2020

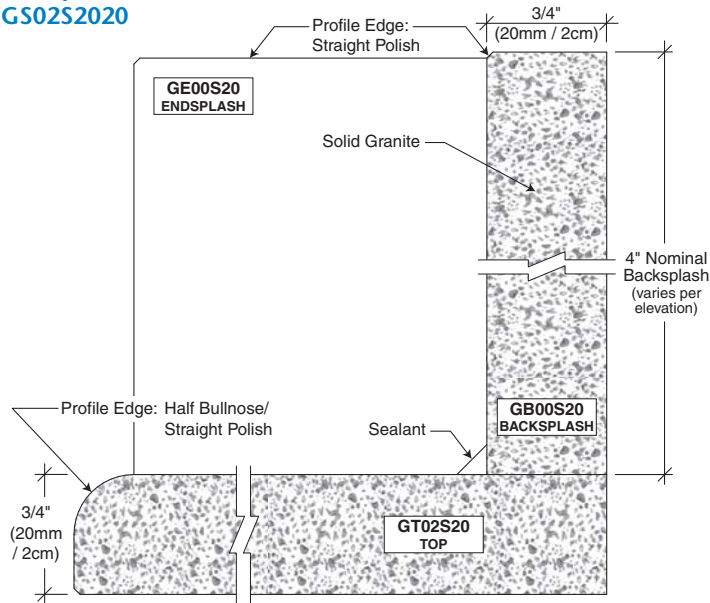

### GS02 GRANITE

- Solid granite
- Half Bullnose/Straight Polish profile edge top
- Applied Straight Polish profile edge backsplash and endsplash

### Series/Core Code:

**GS02S** Solid

**GS02S** available countertop thicknesses:

20mm / **2cm** (3/4")

30mm / **3cm** (1-3/16")

# COUNTERTOPS

## Marble Series

MT = Marble Top  
 MB = Marble Backsplash  
 ME = Marble Endsplash



### MS00

Example:  
 MS00S2020

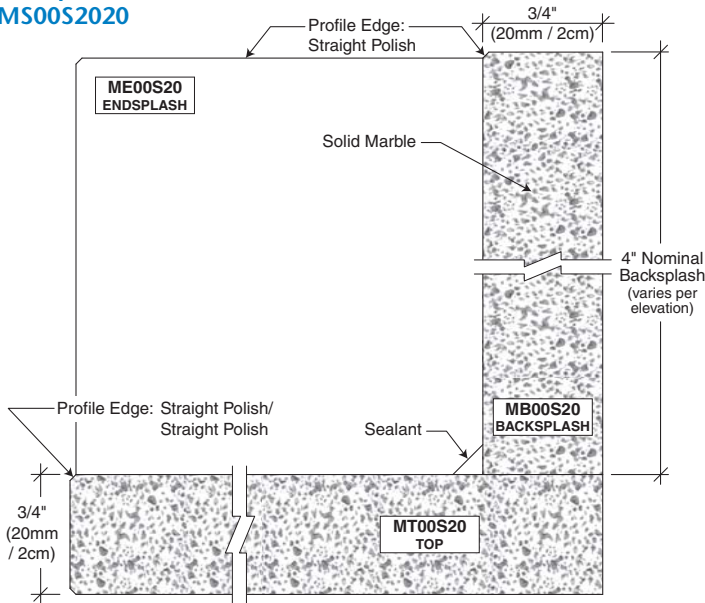

### MS00 MARBLE

- Solid marble
- Straight Polish/Straight Polish profile edge top
- Applied Straight Polish profile edge backsplash and endsplash

#### Series/Core Code:

**MS00S** Solid

**MS00S** available countertop thicknesses:

- 20mm / 2cm (3/4")
- 30mm / 3cm (1-3/16")

### MS01

Example:  
 MS01S2020

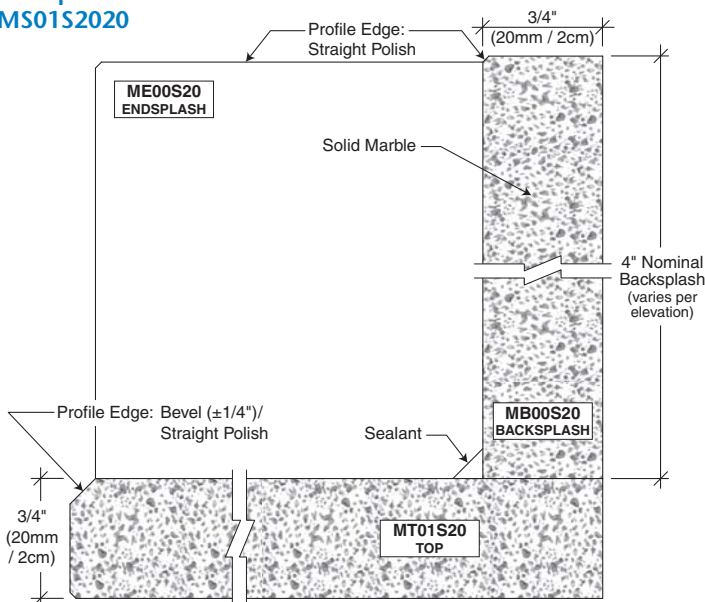

### MS01 MARBLE

- Solid marble
- Bevel (± 1/4")/Straight Polish profile edge top
- Applied Straight Polish profile edge backsplash and endsplash

#### Series/Core Code:

**MS01S** Solid

**MS01S** available countertop thicknesses:

- 20mm / 2cm (3/4")
- 30mm / 3cm (1-3/16")



MT = Marble Top  
MB = Marble Backsplash  
ME = Marble Endsplash

### MS02

Example:  
MS02S2020

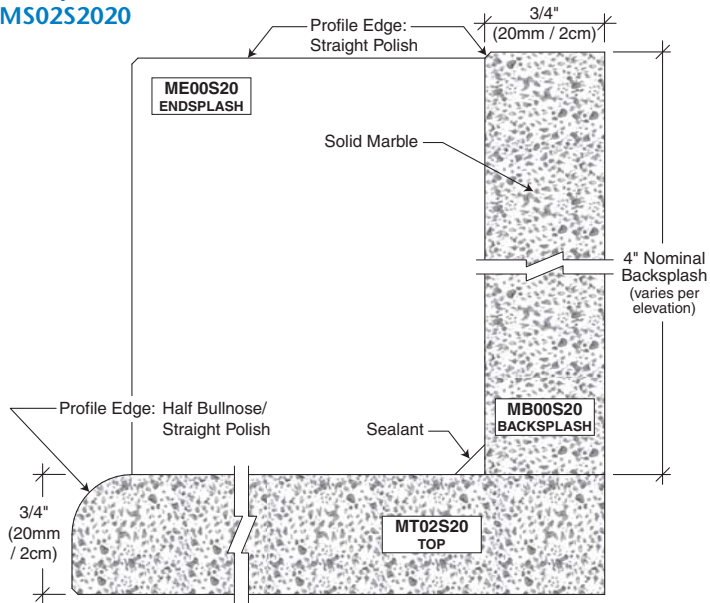

### MS02 MARBLE

- Solid marble
- Half Bullnose/Straight Polish profile edge top
- Applied Straight Polish profile edge backsplash and endsplash

### Series/Core Code:

**MS02S** Solid

**MS02S** available countertop thicknesses:

- 20mm / **2cm** (3/4")
- 30mm / **3cm** (1-3/16")

# COUNTERTOPS

## Quartz Series

**QT = Quartz Top**  
**QB = Quartz Backsplash**  
**QE = Quartz Endsplash**



### QS00

**Example:**  
**QS00S2020**

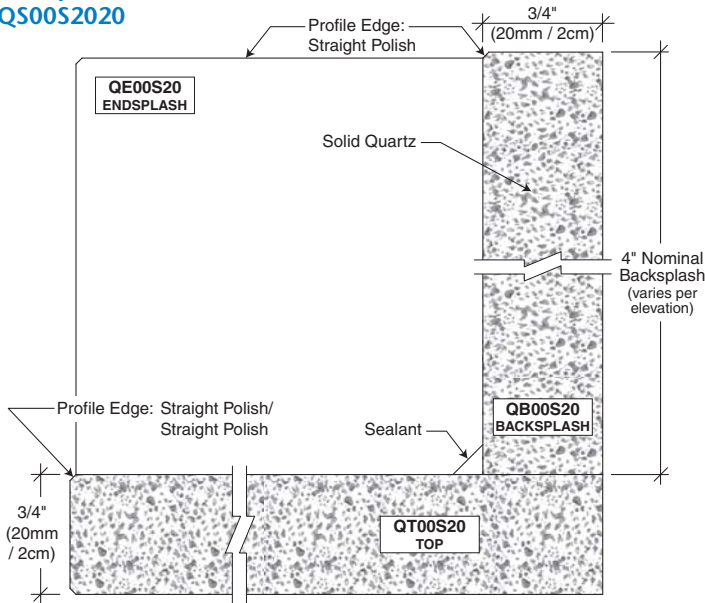

### QS00 QUARTZ

- Solid quartz
- Straight Polish/Straight Polish profile edge top
- Applied Straight Polish profile edge backsplash and endsplash

#### Series/Core Code:

**QS00S** Solid

**QS00S** available countertop thicknesses:

- 20mm / 2cm (3/4")
- 30mm / 3cm (1-3/16")

### QS01

**Example:**  
**QS01S2020**

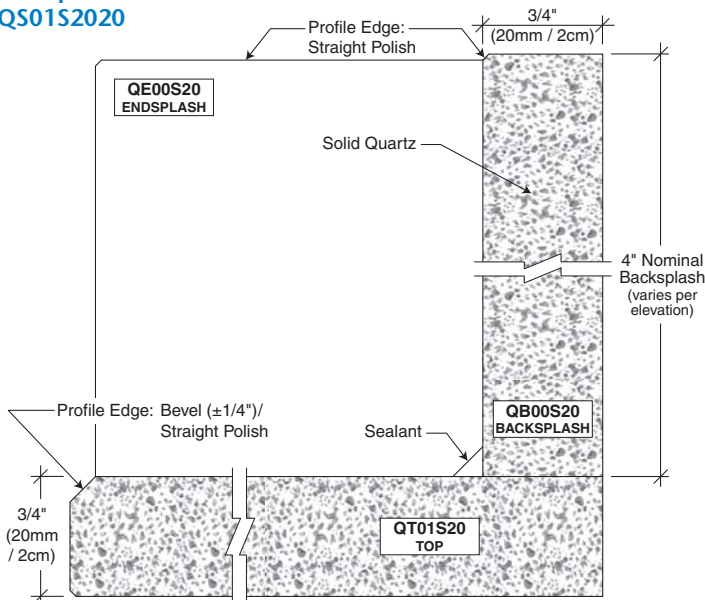

### QS01 QUARTZ

- Solid quartz
- Bevel (± 1/4")/Straight Polish profile edge top
- Applied Straight Polish edge backsplash and endsplash

#### Series/Core Code:

**QS01S** Solid

**QS01S** available countertop thicknesses:

- 20mm / 2cm (3/4")
- 30mm / 3cm (1-3/16")

QT = Quartz Top  
QB = Quartz Backsplash  
QE = Quartz Endsplash

### QS02

Example:  
QS02S2020

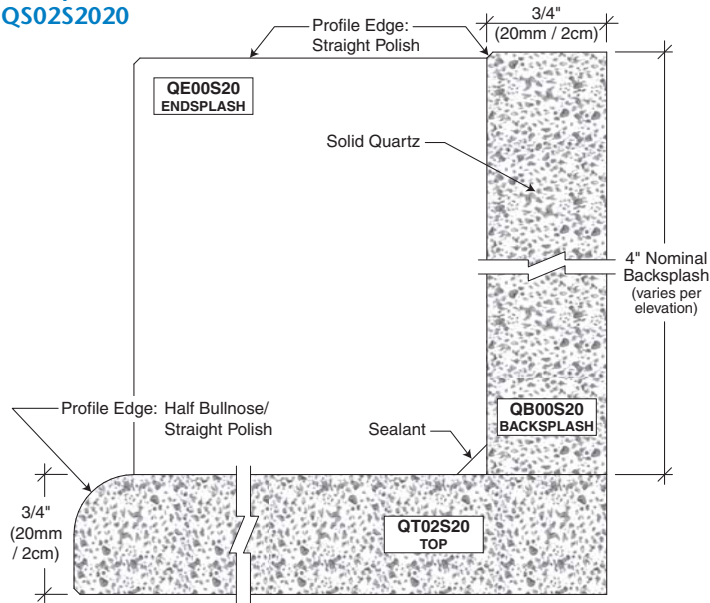

### QS02 QUARTZ

- Solid quartz
- Half Bullnose/Straight Polish profile edge top
- Applied Straight Polish profile edge backsplash and endsplash

### Series/Core Code:

**QS02S** Solid

**QS02S** available countertop thicknesses:

- 20mm / **2cm** (3/4")
- 30mm / **3cm** (1-3/16")

# COUNTERTOPS

## Laminate Series

LT = Laminate Top



### LS50

Example:  
LS50C27

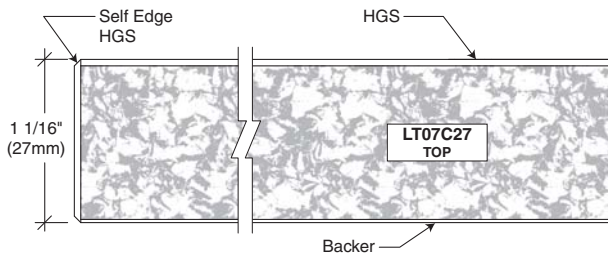

### LS50 LAMINATE WINDOWSILL

- Self edge

#### Series/Core Codes:

- LS50C** CARB particleboard
- LS50M** Moisture-resistant/NAF particleboard
- LS50F** Fire-rated particleboard
- LS50D** Medium Density Fiberboard (MDF)
- LS50G** Moisture-resistant/NAF MDF
- LS50H** Fire-rated MDF
- LS50P** Plywood

#### LS50C, LS50M, LS50F, LS50D, LS50G and LS50H

available windowsill thicknesses:

- 21mm (13/16")
- 27mm (1-1/16")
- 30mm (1-3/16")
- 40mm (1-9/16") (n/a for LS50H fire-rated MDF)

**LS50P** available windowsill thicknesses:

- 20mm (3/4")
- 27mm (1-1/16")
- 40mm (1-9/16")

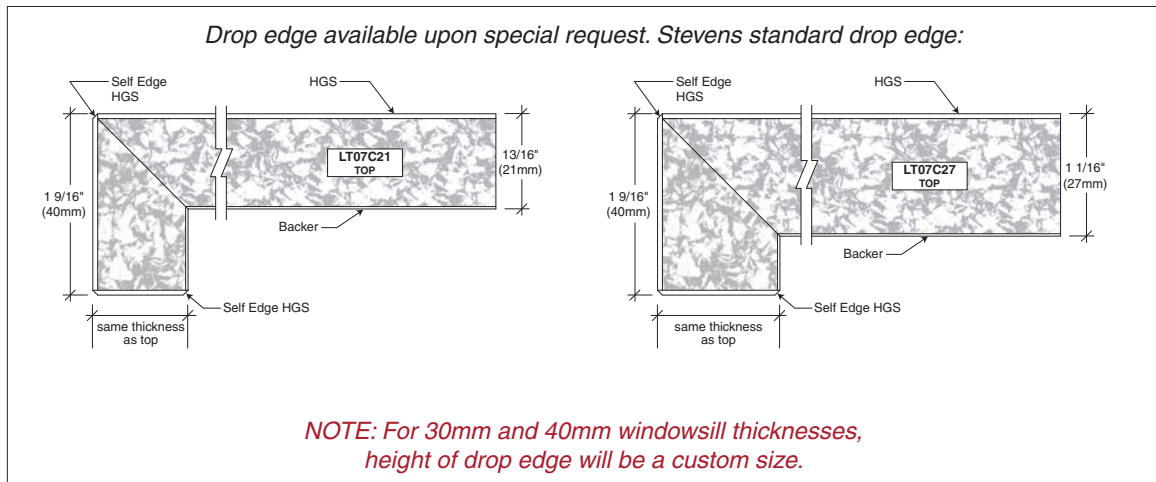

LT = Laminate Top

### LS51

Example:  
LS51C27

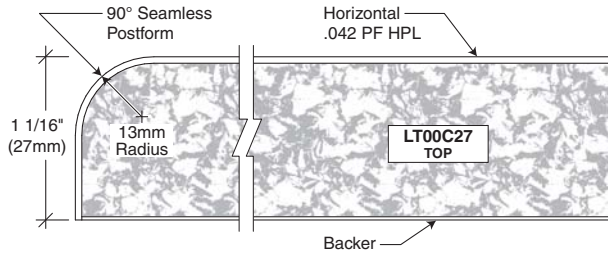

### LS51 LAMINATE WINDOWSILL

- 90° postform edge

#### Series/Core Codes:

- LS51C** CARB particleboard
- LS51M** Moisture-resistant/NAF particleboard
- LS51F** Fire-rated particleboard
- LS51D** Medium Density Fiberboard (MDF)
- LS51G** Moisture-resistant/NAF MDF
- LS51H** Fire-rated MDF

**LS51C, LS51M, LS51F, LS51D, LS51G and LS51H** available windowsill thicknesses:

- 21mm (13/16")
- 27mm (1-1/16")
- 30mm (1-3/16")
- 40mm (1-9/16") (n/a for LS51H fire-rated MDF)

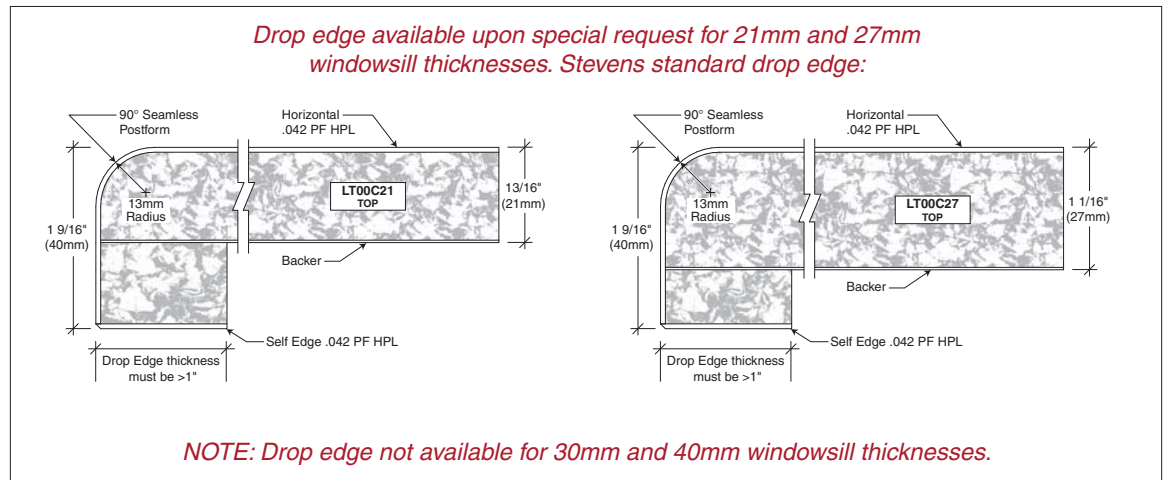

# COUNTERTOPS

Laminate Series

LT = Laminate Top



## LS52

Example:  
LS52C27

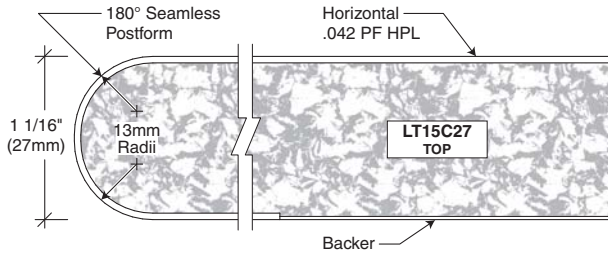

### LS52 LAMINATE WINDOWSILL

- 180° postform edge

#### Series/Core Codes:

- LS52C** CARB particleboard
- LS52M** Moisture-resistant/NAF particleboard
- LS52F** Fire-rated particleboard
- LS52D** Medium Density Fiberboard (MDF)
- LS52G** Moisture-resistant/NAF MDF
- LS52H** Fire-rated MDF

**LS52C, LS52M, LS52F, LS52D, LS52G and LS52H** available windowsill thicknesses:

- ~~21mm (13/16")~~
- 27mm (1-1/16")
- 30mm (1-3/16")
- 40mm (1-9/16") (n/a for LS52H fire-rated MDF)

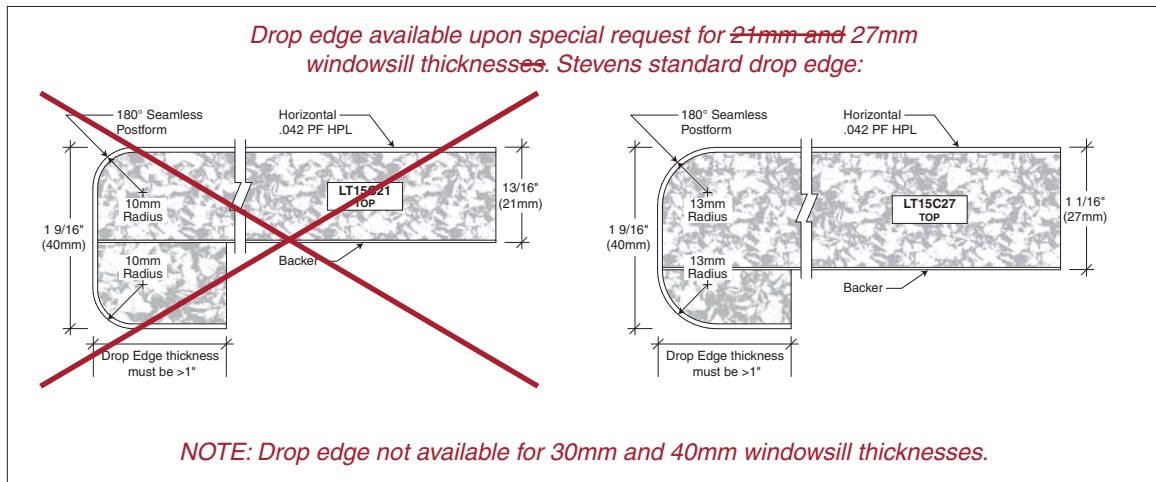



PT = Solid Surface Top

### PS10

Example:  
PS10S12

#### PS10 SOLID SURFACE WINDOWSILL

- Solid surface (polymer) materials
- 3R/3R profile edge

#### Series/Core Code:

PS10S Solid

PS10S available thickness:  
12mm (1/2")

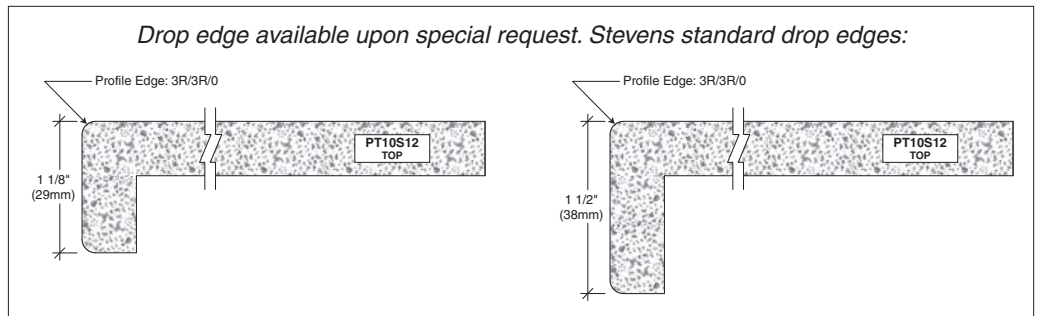
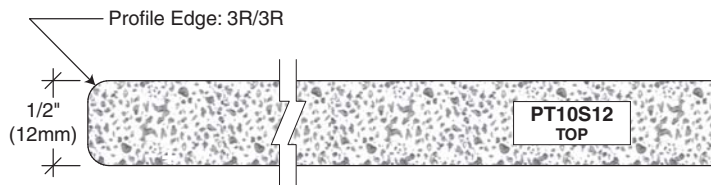

### PS11

Example:  
PS11S12

#### PS11 SOLID SURFACE WINDOWSILL

- Solid surface (polymer) materials
- 3R/.5B profile edge

#### Series/Core Code:

PS11S Solid

PS11S available thickness:  
12mm (1/2")

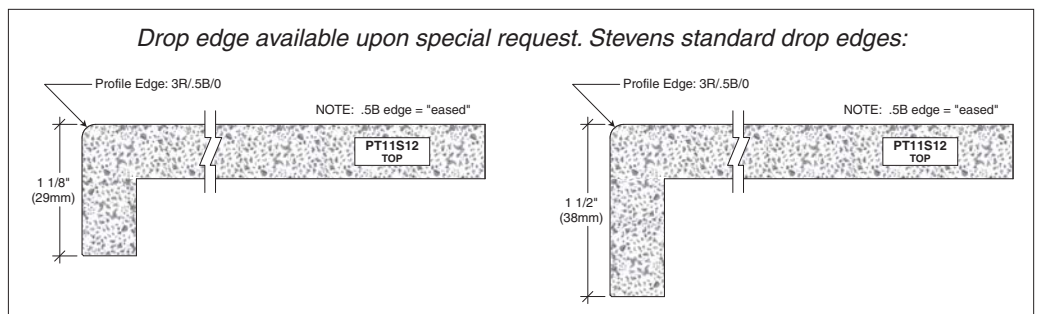
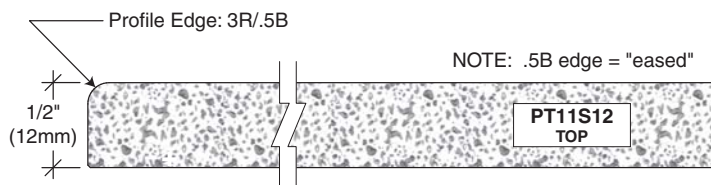

# COUNTERTOPS

## Solid Surface Series

PT = Solid Surface Top



### PS12

Example:  
PS12S12

### PS12 SOLID SURFACE WINDOWSILL

- Solid surface (polymer) materials
- 6R/6R profile edge

#### Series/Core Code:

PS12S Solid

PS12S available thickness:

12mm (1/2")

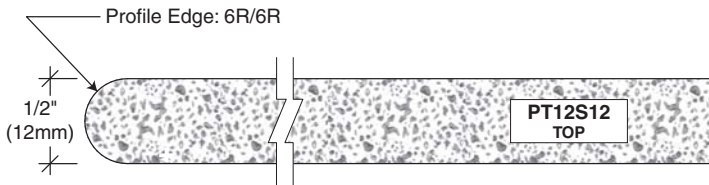

### PS13

Example:  
PS13S12

### PS13 SOLID SURFACE WINDOWSILL

- Solid surface (polymer) materials
- .5B/.5B profile edge

#### Series/Core Code:

PS13S Solid

PS13S available thickness:

12mm (1/2")

