



UPDATE HISTORY

Countertops Section



This UPDATE HISTORY outlines changes made to the Countertops section of the Stevens Advantage Commercial Cabinetry and Millwork catalog since May 2017.

The most recent updates are shown first.

Go to stevensadvantage.com

→ RESOURCES

→ Commercial Casework

to view/download/print
the most current catalog sections.

Later updates supercede earlier updates.

(Revisions shown in **RED**)

UPDATE HISTORY

Countertops Section



DECEMBER 2017			
MODEL #	TYPE OF UPDATE	DESCRIPTION OF UPDATE	CATALOG PAGE #
PS59-PS68, PS72	Description	Changed Backsplash model number to PB72S13; changed Endsplash model number to PE72S13	15-20
PS79-PS88, PS92	Description	Changed Endsplash model number to PE72S13	21-26

OCTOBER 2017			
MODEL #	TYPE OF UPDATE	DESCRIPTION OF UPDATE	CATALOG PAGE #
ES02	Construction/Description	Deleted drip groove	28
ES03	Construction/Description	Deleted drip groove	28



Table of Contents

Terms and Codes 5

COUNTERTOPS

Laminate Series 6-10

LS00: 90° postform edge top, applied 90° postform edge
backsplash, applied self edge endsplash..... 6

LS05: 3mm edge top, applied 3mm edge backsplash and
endsplash..... 6

LS07: Self edge top, applied self edge backsplash and
endsplash..... 7

LS10: 90° postform edge top, integral covered 90° postform edge
backsplash, applied self edge endsplash..... 7

LS11: 3mm edge top, integral covered 3mm edge backsplash,
applied 3mm edge endsplash 8

LS15: 180° postform edge top, applied 90° postform edge
backsplash, applied self edge endsplash..... 8

LS16: 180° postform edge top, integral covered 90° postform
edge backsplash, applied self edge endsplash 9

LS25: Chemsurf face laminate, 3mm edge top, applied 3mm
edge backsplash and endsplash 10

LS26: Chemsurf face laminate, self edge top, applied self edge
backsplash and endsplash 10

**Wood Edge Laminate Series: Profile wood edge top,
applied 90° postform edge
backsplash, applied self edge
endsplash..... 11-14**

LS60: 3R/3R profile top 11

LS64: 6R/6R profile top 11

LS65: 12B/0 profile top 12

LS67: 12R/0 profile top 12

LS68: 12R/12R profile top 13

LS70: Bullnose profile top 13

LS71: 6R/0 profile top 14

**Solid Surface Series: Profile edge top, applied .5B/0 profile
edge backsplash and endsplash 15-20**

PS59: 3R/3R profile top 15

PS60: 3R/.5B profile top 15

PS61: 6B/.5B profile top 16

PS62: 6B/6B profile top 16

PS63: 6R/.5B profile top 17

PS64: 6R/6R profile top 17

PS65: 12B/.5B profile top 18

PS66: 12R/.5B profile top 18

PS67: 12R/6R profile top 19

PS68: 12R/12R profile top 19

PS72: .5B/.5B profile top 20

(continued on page 2)



Table of Contents *(continued)*

Solid Surface Series: Profile edge top, integral covered .5B/0 profile edge backsplash, applied .5B/0 profile edge endsplash	21-26
PS79: 3R/3R profile top	21
PS80: 3R/.5B profile top	21
PS81: 6B/.5B profile top	22
PS82: 6B/6B profile top	22
PS83: 6R/.5B profile top	23
PS84: 6R/6R profile top	23
PS85: 12B/.5B profile top	24
PS86: 12R/.5B profile top	24
PS87: 12R/6R profile top	25
PS88: 12R/12R profile top	25
PS92: .5B/.5B profile top	26
 Epoxy Resin Series: 3mm bevel/radius edges	27-28
ES00: Applied backsplash and endsplash	27
ES01: Integral covered backsplash, applied endsplash	27
ES02: Lipped marine edge top, applied backsplash and endsplash	28
ES03: Lipped marine edge top, integral covered backsplash, applied endsplash	28
 Hardwood Series	29
WD00	29
 Workbench Series	30
BW00	30
 Stainless Steel Series	31-32
SS00: Formed edge	31
SS01: Marine edge	32
 Phenolic Series	33-35
AP00: Decorative face	33
AP01: Black acid resistant face	33
AP02: Decorative acid resistant face	34
AP03: Decorative face, drip groove	34
AP04: Black acid resistant face, drip groove	35
AP05: Decorative acid resistant face, drip groove	35
 Granite Series: Applied straight polish profile edge backsplash and endsplash	36-37
GS00: Straight polish/straight polish profile edge top	36
GS01: Bevel ±1/4"/straight polish profile edge top	36
GS02: Half bullnose/straight polish profile edge top	37

(continued on page 3)



Table of Contents *(continued)*

Marble Series: Applied straight polish profile edge backsplash and endsplash **38-39**

- MS00: Straight polish/straight polish profile edge top 38
- MS01: Bevel ±1/4"/straight polish profile edge top..... 38
- MS02: Half bullnose/straight polish profile edge top 39

Quartz Series: Applied straight polish profile edge backsplash and endsplash **40-41**

- QS00: Straight polish/straight polish profile edge top 40
- QS01: Bevel ±1/4"/straight polish profile edge top..... 40
- QS02: Half bullnose/straight polish profile edge top 41

WINDOWSILLS

Laminate Series..... **42-44**

- LS50: Self edge 42
- LS51: 90° postform edge 43
- LS52: 180° postform edge 44

Solid Surface Series..... **45-46**

- PS10: 3R/3R profile edge 45
- PS11: 3R/.5B profile edge 45
- PS12: 6R/6R profile edge 46
- PS13: .5B/.5B profile edge..... 46

COUNTERTOPS

Commercial Cabinetry and Millwork





Stevens Industries, Inc., from its initial founding in 1956, has provided a complete solution of cabinets and countertops fabricated and coordinated as a full product offering. Stevens Advantage countertops, included with the wide range of cabinets and millwork, can complete the entire project's requirements. Countertops are available in several versions of laminate, solid surface (polymer), epoxy resin, hardwood, stainless steel, phenolic, granite, marble and quartz. The following technical descriptions and design data illustrate the available designs. Beyond those shown, Stevens Millwork can also provide unique special applications.

GLOSSARY OF TERMS:

3mm Edge:	Edge with high impact 3mm (1/8") thickness extrusion (patterns available from Stevens standard offering)
90° Postform:	Seamless formed high pressure laminate wrapped over a 90° radius profile (eliminates brown edges and separate applied edge strips)
180° Postform:	Seamless formed high pressure laminate wrapped over a 180° profile (eliminates brown edges and separate applied edge strips)
Backer:	Back underside faced with laminate backer
CARB:	California Air Resources Board
Chemsurf:	Chemical resistant laminate
HGS:	Horizontal Grade Standard
HPL:	Face surfacing in high pressure laminate
Integral Cove:	Backsplash with a concave formed seamless intersection between countertop and backsplash
Marine Edge:	Raised outside countertop edge
MDF:	Medium density fiberboard
NAF:	No added formaldehyde
Self Edge:	Edges laminated with same high pressure laminate as countertop face

COUNTERTOP PREFIX CODES:

AP:	Phenolic
BW:	Laminated Workbench
ES:	Epoxy Resin
GS:	Granite
LS:	Laminate
MS:	Marble
PS:	Solid Surface (Polymer)
QS:	Quartz
SS:	Stainless Steel
WD:	Laminated Hardwood (Butcher Block)

COUNTERTOP CORE/SUBSTRATE CODES:

C:	CARB particleboard
F:	Fire-rated particleboard
M:	Moisture-resistant/NAF particleboard
P:	Plywood
R:	Rail
S:	Solid

COUNTERTOPS

Laminate Series

LT = Laminate Top
 LB = Laminate Backsplash
 LE = Laminate Endsplash



LS00

Example:
 LS00C2721

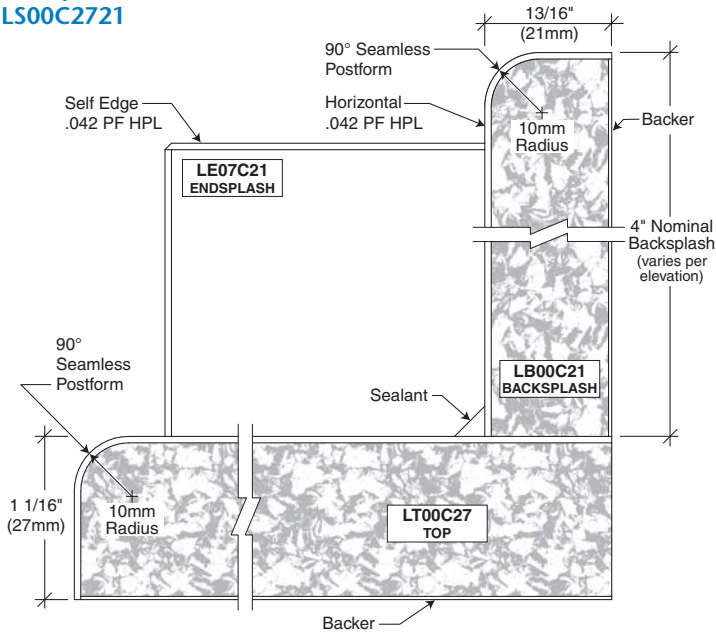

LS00 LAMINATE

- 90° postform edge top
- Applied 90° postform edge backsplash
- Applied self edge endsplash

Series/Core Codes:

- LS00C** CARB particleboard
LS00M Moisture-resistant/NAF particleboard
LS00F Fire-rated particleboard

LS00C, LS00M and LS00F available countertop thicknesses:

- 21mm (13/16")
- 27mm (1-1/16")
- 40mm (1-9/16")

LS00C special order countertop thickness:
 30mm (1-3/16")

LS05

Example:
 LS05C2721

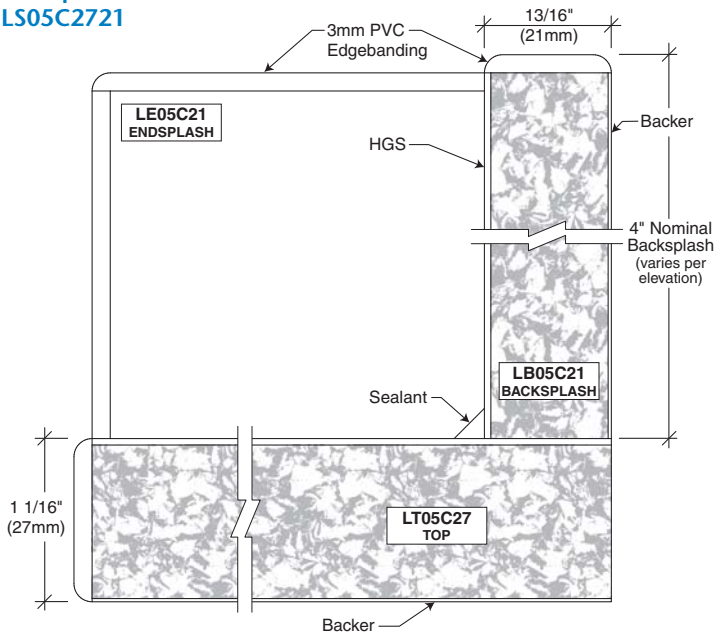

LS05 LAMINATE

- 3mm edge top
- Applied 3mm edge backsplash and endsplash

Series/Core Codes:

- LS05C** CARB particleboard
LS05M Moisture-resistant/NAF particleboard
LS05F Fire-rated particleboard
LS05P Plywood

LS05C, LS05M and LS05F available countertop thicknesses:

- 21mm (13/16")
- 27mm (1-1/16")
- 40mm (1-9/16") (*edges: specific patterns only*)

LS05C special order countertop thickness:
 30mm (1-3/16")

LS05P available countertop thicknesses:
 20mm (3/4")
 27mm (1-1/16")
 40mm (1-9/16") (*edges: specific patterns only*)

LT = Laminate Top
LB = Laminate Backsplash
LE = Laminate Endsplash

LS07

Example:
LS07C2721

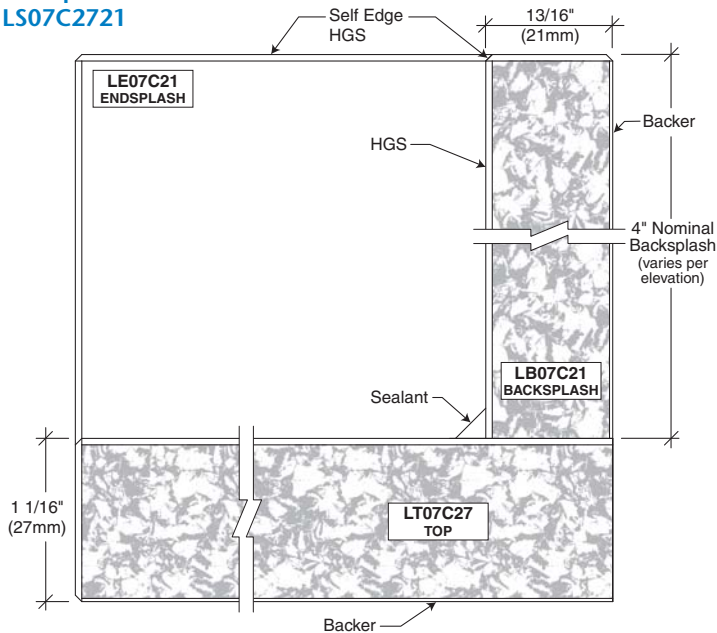

LS07 LAMINATE

- Self edge top
- Applied self edge backsplash and endsplash

Series/Core Codes:

LS07C CARB particleboard
LS07M Moisture-resistant/NAF particleboard
LS07F Fire-rated particleboard
LS07P Plywood

LS07C, LS07M and LS07F available countertop thicknesses:

21mm (13/16")
27mm (1-1/16")
40mm (1-9/16")

LS07C special order countertop thickness:
30mm (1-3/16")

LS07P available countertop thicknesses:
20mm (3/4")
27mm (1-1/16")
40mm (1-9/16")

LS10

Example:
LS10C2721

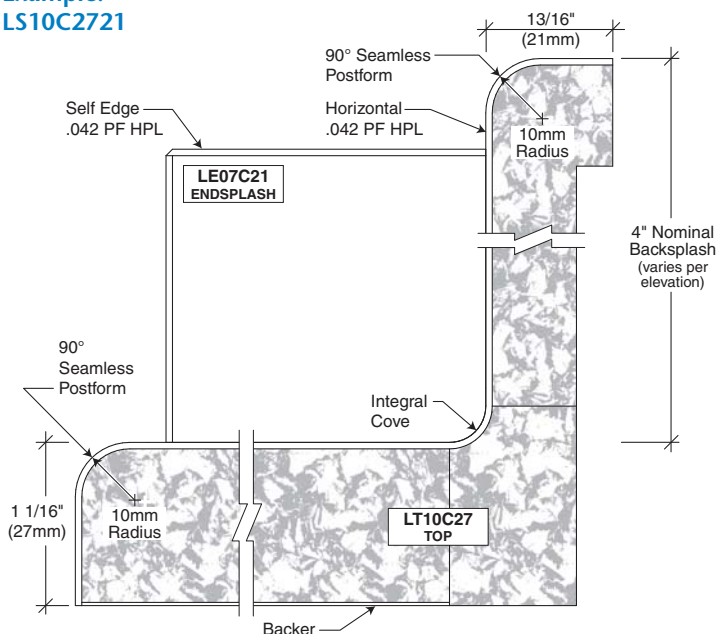

LS10 LAMINATE

- 90° postform edge top
- Integral coved 90° postform edge backsplash
- Applied self edge endsplash

Series/Core Codes:

LS10C CARB particleboard
LS10M Moisture-resistant/NAF particleboard
LS10F Fire-rated particleboard

LS10C, LS10M and LS10F available countertop thicknesses:

21mm (13/16")
27mm (1-1/16")
40mm (1-9/16")

LS10C special order countertop thickness:
30mm (1-3/16")

COUNTERTOPS

Laminate Series

LT = Laminate Top
 LB = Laminate Backsplash
 LE = Laminate Endsplash



LS11

Example:
 LS11C2721

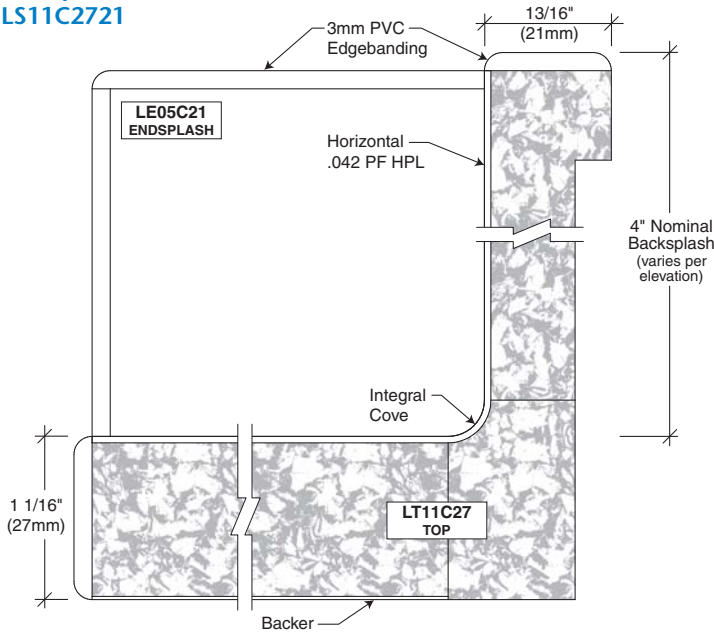

LS11 LAMINATE

- 3mm edge top
- Integral coved 3mm edge backsplash
- Applied 3mm edge endsplash

Series/Core Codes:

- LS11C CARB particleboard
- LS11M Moisture-resistant/NAF particleboard
- LS11F Fire-rated particleboard
- LS11P Plywood

LS11C, LS11M and LS11F available countertop thicknesses:

- 21mm (13/16")
- 27mm (1-1/16")
- 40mm (1-9/16") (edges: specific patterns only)

LS11C special order countertop thickness:
 30mm (1-3/16")

LS11P available countertop thicknesses:

- 20mm (3/4")
- 27mm (1-1/16")
- 40mm (1-9/16") (edges: specific patterns only)

LS15

Example:
 LS15C2721

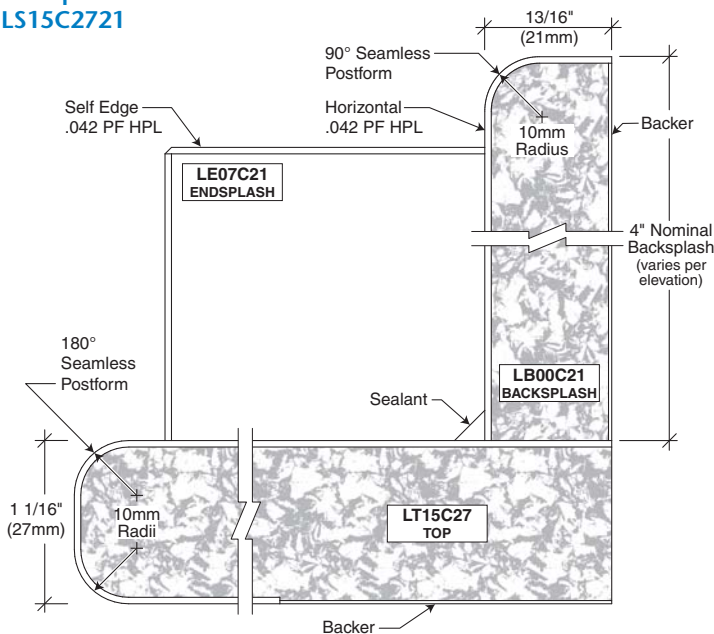

LS15 LAMINATE

- 180° postform edge top
- Applied 90° postform edge backsplash
- Applied self edge endsplash

Series/Core Codes:

- LS15C CARB particleboard
- LS15M Moisture-resistant/NAF particleboard
- LS15F Fire-rated particleboard

LS15C, LS15M and LS15F available countertop thicknesses:

- 21mm (13/16")
- 27mm (1-1/16")
- 40mm (1-9/16")

LS15C special order countertop thickness:
 30mm (1-3/16")

LT = Laminate Top
LB = Laminate Backsplash
LE = Laminate Endsplash

LS16

Example:
LS16C2721

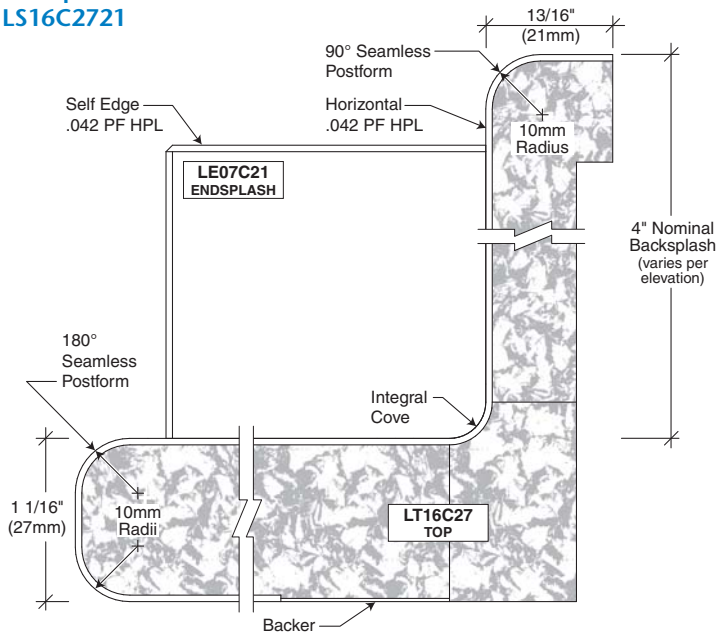

LS16 LAMINATE

- 180° postform edge top
- Integral coved 90° postform edge backsplash
- Applied self edge endsplash

Series/Core Codes:

- LS16C** CARB particleboard
- LS16M** Moisture-resistant/NAF particleboard
- LS16F** Fire-rated particleboard

LS16C, LS16M and LS16F available countertop thicknesses:

- 21mm (13/16")
- 27mm (1-1/16")
- 40mm (1-9/16")

LS16C special order countertop thickness:
30mm (1-3/16")

COUNTERTOPS

Laminate Series Chemsurf

LT = Laminate Top
LB = Laminate Backsplash
LE = Laminate Endsplash



LS25

Example:
LS25C2721

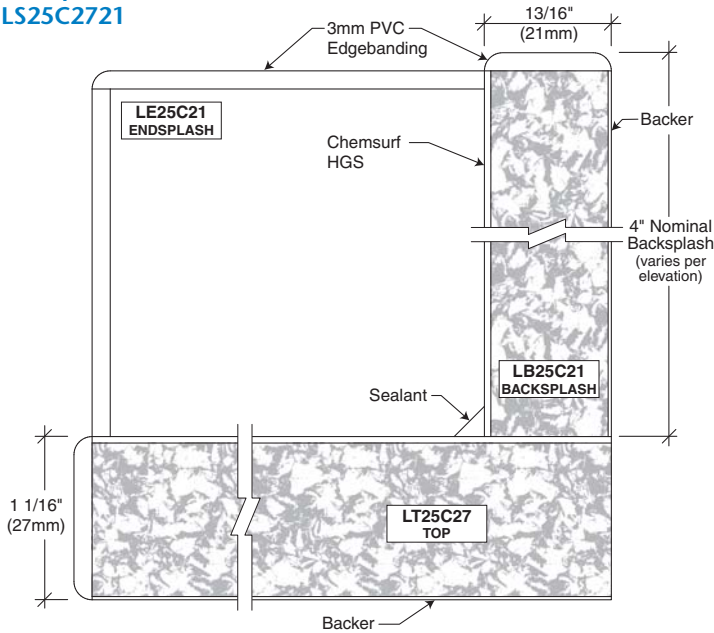

LS25 LAMINATE

- Chemsurf face laminate
- 3mm edge top
- Applied 3mm edge backsplash and endsplash

Series/Core Codes:

- LS25C** CARB particleboard
LS25M Moisture-resistant/NAF particleboard
LS25F Fire-rated particleboard
LS25P Plywood

LS25C, LS25M and LS25F available countertop thicknesses:

- 21mm (13/16")
- 27mm (1-1/16")
- 40mm (1-9/16") (*edges: specific patterns only*)

LS25C special order countertop thickness:
30mm (1-3/16")

LS25P available countertop thicknesses:

- 20mm (3/4")
- 27mm (1-1/16")
- 40mm (1-9/16") (*edges: specific patterns only*)

LS26

Example:
LS26C2721

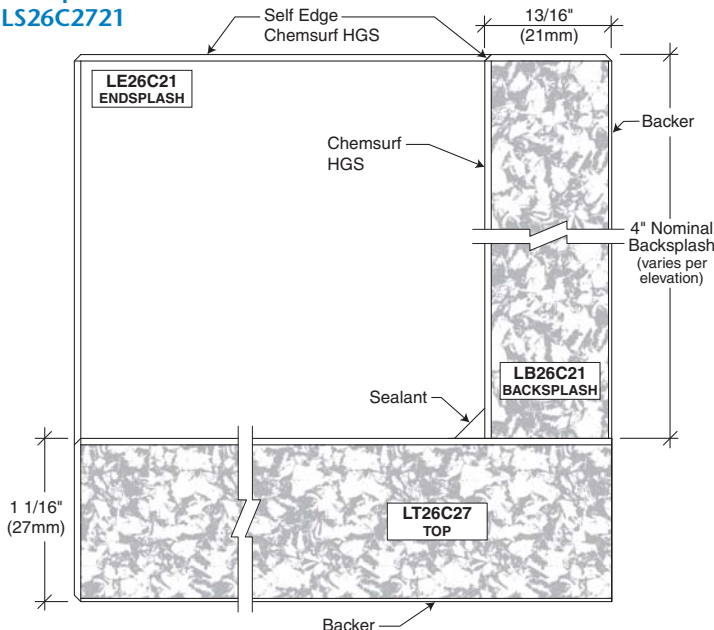

LS26 LAMINATE

- Chemsurf face laminate
- Self edge top
- Applied self edge backsplash and endsplash

Series/Core Codes:

- LS26C** CARB particleboard
LS26M Moisture-resistant/NAF particleboard
LS26F Fire-rated particleboard
LS26P Plywood

LS26C, LS26M and LS26F available countertop thicknesses:

- 21mm (13/16")
- 27mm (1-1/16")
- 40mm (1-9/16")

LS26C special order countertop thickness:
30mm (1-3/16")

LS26P available countertop thicknesses:

- 20mm (3/4")
- 27mm (1-1/16")
- 40mm (1-9/16")

LT = Laminate Top
LB = Laminate Backsplash
LE = Laminate Endsplash

LS60

(Stevens preferred)

Example:
LS60C2721

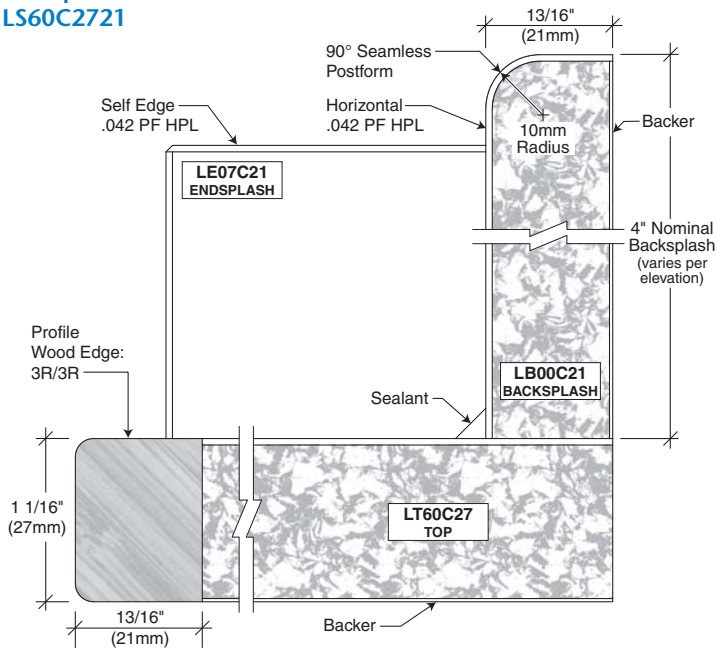

LS60 LAMINATE WITH WOOD EDGE

- 3R/3R profile wood edge top
- Applied 90° postform edge backsplash
- Applied self edge endsplash

Series/Core Codes:

- LS60C** CARB particleboard
- LS60M** Moisture-resistant/NAF particleboard
- LS60F** Fire-rated particleboard

LS60C, LS60M and **LS60F** available countertop thicknesses:

- 21mm (13/16")
- 27mm (1-1/16")
- 40mm (1-9/16")

LS60C special order countertop thickness:
30mm (1-3/16")

Wood Edge available species and finishes:

- Species: maple, red oak, cherry
- Finishes: Stevens current standards

LS64

Example:
LS64C2721

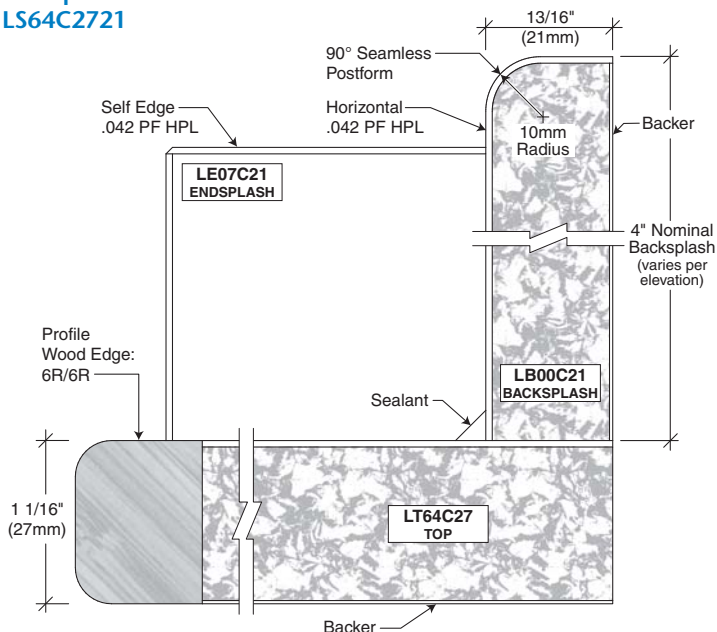

LS64 LAMINATE WITH WOOD EDGE

- 6R/6R profile wood edge top
- Applied 90° postform edge backsplash
- Applied self edge endsplash

Series/Core Codes:

- LS64C** CARB particleboard
- LS64M** Moisture-resistant/NAF particleboard
- LS64F** Fire-rated particleboard

LS64C, LS64M and **LS64F** available countertop thicknesses:

- 21mm (13/16")
- 27mm (1-1/16")
- 40mm (1-9/16")

LS64C special order countertop thickness:
30mm (1-3/16")

Wood Edge available species and finishes:

- Species: maple, red oak, cherry
- Finishes: Stevens current standards

COUNTERTOPS

Laminate Series Wood Edge Top

LT = Laminate Top
LB = Laminate Backsplash
LE = Laminate Endsplash



LS65

Example:
LS65C2721

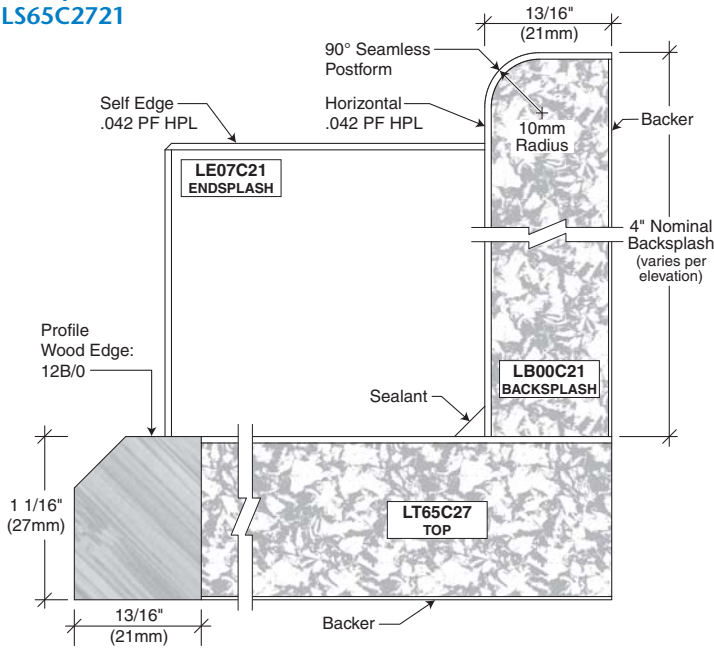

LS65 LAMINATE WITH WOOD EDGE

- 12B/0 profile wood edge top
- Applied 90° postform edge backsplash
- Applied self edge endsplash

Series/Core Codes:

- LS65C** CARB particleboard
- LS65M** Moisture-resistant/NAF particleboard
- LS65F** Fire-rated particleboard

LS65C, LS65M and LS65F available countertop thicknesses:

- 21mm (13/16")
- 27mm (1-1/16")
- 40mm (1-9/16")

LS65C special order countertop thickness:
30mm (1-3/16")

Wood Edge available species and finishes:

- Species: maple, red oak, cherry
- Finishes: Stevens current standards

LS67

Example:
LS67C2721

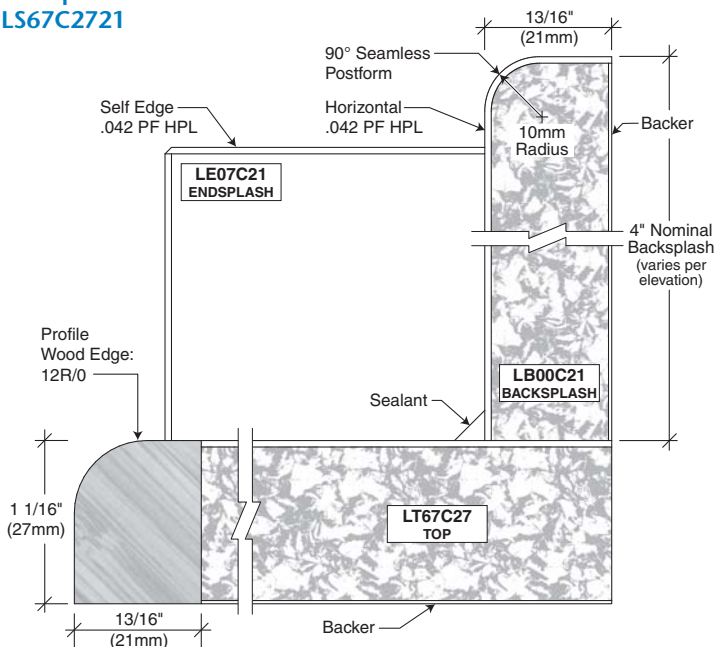

LS67 LAMINATE WITH WOOD EDGE

- 12R/0 profile wood edge top
- Applied 90° postform edge backsplash
- Applied self edge endsplash

Series/Core Codes:

- LS67C** CARB particleboard
- LS67M** Moisture-resistant/NAF particleboard
- LS67F** Fire-rated particleboard

LS67C, LS67M and LS67F available countertop thicknesses:

- 21mm (13/16")
- 27mm (1-1/16")
- 40mm (1-9/16")

LS67C special order countertop thickness:
30mm (1-3/16")

Wood Edge available species and finishes:

- Species: maple, red oak, cherry
- Finishes: Stevens current standards

LT = Laminate Top
LB = Laminate Backsplash
LE = Laminate Endsplash

LS68

Example:
LS68C2721

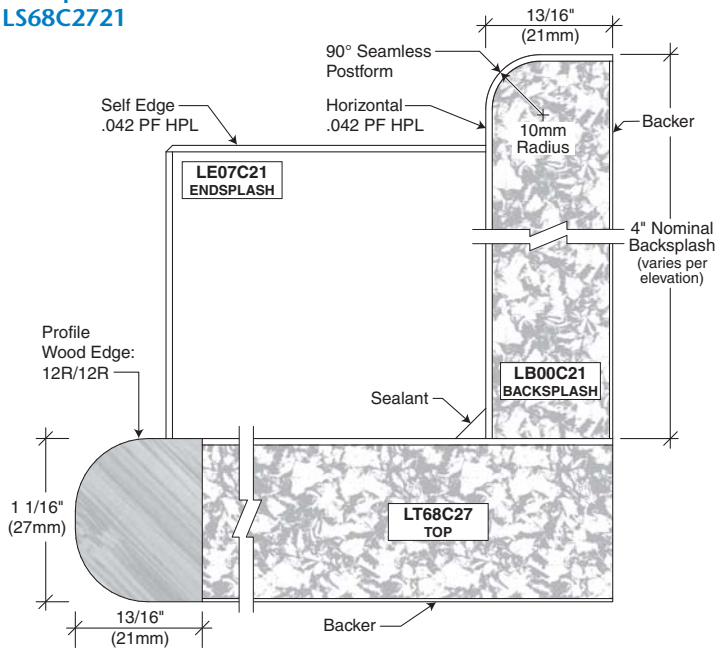

LS68 LAMINATE WITH WOOD EDGE

- 12R/12R profile wood edge top
- Applied 90° postform edge backsplash
- Applied self edge endsplash

Series/Core Codes:

- LS68C** CARB particleboard
LS68M Moisture-resistant/NAF particleboard
LS68F Fire-rated particleboard

LS68C, LS68M and **LS68F** available countertop thicknesses:

- 27mm (1-1/16")
- 40mm (1-9/16")

LS68C special order countertop thickness:
30mm (1-3/16")

Wood Edge available species and finishes:

- Species: maple, red oak, cherry
- Finishes: Stevens current standards

LS70

Example:
LS70C2721

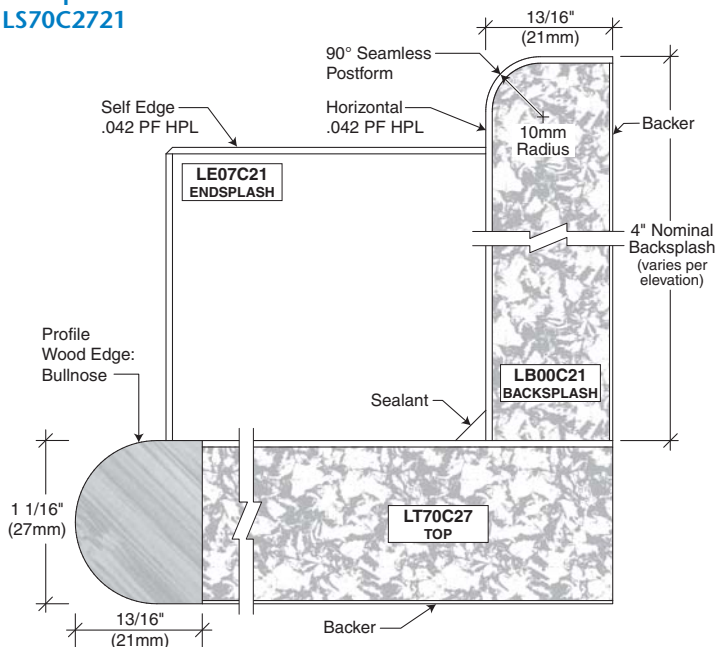

LS70 LAMINATE WITH WOOD EDGE

- Bullnose profile wood edge top
- Applied 90° postform edge backsplash
- Applied self edge endsplash

Series/Core Codes:

- LS70C** CARB particleboard
LS70M Moisture-resistant/NAF particleboard
LS70F Fire-rated particleboard

LS70C, LS70M and **LS70F** available countertop thicknesses:

- 21mm (13/16")
- 27mm (1-1/16")

LS70C special order countertop thickness:
30mm (1-3/16")

Wood Edge available species and finishes:

- Species: maple, red oak, cherry
- Finishes: Stevens current standards

COUNTERTOPS

Laminate Series Wood Edge Top

LT = Laminate Top
LB = Laminate Backsplash
LE = Laminate Endsplash



LS71

Example:
LS71C2721

LS71 LAMINATE WITH WOOD EDGE

- 6R/0 profile wood edge top
- Applied 90° postform edge backsplash
- Applied self edge endsplash

Series/Core Codes:

- LS71C** CARB particleboard
LS71M Moisture-resistant/NAF particleboard
LS71F Fire-rated particleboard

LS71C, LS71M and LS71F available countertop thicknesses:

- 21mm (13/16")
- 27mm (1-1/16")
- 40mm (1-9/16")

LS71C special order countertop thickness:
30mm (1-3/16")

Wood Edge available species and finishes:

- Species: maple, red oak, cherry
- Finishes: Stevens current standards

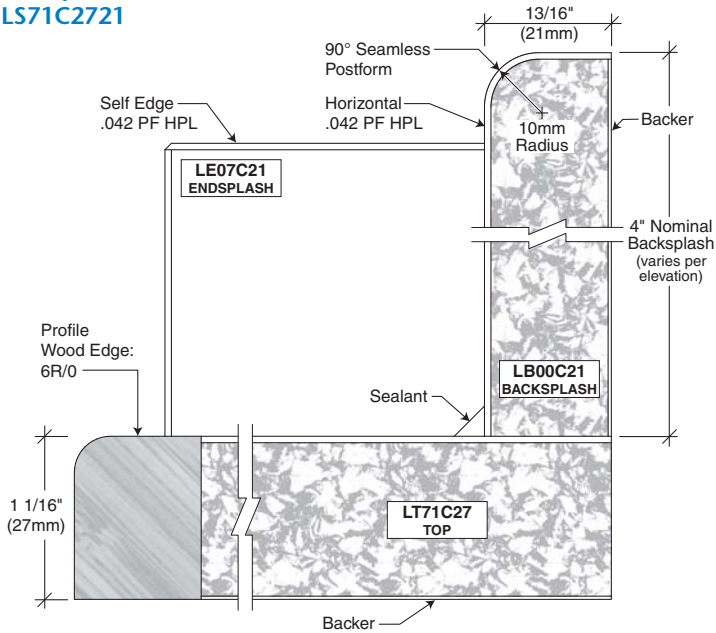

PT = Solid Surface Top
PB = Solid Surface Backsplash
PE = Solid Surface Endsplash

PS59

(Stevens preferred)

Example:
PS59C2913

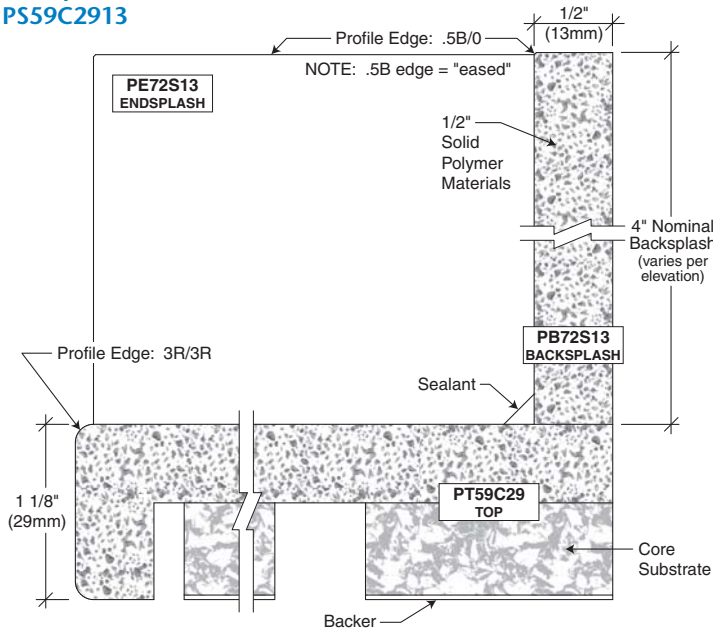

PS59 SOLID SURFACE

- Solid surface (polymer) materials
- 3R/3R profile edge top
- Applied .5B/0 profile edge backsplash and endsplash

Series/Core Substrate Codes:

- PS59C** CARB particleboard
- PS59M** Moisture-resistant/NAF particleboard
- PS59F** Fire-rated particleboard
- PS59P** Plywood

PS59C, PS59M, PS59F and PS59P available countertop thicknesses:
29mm (1-1/8")
38mm (1-1/2")

Drop edge available upon special request.

PS60

Example:
PS60C2913

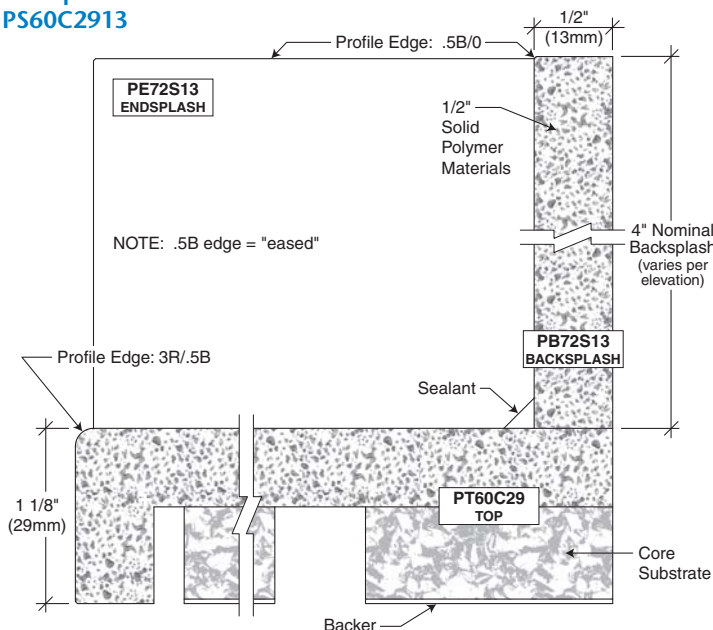

PS60 SOLID SURFACE

- Solid surface (polymer) materials
- 3R/.5B profile edge top
- Applied .5B/0 profile edge backsplash and endsplash

Series/Core Substrate Codes:

- PS60C** CARB particleboard
- PS60M** Moisture-resistant/NAF particleboard
- PS60F** Fire-rated particleboard
- PS60P** Plywood

PS60C, PS60M, PS60F and PS60P available countertop thicknesses:
29mm (1-1/8")
38mm (1-1/2")

Drop edge available upon special request.

COUNTERTOPS

Solid Surface Series

PT = Solid Surface Top
 PB = Solid Surface Backsplash
 PE = Solid Surface Endsplash



PS61

Example:
 PS61C2913

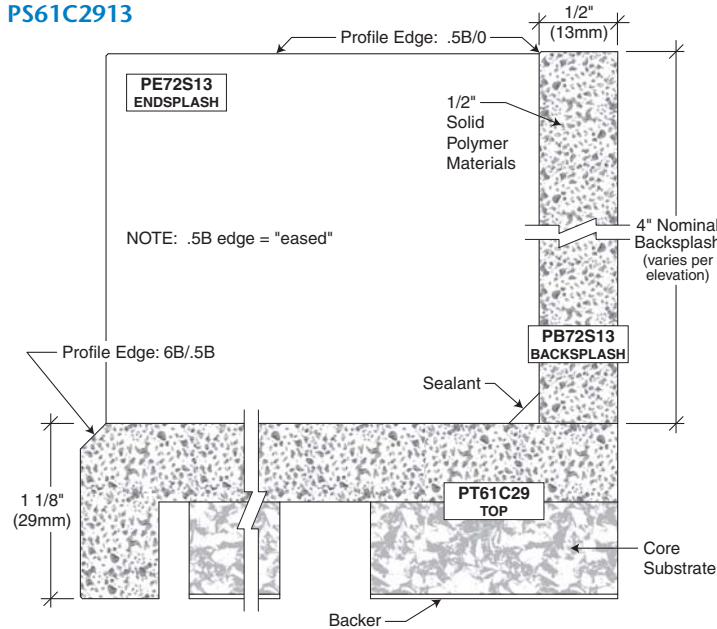

PS61 SOLID SURFACE

- Solid surface (polymer) materials
- 6B/.5B profile edge top
- Applied .5B/0 profile edge backsplash and endsplash

Series/Core Substrate Codes:

- PS61C** CARB particleboard
PS61M Moisture-resistant/NAF particleboard
PS61F Fire-rated particleboard
PS61P Plywood

PS61C, PS61M, PS61F and PS61P available countertop thicknesses:
 29mm (1-1/8")
 38mm (1-1/2")

Drop edge available upon special request.

PS62

Example:
 PS62C2913

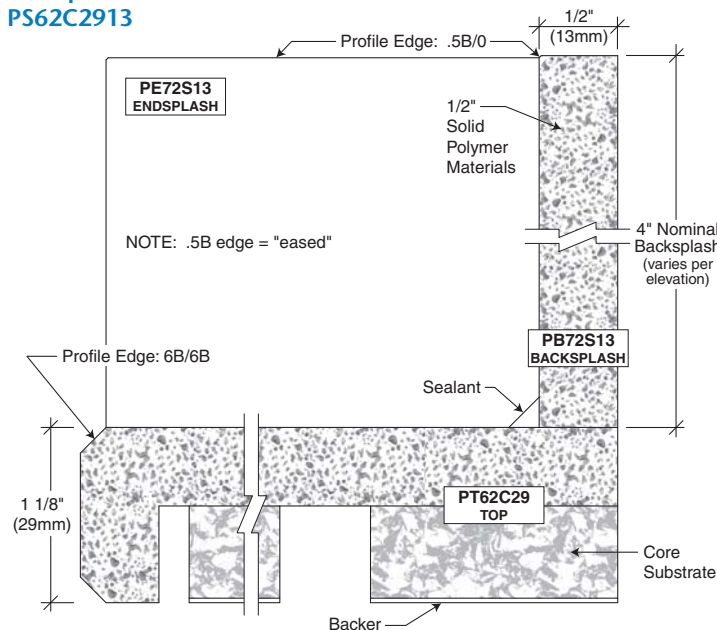

PS62 SOLID SURFACE

- Solid surface (polymer) materials
- 6B/6B profile edge top
- Applied .5B/0 profile edge backsplash and endsplash

Series/Core Substrate Codes:

- PS62C** CARB particleboard
PS62M Moisture-resistant/NAF particleboard
PS62F Fire-rated particleboard
PS62P Plywood

PS62C, PS62M, PS62F and PS62P available countertop thicknesses:
 29mm (1-1/8")
 38mm (1-1/2")

Drop edge available upon special request.

PT = Solid Surface Top
PB = Solid Surface Backsplash
PE = Solid Surface Endsplash

PS63

Example:
PS63C2913

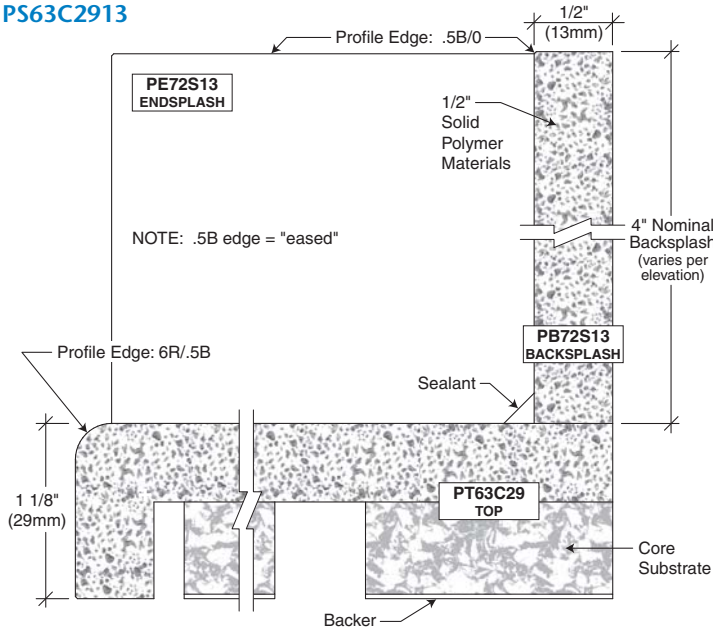

PS63 SOLID SURFACE

- Solid surface (polymer) materials
- 6R/.5B profile edge top
- Applied .5B/0 profile edge backsplash and endsplash

Series/Core Substrate Codes:

- PS63C** CARB particleboard
- PS63M** Moisture-resistant/NAF particleboard
- PS63F** Fire-rated particleboard
- PS63P** Plywood

PS63C, PS63M, PS63F and PS63P available countertop thicknesses:
29mm (1-1/8")
38mm (1-1/2")

Drop edge available upon special request.

PS64

Example:
PS64C2913

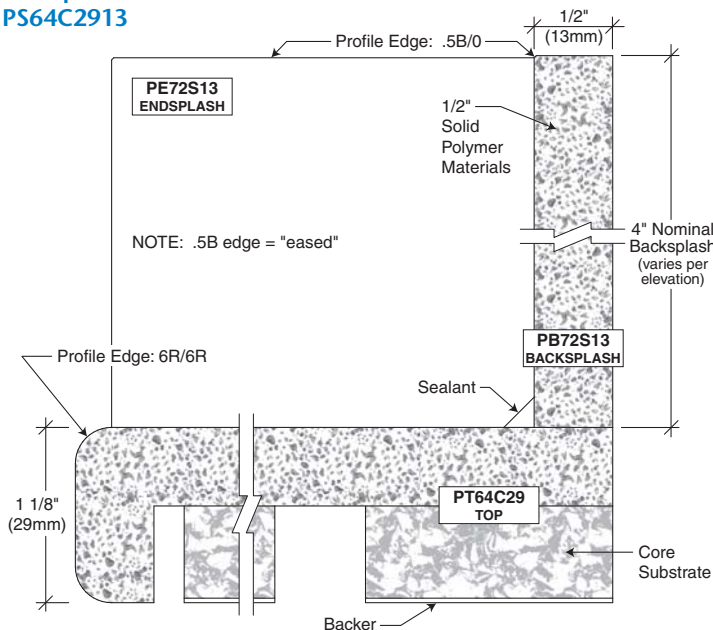

PS64 SOLID SURFACE

- Solid surface (polymer) materials
- 6R/6R profile edge top
- Applied .5B/0 profile edge backsplash and endsplash

Series/Core Substrate Codes:

- PS64C** CARB particleboard
- PS64M** Moisture-resistant/NAF particleboard
- PS64F** Fire-rated particleboard
- PS64P** Plywood

PS64C, PS64M, PS64F and PS64P available countertop thicknesses:
29mm (1-1/8")
38mm (1-1/2")

Drop edge available upon special request.

COUNTERTOPS

Solid Surface Series

PT = Solid Surface Top
 PB = Solid Surface Backsplash
 PE = Solid Surface Endsplash



PS65

Example:
 PS65C2913

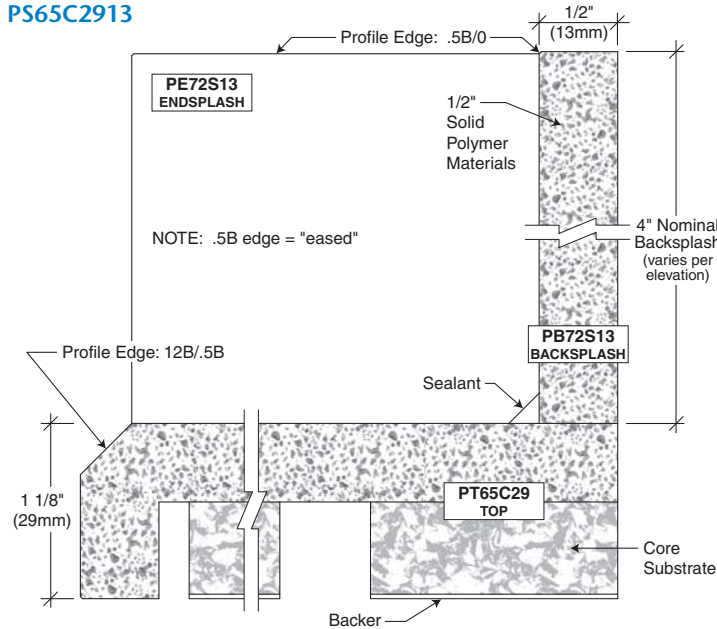

PS65 SOLID SURFACE

- Solid surface (polymer) materials
- 12B/.5B profile edge top
- Applied .5B/0 profile edge backsplash and endsplash

Series/Core Substrate Codes:

- PS65C** CARB particleboard
- PS65M** Moisture-resistant/NAF particleboard
- PS65F** Fire-rated particleboard
- PS65P** Plywood

PS65C, PS65M, PS65F and PS65P available countertop thicknesses:
 29mm (1-1/8")
 38mm (1-1/2")

Drop edge available upon special request.

PS66

Example:
 PS66C2913

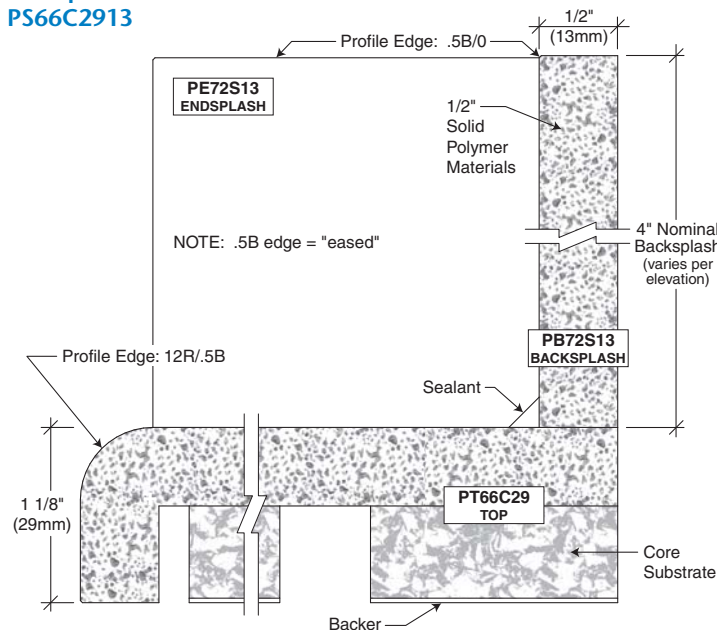

PS66 SOLID SURFACE

- Solid surface (polymer) materials
- 12R/.5B profile edge top
- Applied .5B/0 profile edge backsplash and endsplash

Series/Core Substrate Codes:

- PS66C** CARB particleboard
- PS66M** Moisture-resistant/NAF particleboard
- PS66F** Fire-rated particleboard
- PS66P** Plywood

PS66C, PS66M, PS66F and PS66P available countertop thicknesses:
 29mm (1-1/8")
 38mm (1-1/2")

Drop edge available upon special request.

PT = Solid Surface Top
PB = Solid Surface Backsplash
PE = Solid Surface Endsplash

PS67

Example:
PS67C2913

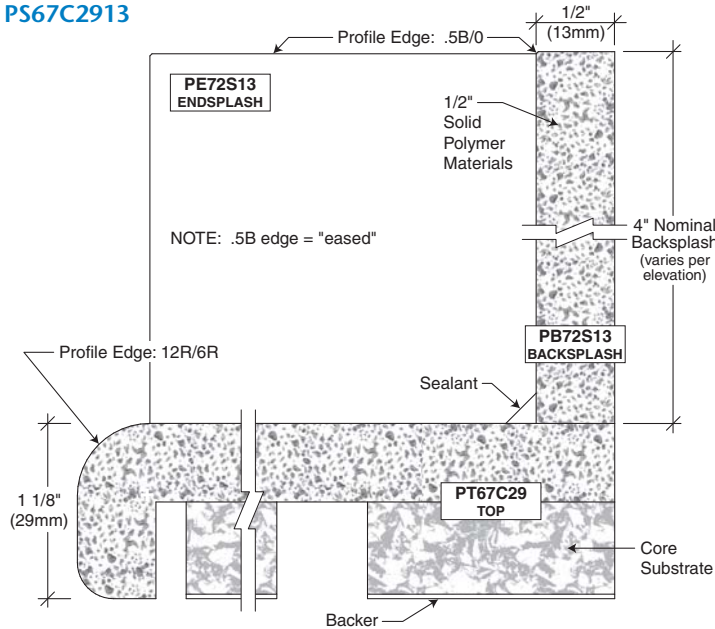

PS67 SOLID SURFACE

- Solid surface (polymer) materials
- 12R/6R profile edge top
- Applied .5B/0 profile edge backsplash and endsplash

Series/Core Substrate Codes:

- PS67C** CARB particleboard
PS67M Moisture-resistant/NAF particleboard
PS67F Fire-rated particleboard
PS67P Plywood

PS67C, PS67M, PS67F and PS67P available countertop thicknesses:
29mm (1-1/8")
38mm (1-1/2")

Drop edge available upon special request.

PS68

Example:
PS68C2913

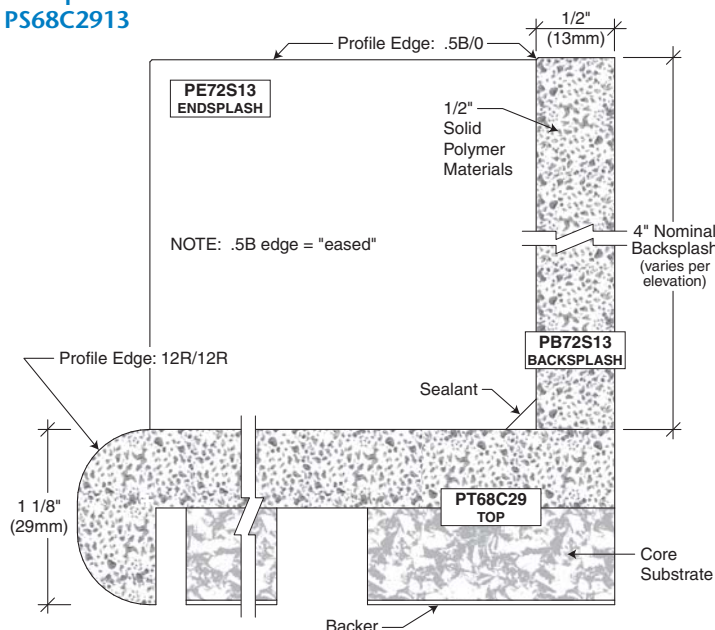

PS68 SOLID SURFACE

- Solid surface (polymer) materials
- 12R/12R profile edge top
- Applied .5B/0 profile edge backsplash and endsplash

Series/Core Substrate Codes:

- PS68C** CARB particleboard
PS68M Moisture-resistant/NAF particleboard
PS68F Fire-rated particleboard
PS68P Plywood

PS68C, PS68M, PS68F and PS68P available countertop thicknesses:
29mm (1-1/8")
38mm (1-1/2")

Drop edge available upon special request.

COUNTERTOPS

Solid Surface Series

PT = Solid Surface Top
PB = Solid Surface Backsplash
PE = Solid Surface Endsplash



PS72

Example:
PS72C2913

PS72 SOLID SURFACE

- Solid surface (polymer) materials
- .5B/.5B profile edge top
- Applied .5B/0 profile edge backsplash and endsplash

Series/Core Substrate Codes:

PS72C CARB particleboard
PS72M Moisture-resistant/NAF particleboard
PS72F Fire-rated particleboard
PS72P Plywood

PS72C, PS72M, PS72F and PS72P available countertop thicknesses:
29mm (1-1/8")
38mm (1-1/2")

Drop edge available upon special request.

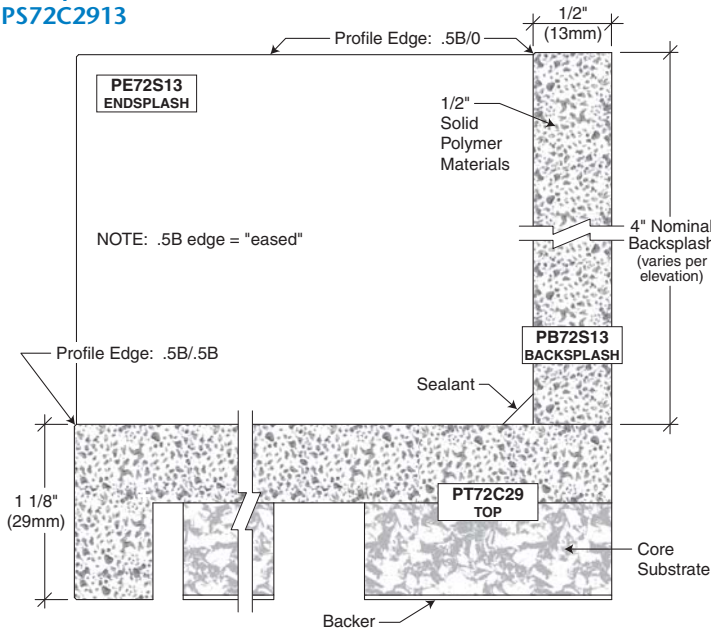

PT = Solid Surface Top
PE = Solid Surface Endsplash

PS79

(Stevens preferred)

Example:
PS79C2913

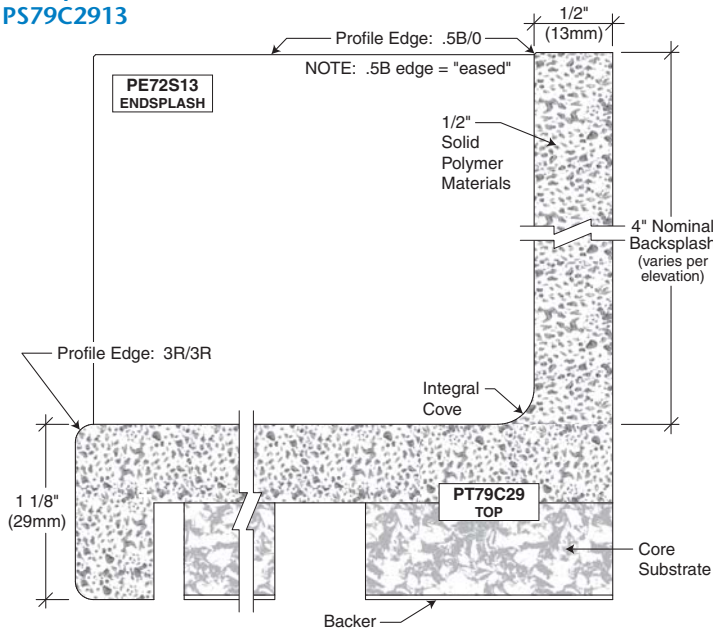

PS79 SOLID SURFACE

- Solid surface (polymer) materials
- 3R/3R profile edge top
- Integral covered .5B/0 profile edge backplash
- Applied .5B/0 profile edge endsplash

Series/Core Substrate Codes:

- PS79C** CARB particleboard
- PS79M** Moisture-resistant/NAF particleboard
- PS79F** Fire-rated particleboard
- PS79P** Plywood

PS79C, PS79M, PS79F and PS79P available countertop thicknesses:
29mm (1-1/8")
38mm (1-1/2")

Drop edge available upon special request.

PS80

Example:
PS80C2913

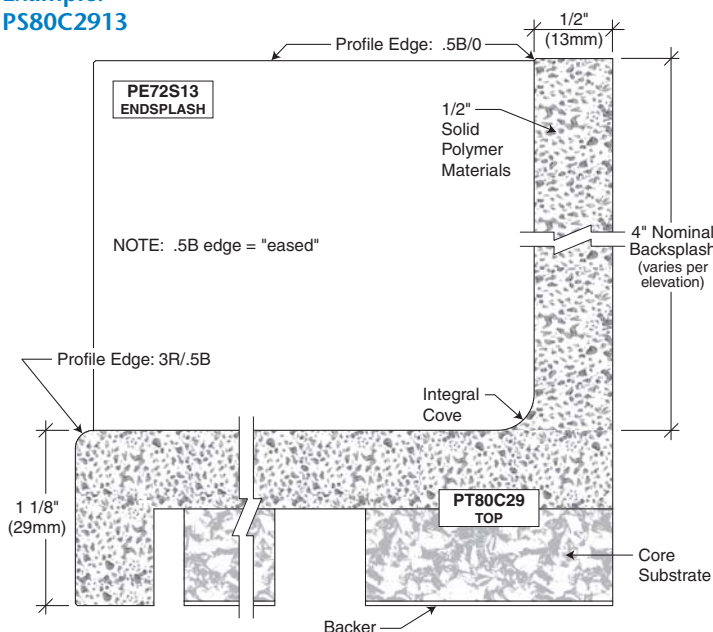

PS80 SOLID SURFACE

- Solid surface (polymer) materials
- 3R/.5B profile edge top
- Integral covered .5B/0 profile edge backplash
- Applied .5B/0 profile edge endsplash

Series/Core Substrate Codes:

- PS80C** CARB particleboard
- PS80M** Moisture-resistant/NAF particleboard
- PS80F** Fire-rated particleboard
- PS80P** Plywood

PS80C, PS80M, PS80F and PS80P available countertop thicknesses:
29mm (1-1/8")
38mm (1-1/2")

Drop edge available upon special request.

COUNTERTOPS

Solid Surface Series

PT = Solid Surface Top
PE = Solid Surface Endsplash



PS81

Example:
PS81C2913

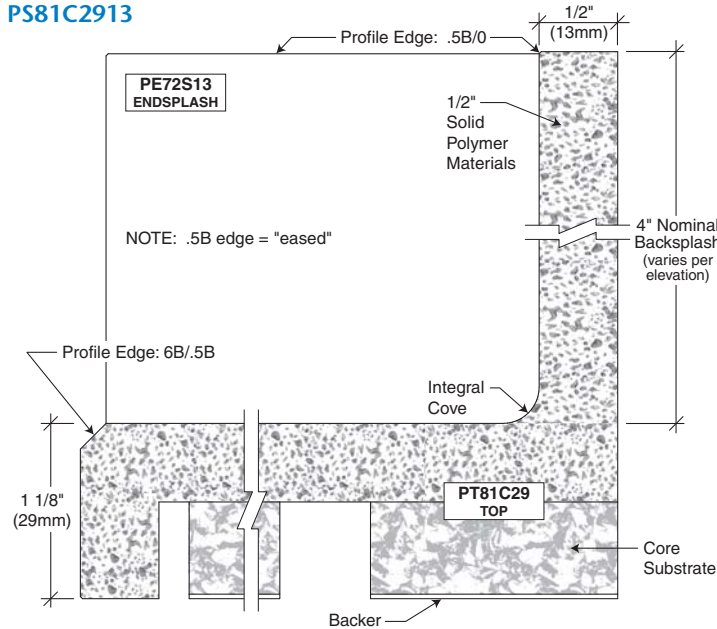

PS81 SOLID SURFACE

- Solid surface (polymer) materials
- 6B/.5B profile edge top
- Integral covered .5B/0 profile edge backsplash
- Applied .5B/0 profile edge endsplash

Series/Core Substrate Codes:

- PS81C** CARB particleboard
- PS81M** Moisture-resistant/NAF particleboard
- PS81F** Fire-rated particleboard
- PS81P** Plywood

PS81C, PS81M, PS81F and PS81P available countertop thicknesses:
 29mm (1-1/8")
 38mm (1-1/2")

Drop edge available upon special request.

PS82

Example:
PS82C2913

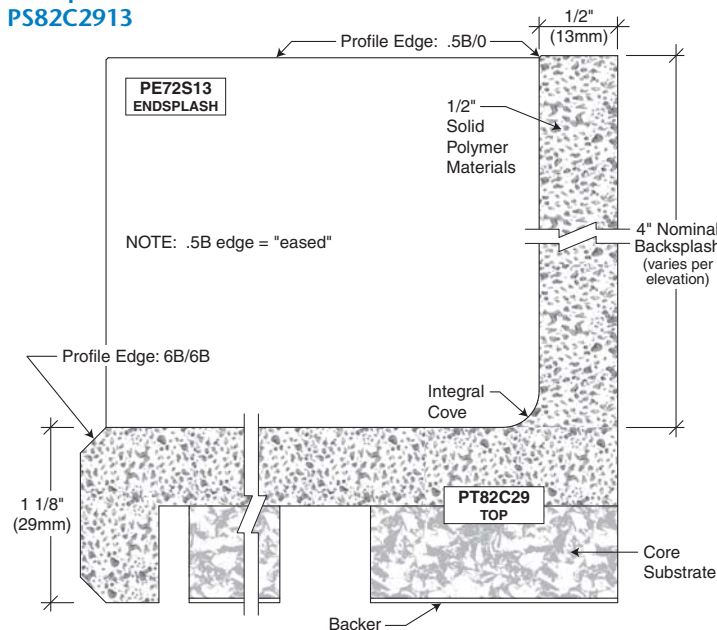

PS82 SOLID SURFACE

- Solid surface (polymer) materials
- 6B/6B profile edge top
- Integral covered .5B/0 profile edge backsplash
- Applied .5B/0 profile edge endsplash

Series/Core Substrate Codes:

- PS82C** CARB particleboard
- PS82M** Moisture-resistant/NAF particleboard
- PS82F** Fire-rated particleboard
- PS82P** Plywood

PS82C, PS82M, PS82F and PS82P available countertop thicknesses:
 29mm (1-1/8")
 38mm (1-1/2")

Drop edge available upon special request.

PT = Solid Surface Top
PE = Solid Surface Endsplash

PS83

Example:
PS83C2913

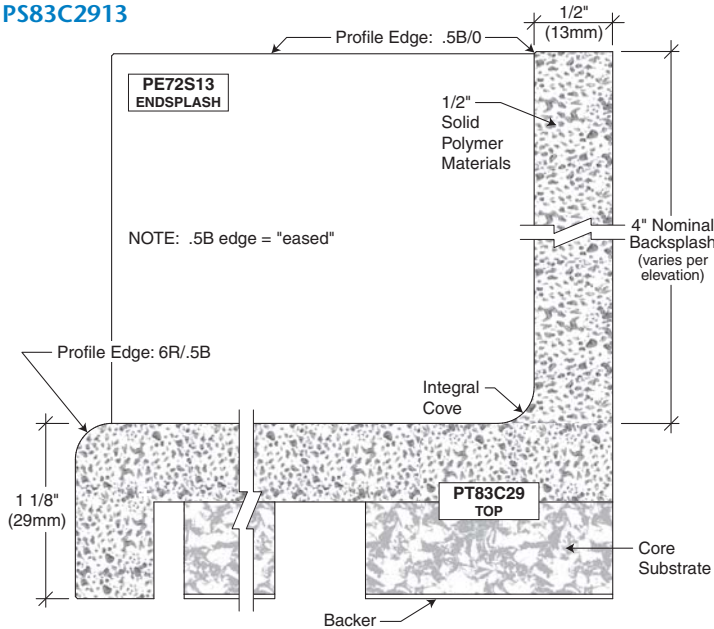

PS83 SOLID SURFACE

- Solid surface (polymer) materials
- 6R/.5B profile edge top
- Integral covered .5B/0 profile edge backsplash
- Applied .5B/0 profile edge endsplash

Series/Core Substrate Codes:

- PS83C** CARB particleboard
PS83M Moisture-resistant/NAF particleboard
PS83F Fire-rated particleboard
PS83P Plywood

PS83C, PS83M, PS83F and PS83P available countertop thicknesses:
 29mm (1-1/8")
 38mm (1-1/2")

Drop edge available upon special request.

PS84

Example:
PS84C2913

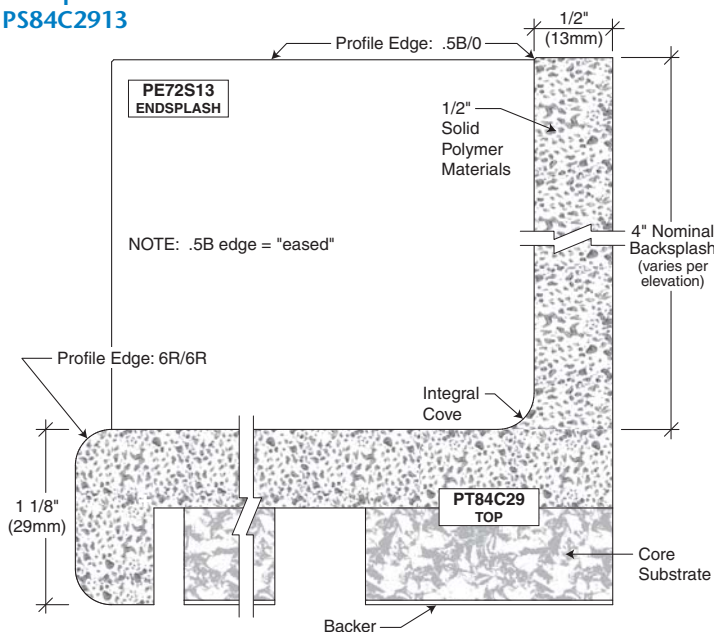

PS84 SOLID SURFACE

- Solid surface (polymer) materials
- 6R/6R profile edge top
- Integral covered .5B/0 profile edge backsplash
- Applied .5B/0 profile edge endsplash

Series/Core Substrate Codes:

- PS84C** CARB particleboard
PS84M Moisture-resistant/NAF particleboard
PS84F Fire-rated particleboard
PS84P Plywood

PS84C, PS84M, PS84F and PS84P available countertop thicknesses:
 29mm (1-1/8")
 38mm (1-1/2")

Drop edge available upon special request.

COUNTERTOPS

Solid Surface Series

PT = Solid Surface Top
PE = Solid Surface Endsplash



PS85

Example:
PS85C2913

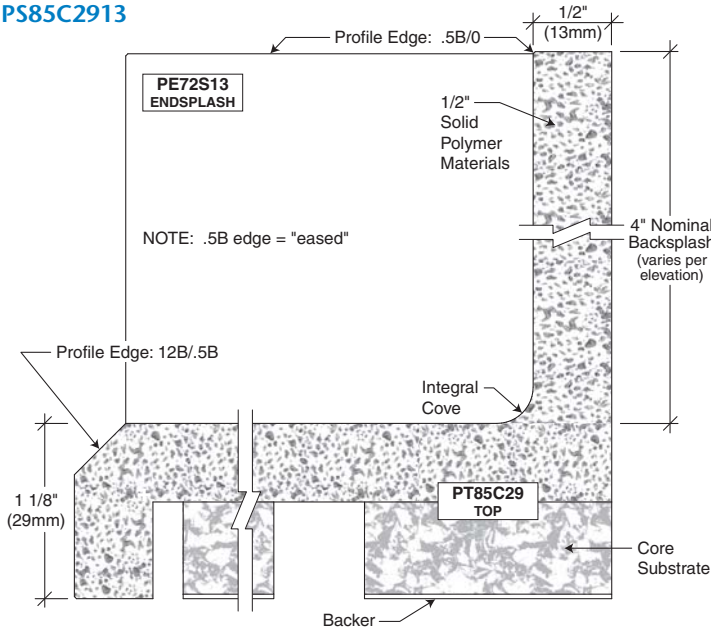

PS85 SOLID SURFACE

- Solid surface (polymer) materials
- 12B/.5B profile edge top
- Integral cove .5B/0 profile edge backsplash
- Applied .5B/0 profile edge endsplash

Series/Core Substrate Codes:

- PS85C** CARB particleboard
- PS85M** Moisture-resistant/NAF particleboard
- PS85F** Fire-rated particleboard
- PS85P** Plywood

PS85C, PS85M, PS85F and PS85P available countertop thicknesses:
29mm (1-1/8")
38mm (1-1/2")

Drop edge available upon special request.

PS86

Example:
PS86C2913

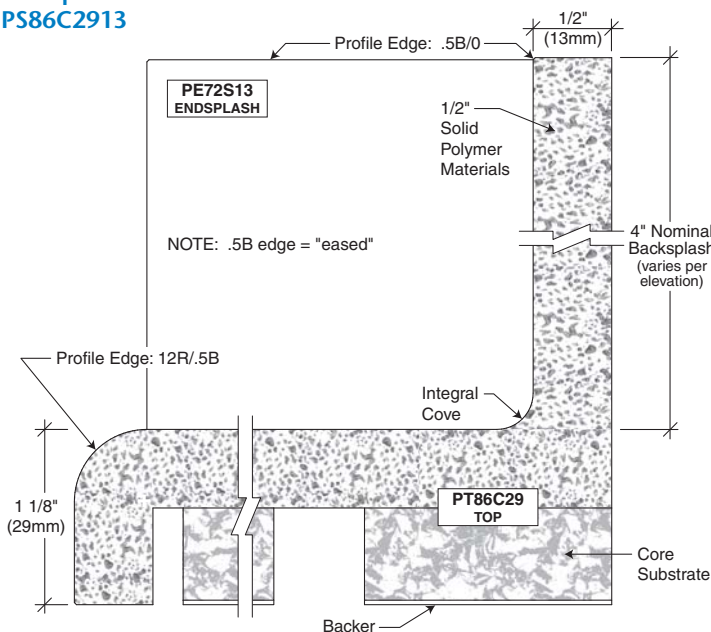

PS86 SOLID SURFACE

- Solid surface (polymer) materials
- 12R/.5B profile edge top
- Integral cove .5B/0 profile edge backsplash
- Applied .5B/0 profile edge endsplash

Series/Core Substrate Codes:

- PS86C** CARB particleboard
- PS86M** Moisture-resistant/NAF particleboard
- PS86F** Fire-rated particleboard
- PS86P** Plywood

PS86C, PS86M, PS86F and PS86P available countertop thicknesses:
29mm (1-1/8")
38mm (1-1/2")

Drop edge available upon special request.

PT = Solid Surface Top
PE = Solid Surface Endsplash

PS87

Example:
PS87C2913

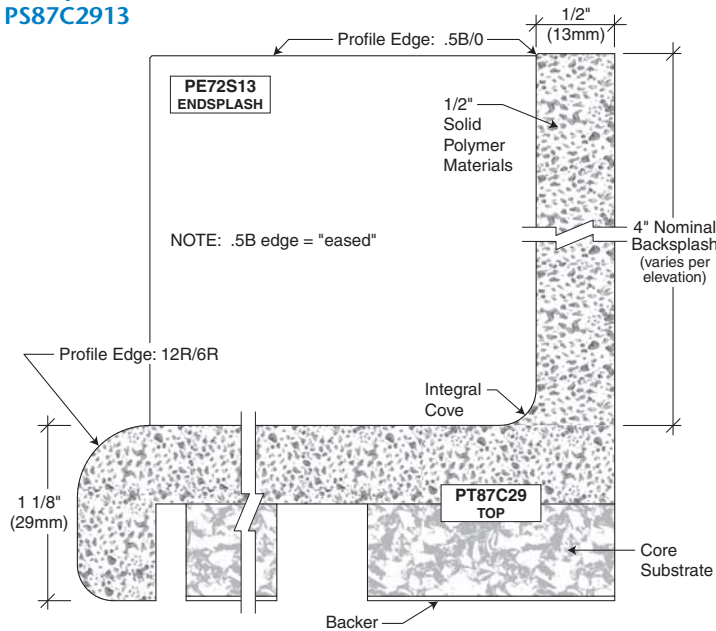

PS87 SOLID SURFACE

- Solid surface (polymer) materials
- 12R/6R profile edge top
- Integral covered .5B/0 profile edge backsplash
- Applied .5B/0 profile edge endsplash

Series/Core Substrate Codes:

- PS87C** CARB particleboard
PS87M Moisture-resistant/NAF particleboard
PS87F Fire-rated particleboard
PS87P Plywood

PS87C, PS87M, PS87F and PS87P available countertop thicknesses:
 29mm (1-1/8")
 38mm (1-1/2")

Drop edge available upon special request.

PS88

Example:
PS88C2913

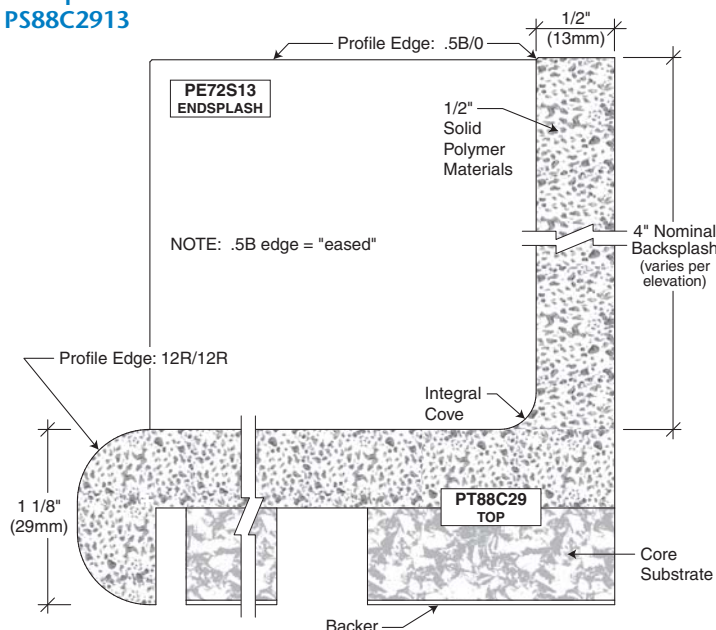

PS88 SOLID SURFACE

- Solid surface (polymer) materials
- 12R/12R profile edge top
- Integral covered .5B/0 profile edge backsplash
- Applied .5B/0 profile edge endsplash

Series/Core Substrate Codes:

- PS88C** CARB particleboard
PS88M Moisture-resistant/NAF particleboard
PS88F Fire-rated particleboard
PS88P Plywood

PS88C, PS88M, PS88F and PS88P available countertop thicknesses:
 29mm (1-1/8")
 38mm (1-1/2")

Drop edge available upon special request.

COUNTERTOPS

Solid Surface Series

PT = Solid Surface Top
PE = Solid Surface Endsplash



PS92

Example:
PS92C2913

PS92 SOLID SURFACE

- Solid surface (polymer) materials
- .5B/.5B profile edge top
- Integral covered .5B/0 profile edge backsplash
- Applied .5B/0 profile edge endsplash

Series/Core Substrate Codes:

- PS92C** CARB particleboard
PS92M Moisture-resistant/NAF particleboard
PS92F Fire-rated particleboard
PS92P Plywood

PS92C, PS92M, PS92F and PS92P available countertop thicknesses:
29mm (1-1/8")
38mm (1-1/2")

Drop edge available upon special request.

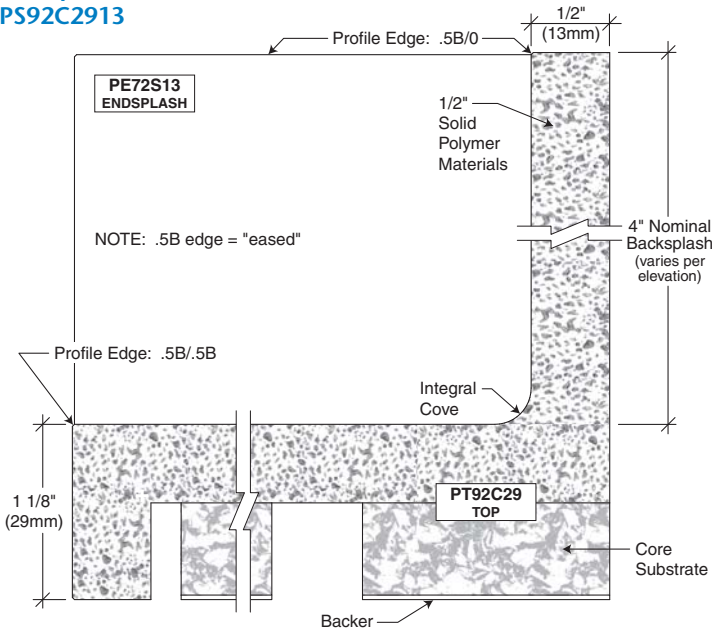

ET = Epoxy Top
EB = Epoxy Backsplash
EE = Epoxy Endsplash

ES00

Example:
ES00AW1919

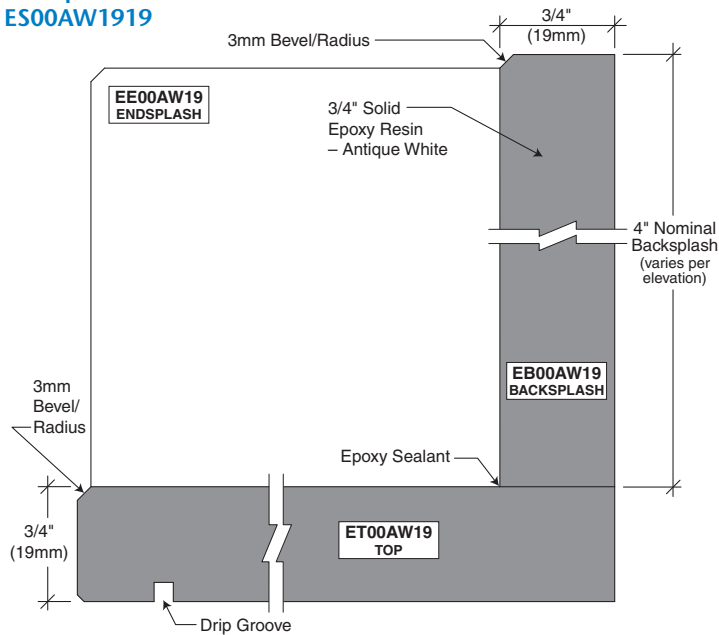

ES00 EPOXY RESIN

- Solid epoxy resin
- 3mm bevel/radius edges with smooth edge finish
- Applied backsplash and endsplash
- Drip groove
- Butt joints and attachment with field applied epoxy sealant and adhesives
- Epoxy resin coordinated sinks where specified
- Factory fabricated cutouts and drillings

Series/Color Codes:

ES00AW Antique White
ES00BL Black
ES00DK Dark Khaki
ES00GR Grey
ES00PL Platinum
ES00SA Sandstone

ES00 available countertop thicknesses:
19mm (3/4")
25mm (1")

ES01

Example:
ES01AW1919

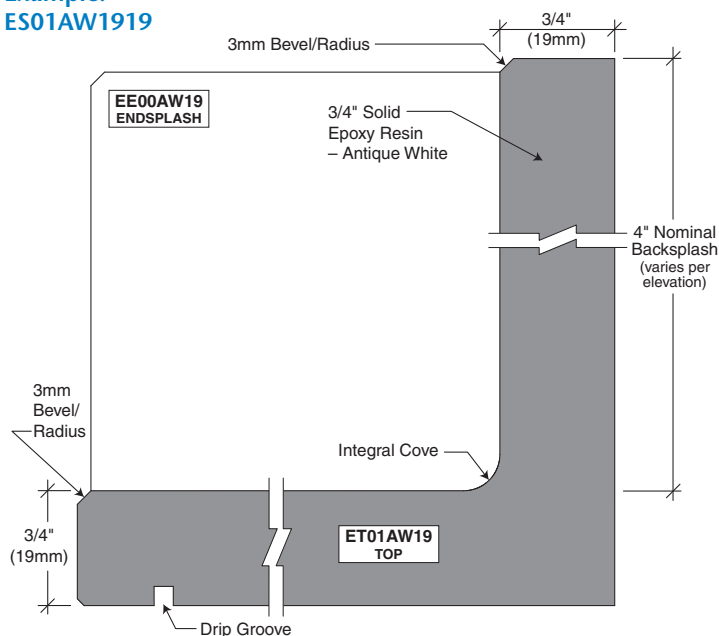

ES01 EPOXY RESIN

- Solid epoxy resin
- 3mm bevel/radius edges with smooth edge finish
- Integral covered backsplash
- Applied endsplash
- Drip groove
- Butt joints and attachment with field applied epoxy sealant and adhesives
- Epoxy resin coordinated sinks where specified
- Factory fabricated cutouts and drillings

Series/Color Codes:

ES01AW Antique White
ES01BL Black
ES01DK Dark Khaki
ES01GR Grey
ES01PL Platinum
ES01SA Sandstone

ES01 available countertop thicknesses:
19mm (3/4")
25mm (1")

COUNTERTOPS

Epoxy Resin Series

ET = Epoxy Top
 EB = Epoxy Backsplash
 EE = Epoxy Endsplash



ES02

Example:
 ES02AW2519

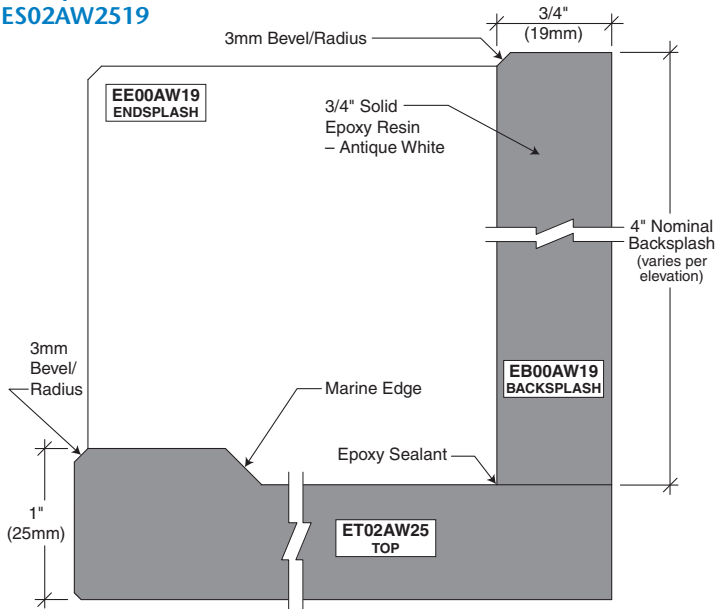

ES02 EPOXY RESIN

- Solid epoxy resin
- Lipped marine edge
- 3mm bevel/radius edges with smooth edge finish
- Applied backsplash and endsplash
- ~~Drip groove~~
- Butt joints and attachment with field applied epoxy sealant and adhesives
- Epoxy resin coordinated sinks where specified
- Factory fabricated cutouts and drillings

Series/Color Codes:

- ES02AW Antique White
- ES02BL Black
- ES02DK Dark Khaki
- ES02GR Grey
- ES02PL Platinum
- ES02SA Sandstone

ES02 available countertop thickness:
 25mm (1")

ES03

Example:
 ES03AW2519

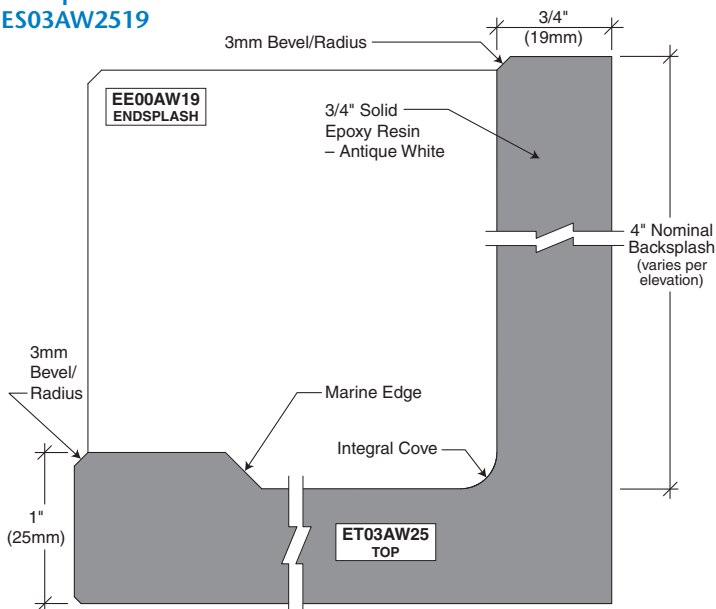

ES03 EPOXY RESIN

- Solid epoxy resin
- Lipped marine edge
- 3mm bevel/radius edges with smooth edge finish
- Integral covered backsplash
- Applied endsplash
- ~~Drip groove~~
- Butt joints and attachment with field applied epoxy sealant and adhesives
- Epoxy resin coordinated sinks where specified
- Factory fabricated cutouts and drillings

Series/Color Codes:

- ES03AW Antique White
- ES03BL Black
- ES03DK Dark Khaki
- ES03GR Grey
- ES03PL Platinum
- ES03SA Sandstone

ES03 available countertop thickness:
 25mm (1")

WT = Hardwood Top
WB = Hardwood Backsplash
WE = Hardwood Endsplash

WD00

Example:
WD00S3819

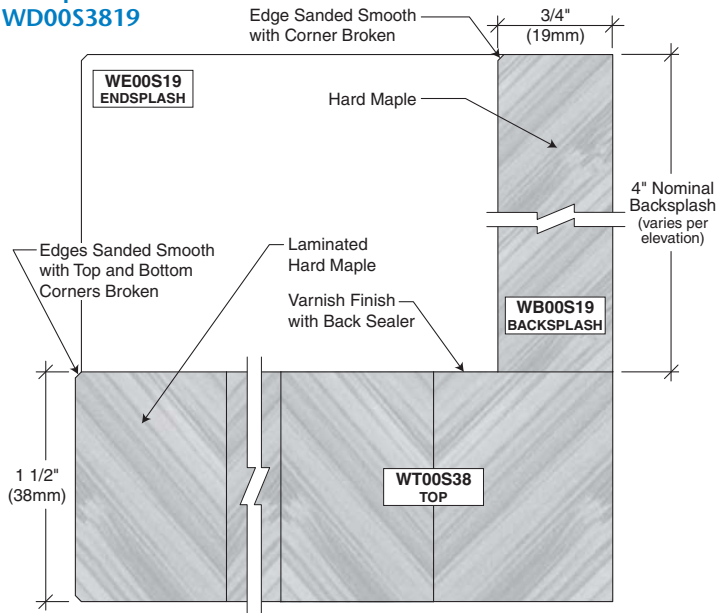

WD00 HARDWOOD

- Fabricated from laminated kiln dried hard maple lumber
- Industrial grade with butt joints and edge grain fabrication (butcher block) design
- Edges sanded smooth with top and bottom corners broken
- Faces and edges sealed with varnish finish

Series/Core Code:

WD00S Solid hard maple

WD00S available countertop thicknesses:

38mm (1-1/2")

44mm (1-3/4")

Note: Laminated maple lumber tops are susceptible to changes due to moisture, heat and cold conditions. Warpage and edge splitting may occur under unusual field conditions. Wood tops should only be delivered and installed after project HVAC systems are working and balanced for normal interior conditions. Never store or use in high or low humidity with cyclical conditions.

COUNTERTOPS

Workbench Series

BT = Workbench Top
BB = Workbench Backsplash
BE = Workbench Endsplash



BW00

Example:
BW00C3820

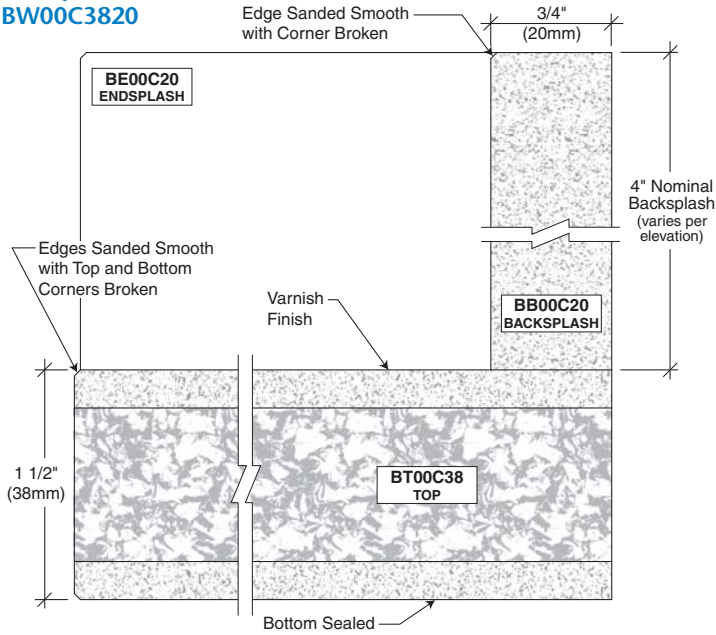

BW00 WORKBENCH

- Countertop: laminated 3-piece construction with CARB particleboard core and 1/4" MDF top and bottom faces
- Applied backsplash and endsplash: MDF
- Edges sanded smooth with top and bottom corners broken
- Top face and edges with varnish finish
- Bottom face sealed

Series/Core Code:

BW00C CARB particleboard

BW00C available countertop thickness:
38mm (1-1/2")

ST = Stainless Steel Top

SS00

Example:
SS00P2725

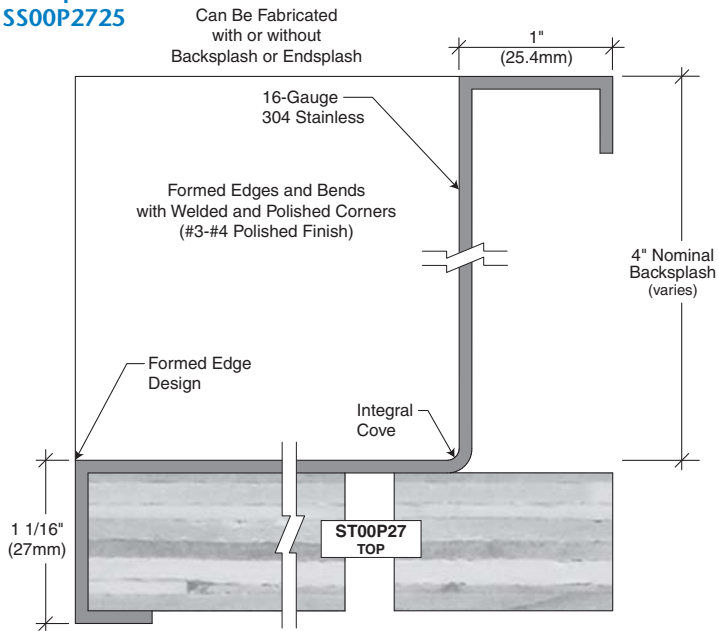

SS00 STAINLESS STEEL

- Formed edge design with integral cove
- Fabricated from 16-gauge 304 stainless steel
- Formed edges and bends with welded and polished corners
- Can be fabricated with or without backsplash or endsplash

Series/Core Codes:

SS00P Plywood
SS00R Stainless Steel Rail

SS00P and **SS00R** available countertop thickness: 27mm (1-1/16")

Example:
SS00R2725

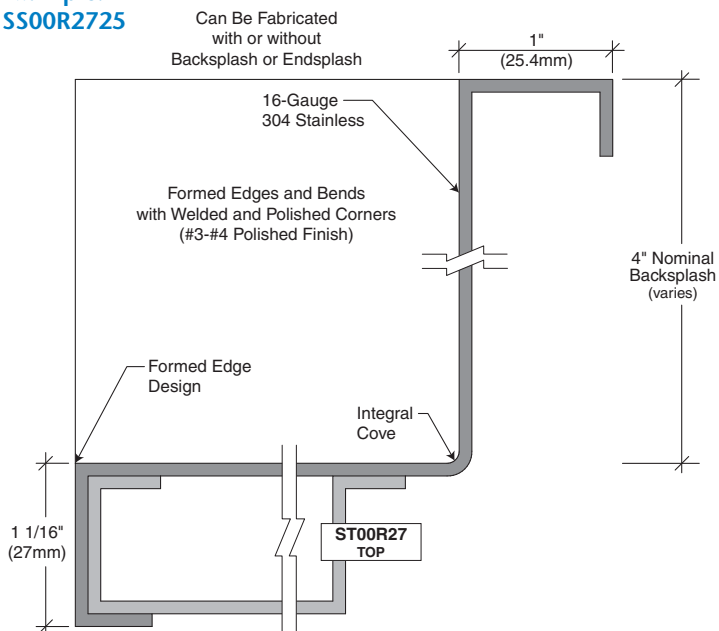

COUNTERTOPS

Stainless Steel Series

ST = Stainless Steel Top



SS01

Example:
SS01P3225

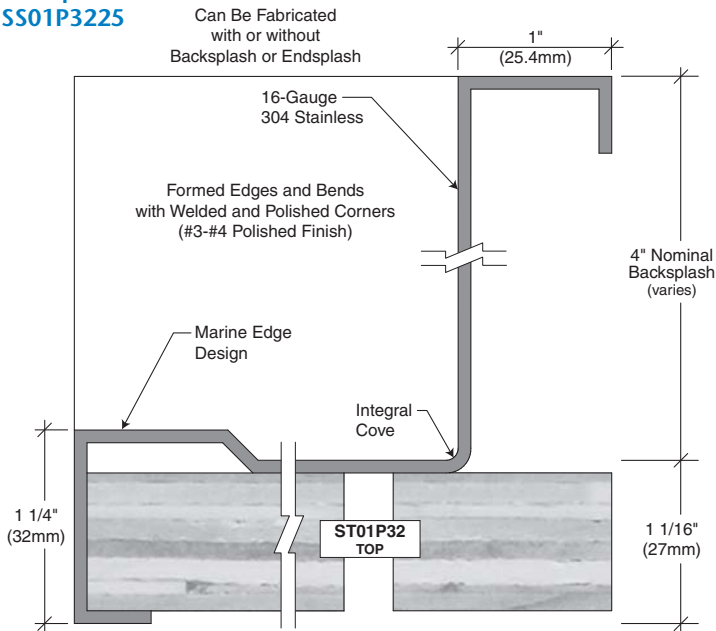

SS01 STAINLESS STEEL

- Marine edge design with integral cove
- Fabricated from 16-gauge 304 stainless steel
- Formed edges and bends with welded and polished corners
- Can be fabricated with or without backsplash or endsplash

Series/Core Codes:

- SS01P Plywood
SS01R Stainless Steel Rail

SS01P and SS01R available countertop thickness:
32mm (1-1/4")

Example:
SS01R3225

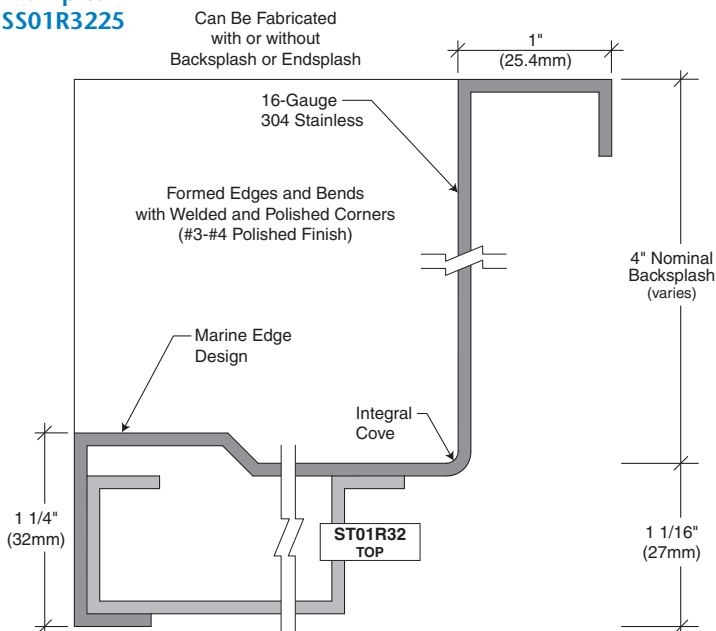

AT = Phenolic Top
AB = Phenolic Backsplash
AE = Phenolic Endsplash

AP00

Example:
AP00S1919

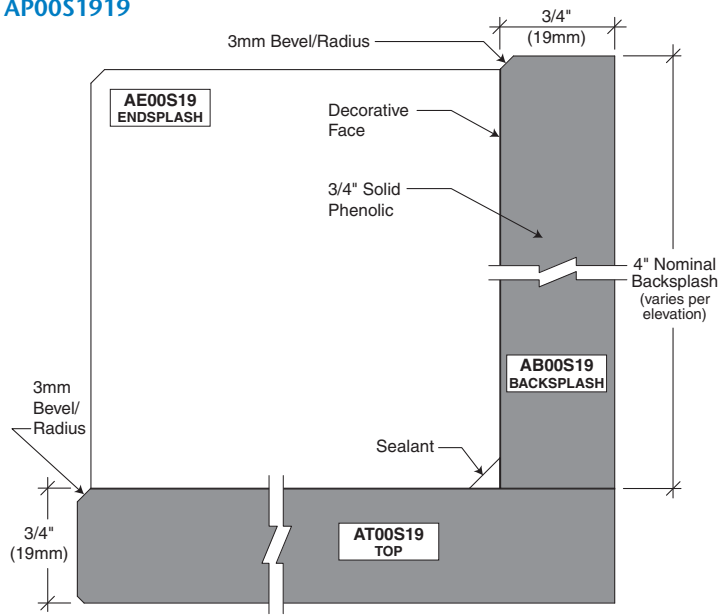

AP00 PHENOLIC

- Solid phenolic core with decorative face pattern
- 3mm bevel/radius edges, polished for consistent edge look
- Applied backsplash and endsplash

Series/Core Code:

AP00S Solid

AP00S available countertop thickness:
19mm (3/4")

AP01

Example:
AP01S1919

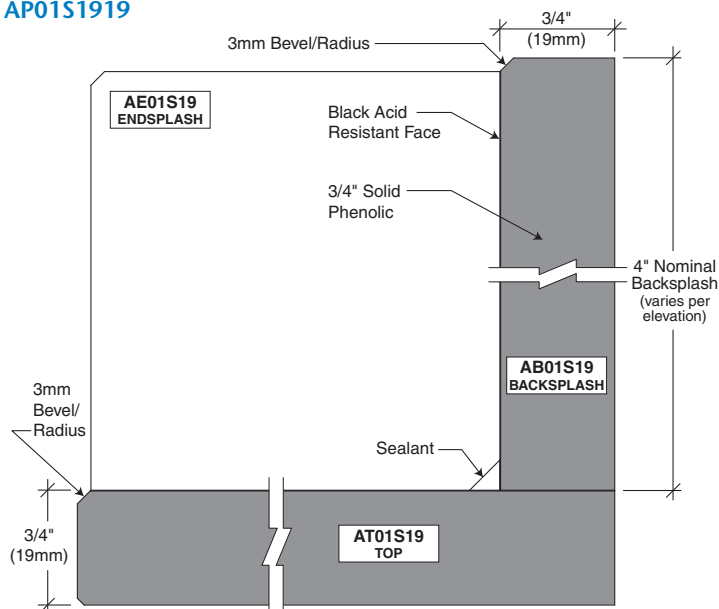

AP01 PHENOLIC

- Solid phenolic core with black acid resistant face
- 3mm bevel/radius edges, polished for consistent edge look
- Applied backsplash and endsplash

Series/Core Code:

AP01S Solid

AP01S available countertop thickness:
19mm (3/4")

COUNTERTOPS

Phenolic Series

AT = Phenolic Top
 AB = Phenolic Backsplash
 AE = Phenolic Endsplash



AP02

Example:
 AP02S1919

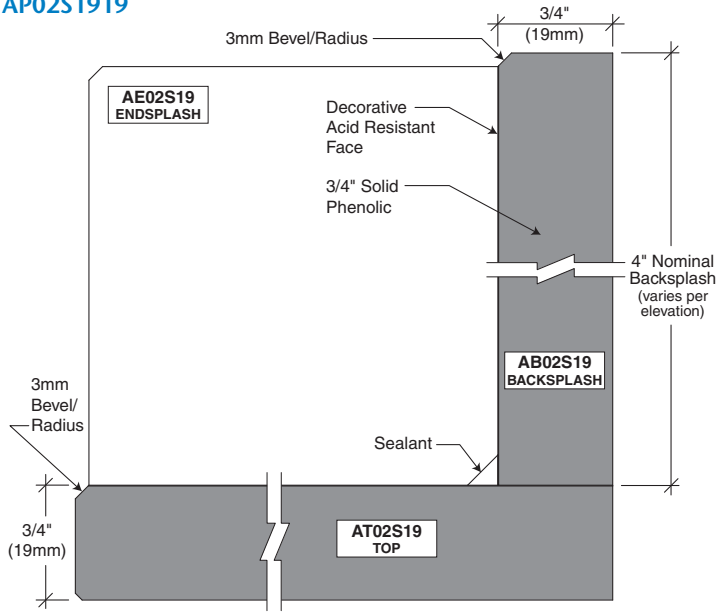

AP02 PHENOLIC

- Solid phenolic core with decorative acid resistant face
- 3mm bevel/radius edges, polished for consistent edge look
- Applied backsplash and endsplash

Series/Core Code:

AP02S Solid

AP02S available countertop thickness:
 19mm (3/4")

AP03

Example:
 AP03S1919

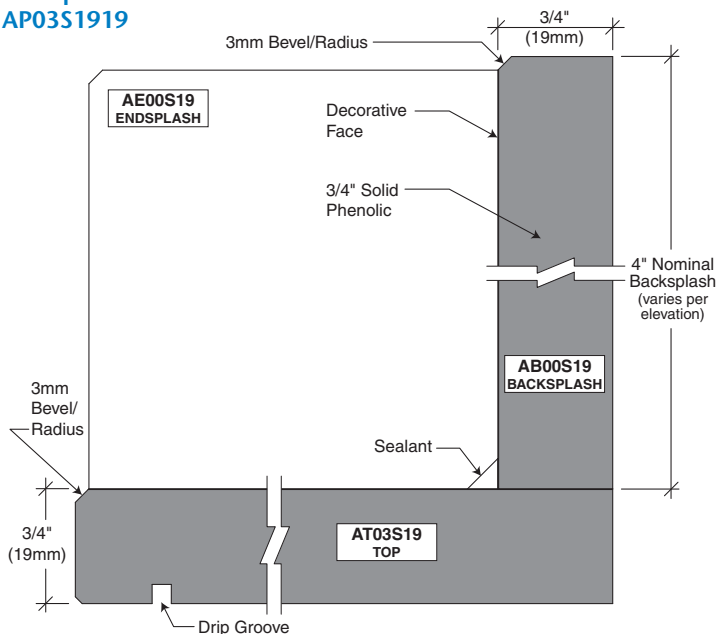

AP03 PHENOLIC

- Solid phenolic core with decorative face pattern
- 3mm bevel/radius edges, polished for consistent edge look
- Applied backsplash and endsplash
- Drip groove

Series/Core Code:

AP03S Solid

AP03S available countertop thickness:
 19mm (3/4")

AT = Phenolic Top
AB = Phenolic Backsplash
AE = Phenolic Endsplash

AP04

Example:
AP04S1919

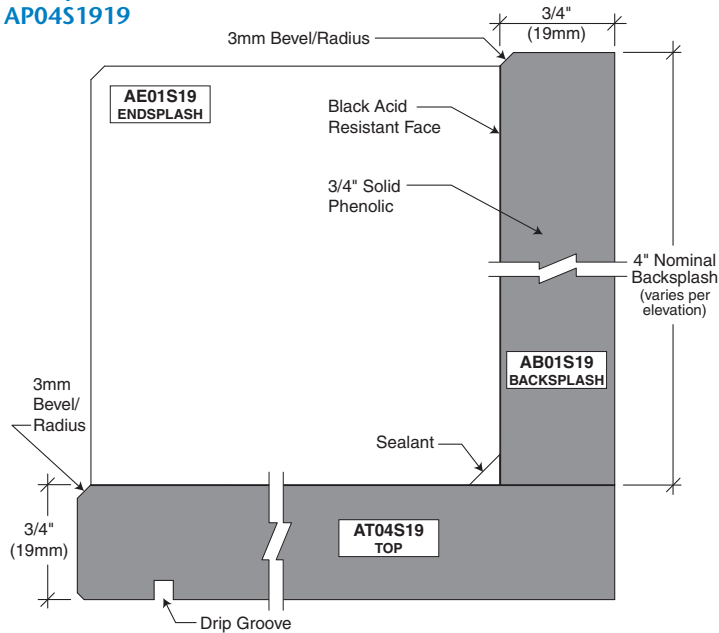

AP04 PHENOLIC

- Solid phenolic core with black acid resistant face
- 3mm bevel/radius edges, polished for consistent edge look
- Applied backsplash and endsplash
- Drip groove

Series/Core Code:

AP04S Solid

AP04S available countertop thickness:
19mm (3/4")

AP05

Example:
AP05S1919

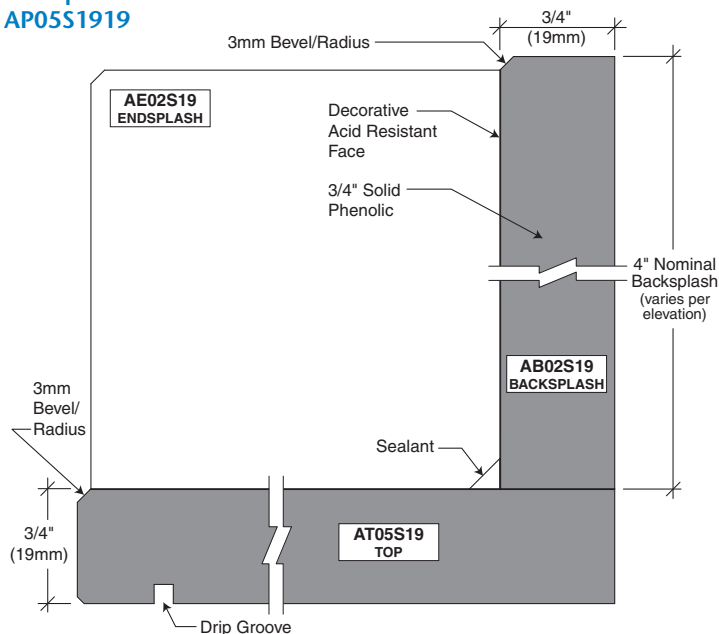

AP05 PHENOLIC

- Solid phenolic core with decorative acid resistant face
- 3mm bevel/radius edges, polished for consistent edge look
- Applied backsplash and endsplash
- Drip groove

Series/Core Code:

AP05S Solid

AP05S available countertop thickness:
19mm (3/4")

COUNTERTOPS

Granite Series

GT = Granite Top
 GB = Granite Backsplash
 GE = Granite Endsplash



GS00

Example:
 GS00S2020

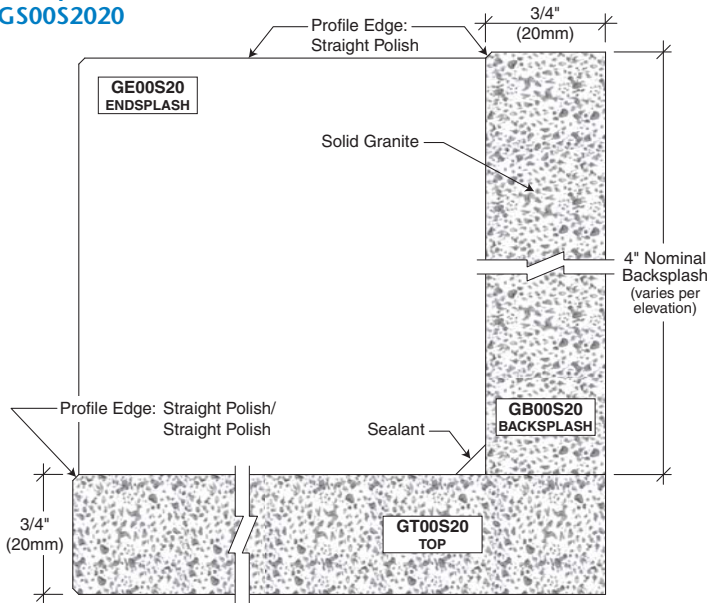

GS00 GRANITE

- Solid granite
- Straight Polish/Straight Polish profile edge top
- Applied Straight Polish profile edge backsplash and endsplash

Series/Core Code:

GS00S Solid

GS00S available countertop thicknesses:

- 20mm (3/4")
- 30mm (1-3/16")

GS01

Example:
 GS01S2020

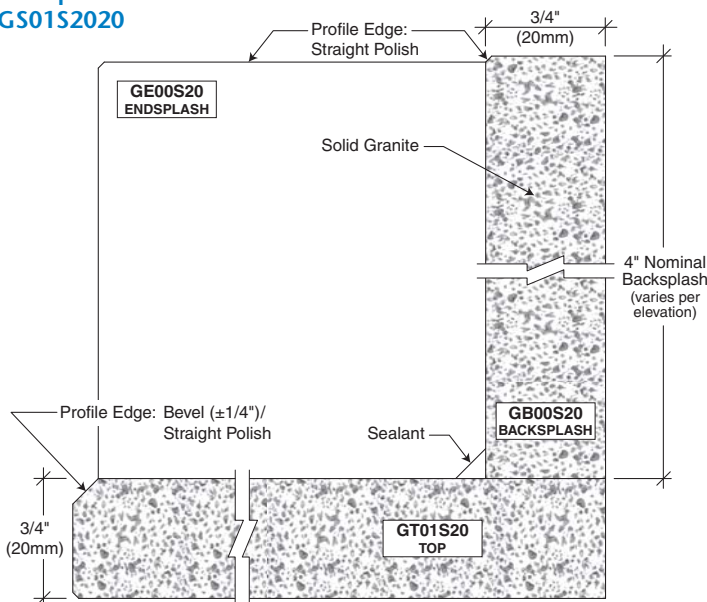

GS01 GRANITE

- Solid granite
- Bevel ($\pm 1/4$ ")/Straight Polish profile edge top
- Applied Straight Polish profile edge backsplash and endsplash

Series/Core Code:

GS01S Solid

GS01S available countertop thicknesses:

- 20mm (3/4")
- 30mm (1-3/16")

GT = Granite Top
GB = Granite Backsplash
GE = Granite Endsplash

GS02

Example:
GS02S2020

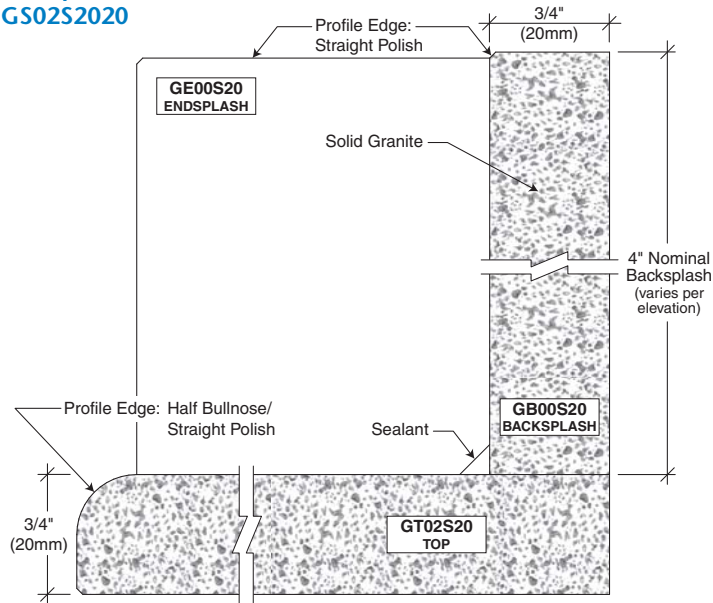

GS02 GRANITE

- Solid granite
- Half Bullnose/Straight Polish profile edge top
- Applied Straight Polish profile edge backsplash and endsplash

Series/Core Code:

GS02S Solid

GS02S available countertop thicknesses:

- 20mm (3/4")
- 30mm (1-3/16")

COUNTERTOPS

Marble Series

MT = Marble Top
 MB = Marble Backsplash
 ME = Marble Endsplash



MS00

Example:
 MS00S2020

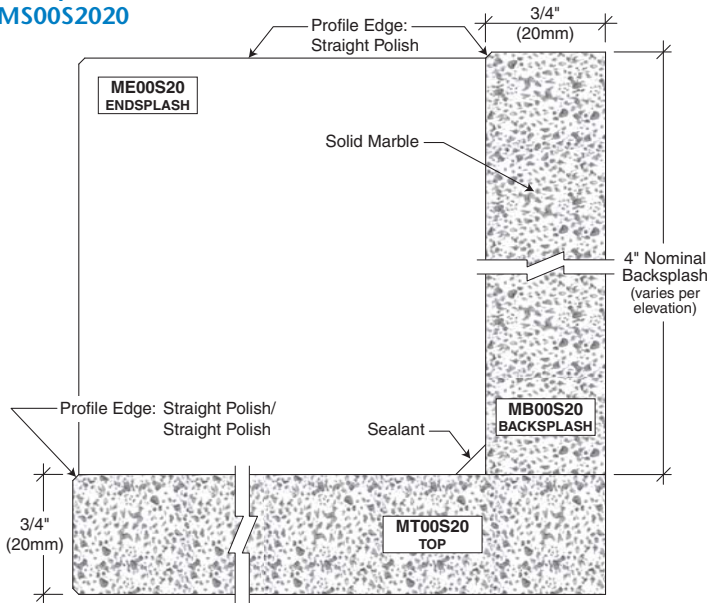

MS00 MARBLE

- Solid marble
- Straight Polish/Straight Polish profile edge top
- Applied Straight Polish profile edge backsplash and endsplash

Series/Core Code:

MS00S Solid

MS00S available countertop thicknesses:

- 20mm (3/4")
- 30mm (1-3/16")

MS01

Example:
 MS01S2020

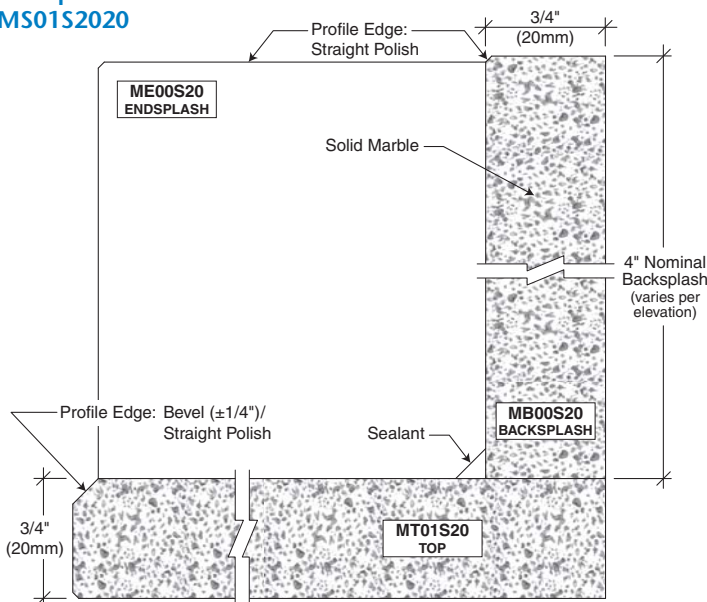

MS01 MARBLE

- Solid marble
- Bevel ($\pm 1/4$ ")/Straight Polish profile edge top
- Applied Straight Polish profile edge backsplash and endsplash

Series/Core Code:

MS01S Solid

MS01S available countertop thicknesses:

- 20mm (3/4")
- 30mm (1-3/16")

MT = Marble Top
MB = Marble Backsplash
ME = Marble Endsplash

MS02

Example:
MS02S2020

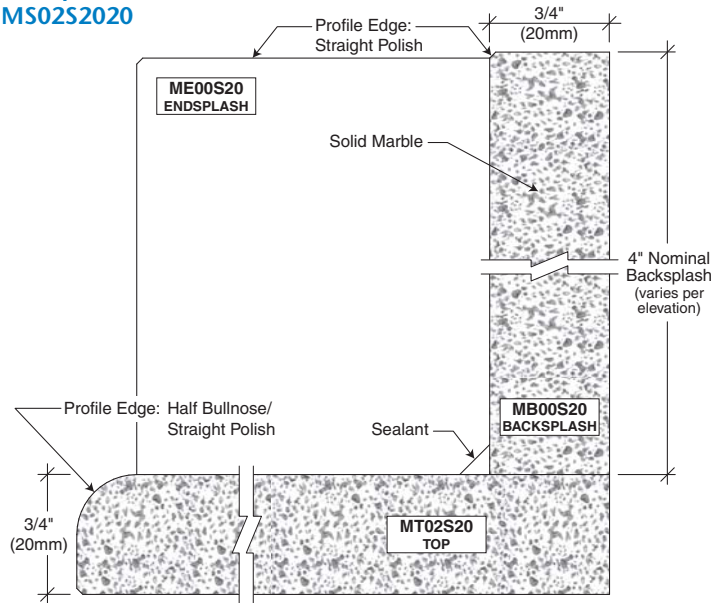

MS02 MARBLE

- Solid marble
- Half Bullnose/Straight Polish profile edge top
- Applied Straight Polish profile edge backsplash and endsplash

Series/Core Code:

MS02S Solid

MS02S available countertop thicknesses:

- 20mm (3/4")
- 30mm (1-3/16")

COUNTERTOPS

Quartz Series

QT = Quartz Top
QB = Quartz Backsplash
QE = Quartz Endsplash



QS00

Example:
 QS00S2020

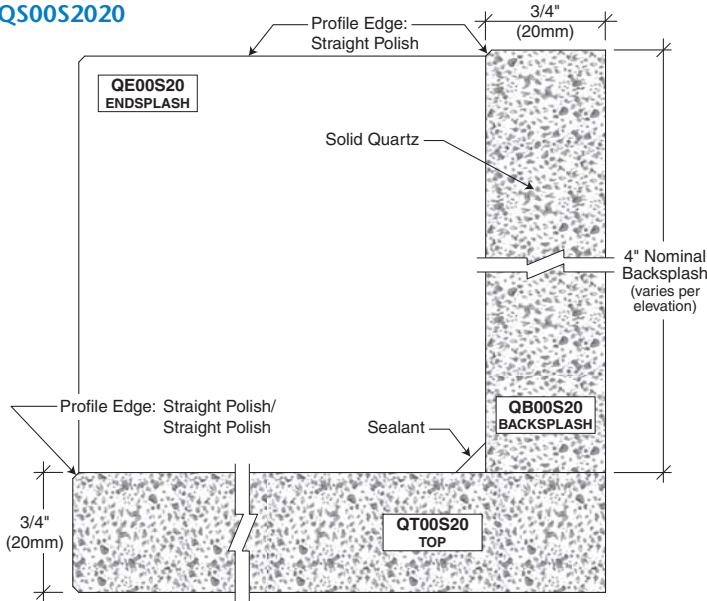

QS00 QUARTZ

- Solid quartz
- Straight Polish/Straight Polish profile edge top
- Applied Straight Polish profile edge backsplash and endsplash

Series/Core Code:

QS00S Solid

QS00S available countertop thicknesses:

- 20mm (3/4")
- 30mm (1-3/16")

QS01

Example:
 QS01S2020

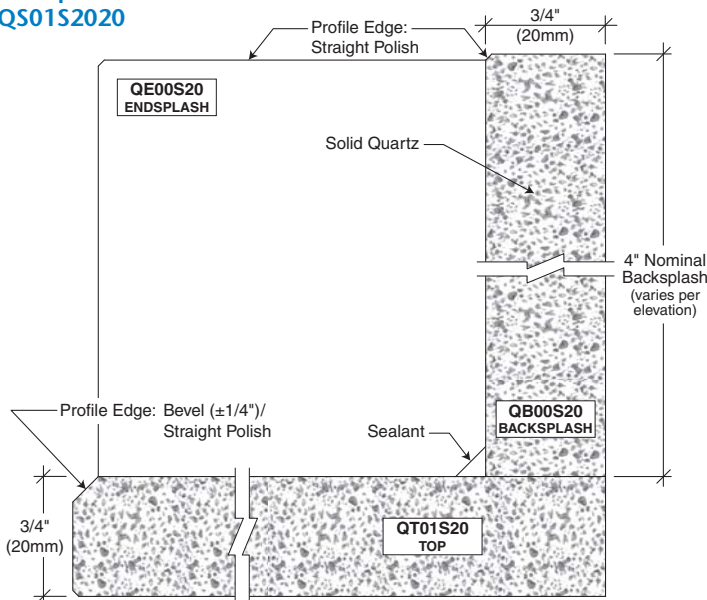

QS01 QUARTZ

- Solid quartz
- Bevel ($\pm 1/4$ ")/Straight Polish profile edge top
- Applied Straight Polish edge backsplash and endsplash

Series/Core Code:

QS01S Solid

QS01S available countertop thicknesses:

- 20mm (3/4")
- 30mm (1-3/16")

QT = Quartz Top
QB = Quartz Backsplash
QE = Quartz Endsplash

QS02

Example:
QS02S2020

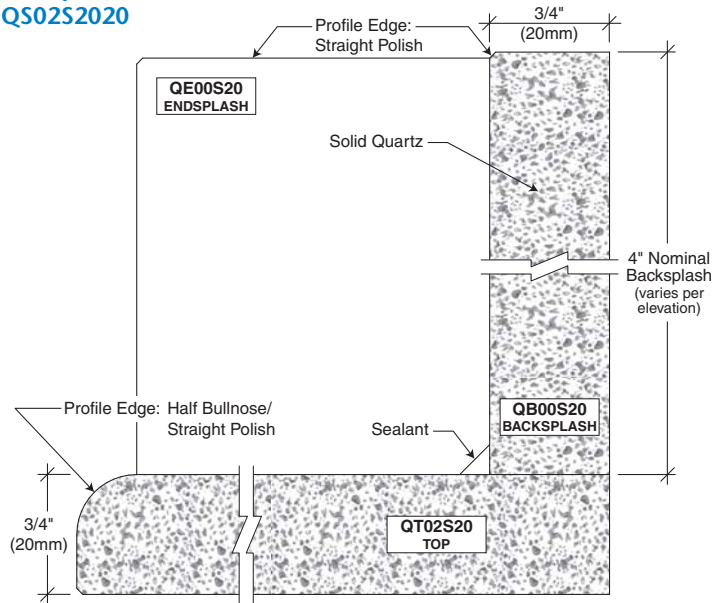

QS02 QUARTZ

- Solid quartz
- Half Bullnose/Straight Polish profile edge top
- Applied Straight Polish profile edge backsplash and endsplash

Series/Core Code:

QS02S Solid

QS02S available countertop thicknesses:

- 20mm (3/4")
- 30mm (1-3/16")

WINDOWSILLS

Laminate Series

LT = Laminate Top



LS50

Example:
LS50C27

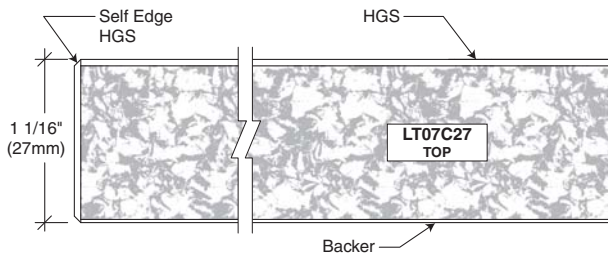

LS50 LAMINATE WINDOWSILL

- Self edge

Series/Core Codes:

- LS50C** CARB particleboard
- LS50M** Moisture-resistant/NAF particleboard
- LS50F** Fire-rated particleboard
- LS50P** Plywood

LS50C, LS50M and LS50F available windowsill thickness:

- 21mm (13/16")
- 27mm (1-1/16")
- 40mm (1-9/16")

LS50C special order windowsill thickness:

- 30mm (1-3/16")

LS50P available windowsill thicknesses:

- 20mm (3/4")
- 27mm (1-1/16")
- 40mm (1-9/16")

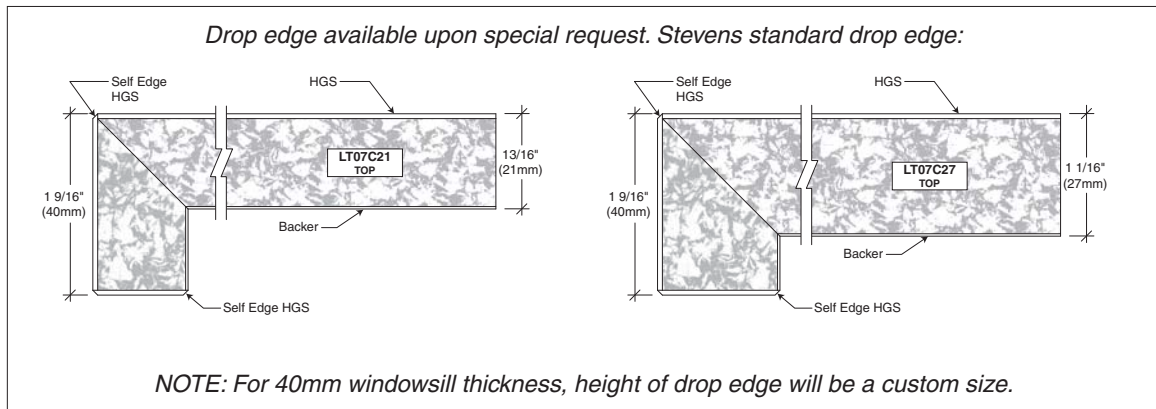

LT = Laminate Top

LS51

Example:
LS51C27

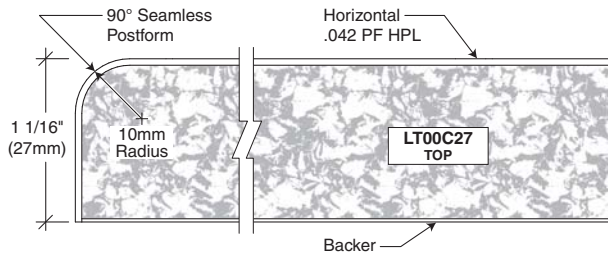

LS51 LAMINATE WINDOWSILL

- 90° postform edge

Series/Core Codes:

- LS51C** CARB particleboard
- LS51M** Moisture-resistant/NAF particleboard
- LS51F** Fire-rated particleboard

LS51C, LS51M and **LS51F** available windowsill thickness:

- 21mm (13/16")
- 27mm (1-1/16")
- 40mm (1-9/16")

LS51C special order windowsill thickness:
30mm (1-3/16")

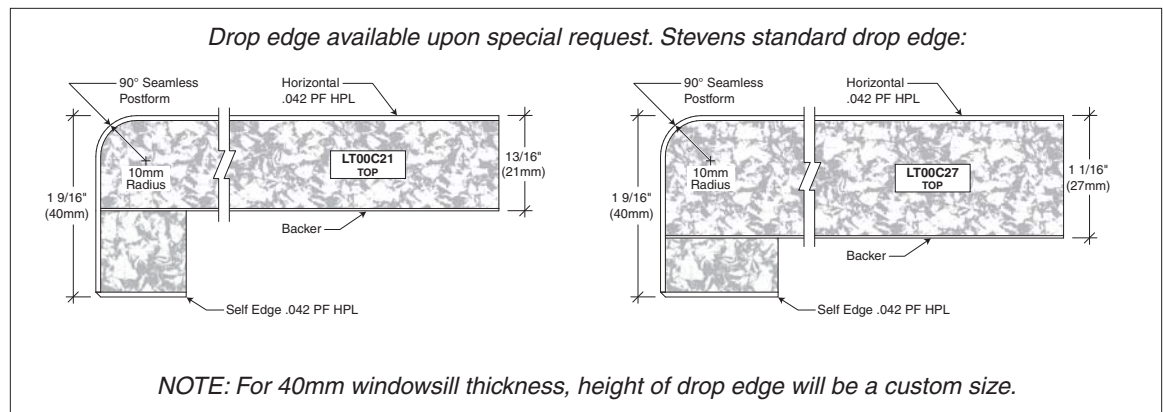

WINDOWSILLS

Laminate Series

LT = Laminate Top



LS52

Example:
LS52C27

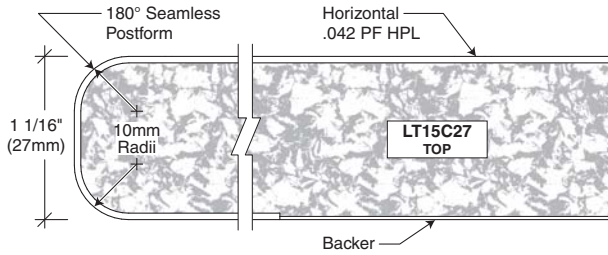

LS52 LAMINATE WINDOWSILL

- 180° postform edge

Series/Core Codes:

- LS52C** CARB particleboard
- LS52M** Moisture-resistant/NAF particleboard
- LS52F** Fire-rated particleboard

LS52C, LS52M and **LS52F** available windowsill thickness:

- 21mm (13/16")
- 27mm (1-1/16")
- 40mm (1-9/16")

LS52C special order windowsill thickness:
30mm (1-3/16")

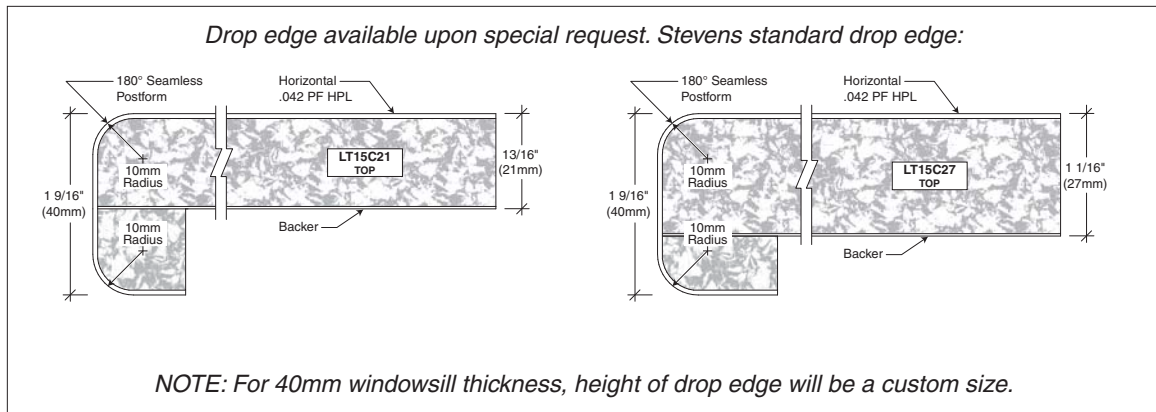

PT = Solid Surface Top

PS10

Example:
PS10S13

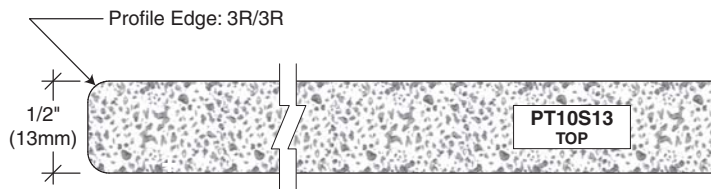

PS10 SOLID SURFACE WINDOWSILL

- Solid surface (polymer) materials
- 3R/3R profile edge

Series/Core Code:

PS10S Solid

PS10S available thickness:
13mm (1/2")

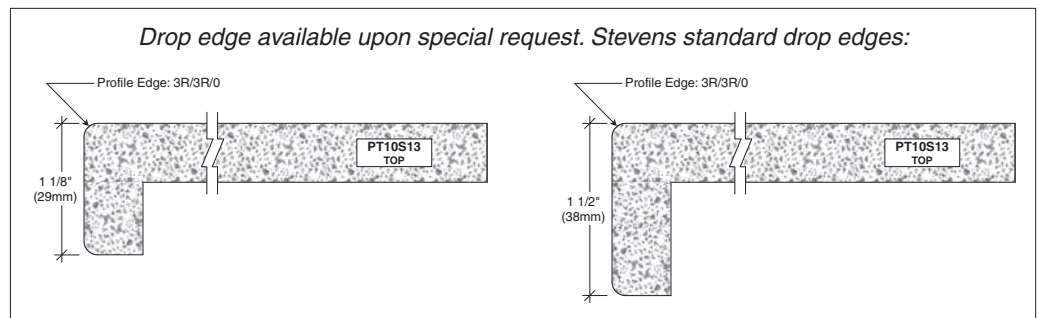

PS11

Example:
PS11S13

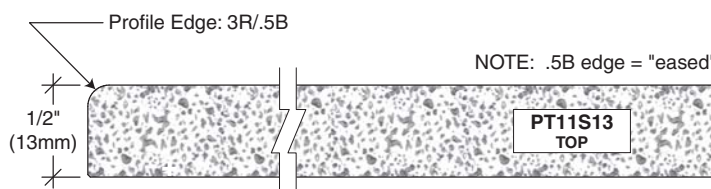

PS11 SOLID SURFACE WINDOWSILL

- Solid surface (polymer) materials
- 3R/.5B profile edge

Series/Core Code:

PS11S Solid

PS11S available thickness:
13mm (1/2")

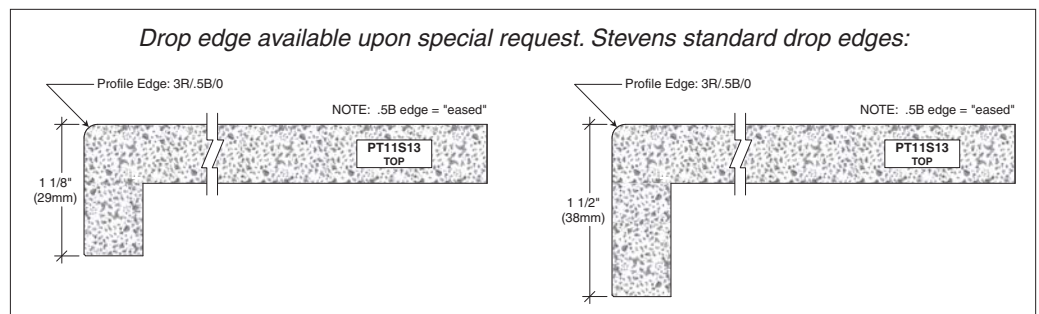

WINDOWSILLS

Solid Surface Series

PT = Solid Surface Top



PS12

Example:
PS12S13

PS12 SOLID SURFACE WINDOWSILL

- Solid surface (polymer) materials
- 6R/6R profile edge

Series/Core Code:

PS12S Solid

PS12S available thickness:
13mm (1/2")

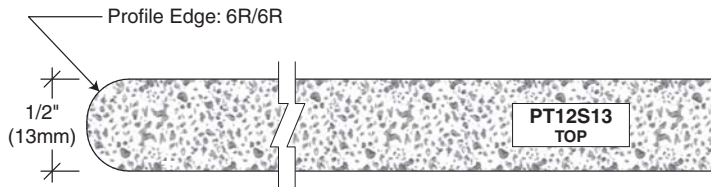

PS13

Example:
PS13S13

PS13 SOLID SURFACE WINDOWSILL

- Solid surface (polymer) materials
- .5B/.5B profile edge

Series/Core Code:

PS13S Solid

PS13S available thickness:
13mm (1/2")

